

Installation Manual
THM-0300 Programmable Thermostat
Version 1.27

The logo features the letters 'HBX' in a bold, black, sans-serif font. The letters are centered within a white rectangular area. This white area is flanked by two horizontal red bars, one above and one below the text. The entire logo is set against a background of a wide, horizontal band with a complex, wavy, grid-like pattern in shades of beige and brown.

THM-0300

HBX Control Systems Inc.

TABLE OF CONTENTS

Introduction	Index
Safety symbols and Warnings	Index
Receipt and Inspection	1
Description	1
Technical data and dimensions	1
Programming THM-0300	2 - 12
- Navigating the THM-0300	2
- Setting the THM-0300	2 - 4
- Special Functions	2 - 6
- Setup Menu	6 - 13
Installation and Wiring	14-16
Limited Warranty	17

INTRODUCTION

This manual will help with the installation, parameter setting, troubleshooting and general maintenance requirements for the Controller. To guarantee the safe and reliable operation of this Control, you must first read this manual in detail and take particular note to any and all warnings or caution directives prior to connecting to AC power.

Only suitably qualified individuals with formal training in electrical and HVAC controls should attempt the installation of this equipment. Incorrect wiring and installation will affect the warranty provided with this unit. Wiring must be completed in accordance with the codes and practices applicable to the jurisdiction for the actual installation.

The HBX THM-0300 is a microprocessor based controller and as such is not to be regarded as a safety (limit) control. Please consult and install the heating or cooling appliance in accordance with the manufacturer's recommendations.



SAFETY SYMBOLS AND WARNINGS

DRAWING REFERENCE

Refer to the specified electrical or mechanical drawing at the back of the manual.



PRECAUTION

A measure taken in advance to prevent dangerous or an unpleasant event



WARNING: This product can expose you to chemicals including lead, which is known to the State of California to cause cancer and birth defects or other reproductive harm. For more information go to www.P65Warnings.ca.gov.

RECEIPT & INSPECTION

After receiving, inspect the unit for any possible physical damage that may have occurred during transportation. After unpacking the unit make sure the box contains:

- 1 x Universal sensor (Part #029-0045)
- 1 x Thermostat THM-0300
- Instruction Manual

DESCRIPTION

The THM-0300 is a programmable thermostat designed to be used with the ZON-0550 Zone Control, optional Wi-Fi™ ThermoLinx™ Module, and HBX Wi-Fi mobile app. The thermostat has four daily, automatic settings (wake, day, evening, sleep) and weekend settings. It is normal for the THM-0300 screen to blink upon startup.

The THM-0300 has two external sensor inputs, multiple heating/cooling modes and can function as a digital setpoint/aquastat.

Some features of the THM-0300 are:

- Dual stage heating or cooling
- P.I.D. algorithm.
- Large backlit graphic display
- Push button keypad control
- User-friendly programming features
- Includes external sensor
- 2 wire thermostat (power and communication)



The THM-0300 is only compatible with the ZON-0550 Zone Control

TECHNICAL DATA AND DIMENSIONS

Technical Data

2 x External Thermistor Input
1 x Power and Communication:
5VDC

Dimensions: 115 x 80 x 27.5mm

ETL Listings:

Only used with ZON-0550
ETL Control No. 3068143

Storage: +10C to +40C

Languages: English

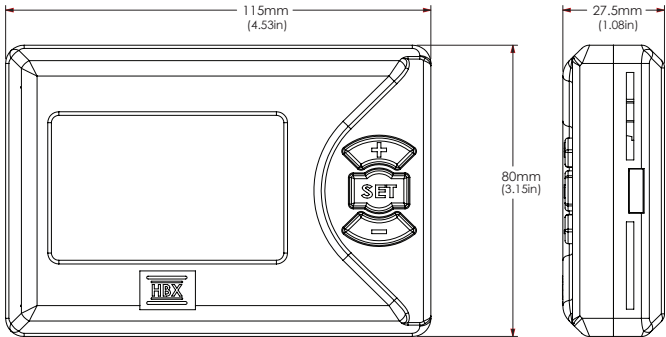

PROGRAMMING THM-0300

NAVIGATING THE THERMOSTAT

All programming steps within the thermostat are achieved by using the three buttons (and combinations thereof) located on the right-hand side of the thermostat.

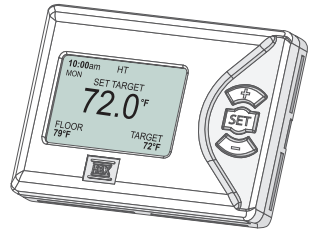

The + button is used to scroll up in menu screens and increase a value within specific options.

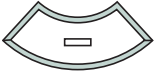

The - button is used to scroll down in menu screens and decrease a value within specific options.

Pressing the + or - button on their own for 2 seconds while viewing the main “**Status Screen**” will allow you to quickly adjust your target temperature. Once you have reached the desired target temperature by using the + and - buttons, waiting five seconds will return the thermostat to the initial “**Status Screen**” mode.

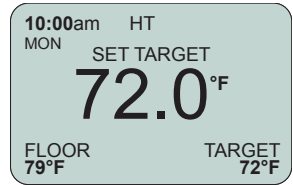

SETTING THE THERMOSTAT

Special Functions

Enter the “**Special Functions**” screen by holding down the + and - buttons simultaneously for 5 seconds (from the “**Status Screen**”). To select the desired option, use the + and - buttons to toggle and the **set** button to select.

Lockout Thermostat

In the special functions menu, press and hold the + and - buttons simultaneously for 10 seconds. The screen will automatically go to the main screen and the thermostat will display a lock icon.

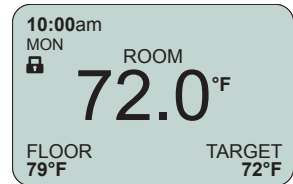

No settings will be able to be changed when the thermostat is locked. Only on the Thermolinx mobile app you will have the ability to still make changes.

Only minimal temperature target adjustment can be made. 2°C/3°F above/under.

Unlock Thermostat

In the special functions menu, press and hold the + and - buttons for 10 seconds. The screen will automatically go to the main screen and the lock icon will no longer appear.

1) Type - Select between Heating, Cooling, and a variety of combined modes.

SPECIAL FUNCTIONS

- ▶ 1) TYPE HEAT ONLY
- 2) VIEW ALL YES
- 3) VIEW AUTO YES
- 4) SETBACK YES
- 5) ROOM OFFSET 0°F
- 6) GEO MODE N

▶ **Heat Only Function**

Select the "Heat Only Function" for applications using a single heating source.

SPECIAL FUNCTIONS

- ▶ 1) TYPE COOL ONLY
- 2) VIEW ALL YES
- 3) VIEW AUTO YES
- 4) SETBACK YES
- 5) ROOM OFFSET 0°F
- 6) GEO MODE N

▶ **Cool Only Function**

Select the "Cool Only Function" for applications using a single cooling source.

SPECIAL FUNCTIONS

- ▶ 1) TYPE HEAT AND COOL
- 2) VIEW ALL YES
- 3) VIEW AUTO YES
- 4) SETBACK YES
- 5) ROOM OFFSET 0°F
- 6) GEO MODE N

▶ **Heat/Cool Function**

Select the "Heat/Cool Function" for applications using a single heating source and a single cooling source.

SPECIAL FUNCTIONS

- ▶ 1) TYPE 2 STAGE HEAT
- 2) VIEW ALL YES
- 3) VIEW AUTO YES
- 4) SETBACK YES
- 5) ROOM OFFSET 0°F
- 6) GEO MODE N

▶ **Heat/Heat Function**

Select the "Heat/Heat Function" for applications using 2 stage heating.

SPECIAL FUNCTIONS

- ▶ 1) TYPE 2 STAGE COOL
- 2) VIEW ALL YES
- 3) VIEW AUTO YES
- 4) SETBACK YES
- 5) ROOM OFFSET 0°F
- 6) GEO MODE N

▶ **Cool/Cool Function**

Select the "Cool/Cool Function" for applications using 2 stage cooling.

SPECIAL FUNCTIONS

- ▶ 1) TYPE 2 HEAT WITH COOL
- 2) VIEW ALL YES
- 3) VIEW AUTO YES
- 4) SETBACK YES
- 5) ROOM OFFSET 0°F
- 6) GEO MODE N

▶ **2 Heat/Cool Function**

Select the "2 Heat/Cool Function" for applications using 2 stage heating and 1 stage cooling.

SPECIAL FUNCTIONS

- ▶ 1) TYPE 2 COOL WITH HEAT
- 2) VIEW ALL YES
- 3) VIEW AUTO YES
- 4) SETBACK YES
- 5) ROOM OFFSET 0°F
- 6) GEO MODE N

▶ **2 Cool/Heat Function**

Select the "2 Cool/Heat Function" for applications using 2 stage cooling and 1 stage heating.

SPECIAL FUNCTIONS

- ▶ 1) TYPE 2 HEAT AND 2 COOL
- 2) VIEW ALL YES
- 3) VIEW AUTO YES
- 4) SETBACK YES
- 5) ROOM OFFSET 0°F
- 6) GEO MODE Y

▶ **Geo Mode: 2 Heat & 2 Cool**

Select the "2 Heat and 2 Cool Function" for applications using 2 stage heating **and** 2 stage cooling.

This option is only available in Geo Mode.

SPECIAL FUNCTIONS

- 1) TYPE HEAT ONLY
- ▶ 2) VIEW ALL YES
- 3) VIEW AUTO YES
- 4) SETBACK YES
- 5) ROOM OFFSET 0°F
- 6) GEO MODE N

▶ **View All/Hide All**

Select "No" to turn off "Status Screen" information and provide a simplified information readout of the "Status Screen". This option turns off any extra sensor readings on the control.

"View All" = Yes

- LT = Low Temp
- HT = High Temp
- DHW= Domestic Hot Water
- FN = Fan
- FHT = Fancoil Heat
- FCL = Fancoil Cool
- CL = Cool
- HD = Heat Demand
- CD = Cold Demand

"View All" = No

SPECIAL FUNCTIONS

- 1) TYPE HEAT ONLY
- 2) VIEW ALL YES
- ▶ 3) VIEW AUTO YES
- 4) SETBACK YES
- 5) ROOM OFFSET 0°F
- 6) GEO MODE N

▶ **View Auto**

This feature allow you automatic changeover or manual changeover. Changeover refers to the thermostat being switched from heat to cool as the air crosses a certain temperature. Auto changeover switches from heat to cool automatically while manual changeover thermostats must be changed by hand. If you select "NO", changeover is not going to appear in the Adjustment screen.



Applicable to: Heat/Cool, 2Heat/Cool, 2Cool/Heat and 2Heat/2Cool modes.

SPECIAL FUNCTIONS

- 1) TYPE HEAT ONLY
- 2) VIEW ALL YES
- 3) VIEW AUTO YES
- ▶ 4) SETBACK YES
- 5) ROOM OFFSET 0°F
- 6) GEO MODE N

▶ **Setback**

Allows you to program a setback. A setback can be programmed to maximize energy during time frames where the zone may be vacant. When you select "YES" you can program up to 4 setback time period.

SPECIAL FUNCTIONS

- 1) TYPE HEAT ONLY
- 2) VIEW ALL YES
- 3) VIEW AUTO YES
- 4) SETBACK YES
- ▶ 5) ROOM OFFSET 0°F
- 6) GEO MODE N

▶ Offset

This feature allows you to program an offset. In the case that the thermostat is not reading the same temperature as the actual temperature in the room. This setting allows the user to offset the temperature showing on the thermostat.

eg. Actual Room Temperature 72 °F

Direct Sunlight causes Thermostat to show 73 °F

The user can put an offset of -1 °F to get the temperatures to match.

SPECIAL FUNCTIONS

- 1) TYPE HEAT ONLY
- 2) VIEW ALL YES
- 3) VIEW AUTO YES
- 4) SETBACK YES
- 5) ROOM OFFSET 0°F
- ▶ 6) GEO MODE N

▶ Geo Mode

This feature allows you to control 2 or 4 pipe systems for geothermal applications. This allows for 2 stage heating and cool functions. This setting will change the demand outputs on the ZON-0550 from a low and high temperature to a heat and cool demand.

This mode can only be turned on/off using the first THM-0500 thermostat connected to the ZON-0550 controller.

Default: 2 pipe system. To change to a 4 pipe system, go to zone setup options (page 8).

THE SETUP MENU SCREEN

Holding down the **set** button for 2 seconds while viewing the “**Status Screen**” will take you into the “**System Setup Screen**” for the respective thermostat modes.



Once you are in the desired options screen, use the **+** and **-** button to scroll up and down. Press down the **set** button to choose the option (the arrow to the left of your chosen option will turn black when you have selected a specific step), then the **+** and **-** buttons to adjust the value.

SETUP MENU	
▶ 1) SCHEDULE	
2) MODE	
3) SYSTEM SETUP	
4) TIME	

▶ Setback Schedule

Up/down arrows on the upper left hand corner of the display signify additional screen options either above or below the scroll menu.

WEEKDAY PROGRAMS		
	START	HEAT
▶ 1)	6:00A	74°F
2)	8:00A	64°F
3)	4:30P	72°F
4)	9:00P	90°F
5)	BACK	

▶ Weekday Programs

Adjust four time periods within the five weekday program menu. The “Back” option allows the user to return to the previous screen.

WEEKEND PROGRAMS		
	START	HEAT
▶ 1)	9:00A	74°F
2)	9:00A	74°F
3)	9:00P	64°F
4)	9:00P	64°F
5)	BACK	

▶ Weekend Programs

Adjust four time periods within the two weekend program menu. The “Back” option allows the user to return to the previous screen.

WEEKEND PROGRAMS			
	START	HEAT	COOL
▶ 1)	9:00A	74°F	79°F
2)	9:00A	74°F	79°F
3)	9:00P	64°F	69°F
4)	9:00P	64°F	69°F
5)	BACK		

▶ Cooling Programs

A cooling setpoint is available when the thermostat has been chosen to have any cooling function.



There must be a minimum of 2°F differential between hot and cold settings.

SCHEDULE	
1) WEEKDAY	
2) WEEKEND	
▶ 3) AWAY TEMP	37°F
4) SET AWAY	OFF

▶ Away Temperature

Set the temperature for when the zone is in Away Mode



Away Mode can only be set on the thermostat if setbacks are enabled.

SCHEDULE	
1) WEEKDAY	
2) WEEKEND	
3) AWAY TEMP	37°F
▶ 4) SET AWAY	OFF

▶ Set Away

Set the zone to Away Mode

SETUP MENU

- ▶ 1) TARGET TEMP **78°F**
- 2) MODE
- 3) SYSTEM SETUP
- 4) TIME

▶ Target Temperature

When Setbacks are set to **OFF**, use this to change the minimum/maximum temperature for your zone depending on if your zone is set up for heating or cooling. If the temperature in the zone falls below/ rises above this temperature, heating or cooling will come on.

SETUP MENU

- ▶ 1) HEATING TEMP **70°F**
- 2) COOLING TEMP **75°F**
- 3) CHANGEOVER AUTO
- 4) MODE
- 5) SYSTEM SETUP
- 6) TIME

▶ Heating Temperature

Change the minimum temperature for your zone. If the temperature in the zone falls below this temperature, heating will come on.

SETUP MENU

- 1) HEATING TEMP **70°F**
- ▶ 2) COOLING TEMP **75°F**
- 3) CHANGEOVER AUTO
- 4) MODE
- 5) SYSTEM SETUP
- 6) TIME

▶ Cooling Temperature

Change the maximum temperature for your zone. If the temperature in the zone increases above this temperature, cooling will come on.

SETUP MENU

- 1) HEATING TEMP **70°F**
- 2) COOLING TEMP **75°F**
- ▶ 3) CHANGEOVER AUTO
- 4) MODE
- 5) SYSTEM SETUP
- 6) TIME

▶ Changeover

Auto: this option allows you to change automatically from heat mode to cool mode or vice versa
Heat: Allows the user to be only in heat mode
Cool: Allows the user to be only in cool mode



This option is only available when you select "YES" in View Auto options in the Special Functions screen.



Applicable to: Heat/Cool, 2Heat/Cool, 2Cool/Heat and 2Heat/2Cool modes.

MODE OPTIONS

This option allows you to select between Room, Floor and Dual sensor modes. If you are setting your Thermostat as a **DHW Zone**, see **Zone Demand** on page 9. Selecting **DHW** will automatically configure your sensor.



If you are using an external room thermistor, see page 13 for thermistor switch settings.

SETUP MENU

- 1) SCHEDULE
- ▶ 2) MODE
- 3) SYSTEM SETUP
- 4) TIME

▶ Mode Setup

This setting takes you to the Mode Setup menu, and allows you to select the thermostat mode.

THERMOSTAT OFF

MODE SETUP

- ▶ 1) THERMOSTAT ON
- 2) ZONE VALVE OFF
- 3) MODE ROOM
- 4) SENSOR 1 FLOOR

▶ Thermostat Off

When set to OFF, the thermostat will disable the ability to make a heating or cooling demand. All other features will still be available.

MODE SETUP

- 1) THERMOSTAT ON
- ▶ 2) ZONE VALVE OFF
- 3) MODE ROOM
- 4) SENSOR 1 FLOOR

▶ Zone Valve

When set to ON, The zone will be utilizing a zone valve or actuator. There will be a 60 second delay for the system pump to turn on when there is a heat or cool demand.

ROOM MODE OPTION

MODE SETUP

- 1) THERMOSTAT ON
- 2) ZONE VALVE OFF
- ▶ 3) MODE ROOM
- 4) SENSOR 1 FLOOR

▶ Room Mode

Sensor temperature providing feedback for the specific room or zone being controlled by the thermostat.

MODE SETUP

- 1) THERMOSTAT ON
- 2) ZONE VALVE OFF
- 3) MODE ROOM
- ▶ 4) SENSOR 1 FLOOR

▶ Room Mode: Sensor 1

None – No external thermistor attached.

RM/Ave – averages external 1 and internal sensor, or optional external room sensor (see page 13 for instructions).

Outdoor – Uses external sensor to display outdoor temperature.

Room - disregards internal sensor, uses external 1.

Floor – displays the floor temperature using external 1 sensor.

DUAL MODE OPTION

MODE SETUP

- 1) THERMOSTAT ON
- 2) ZONE VALVE OFF
- ▶ 3) MODE DUAL
- 4) FLOOR MAX 80°F
- 5) FLOOR MIN 70°F
- 6) SENSOR 1 FLOOR

▶ Dual Mode

Sensor temperature providing feedback for both the air temperature and floor sensor temperatures.



Only available when heating modes are the primary function.

MODE SETUP

- 1) THERMOSTAT ON
- 2) ZONE VALVE OFF
- 3) MODE DUAL
- ▶ 4) FLOOR MAX 80°F
- 5) FLOOR MIN 70°F
- 6) SENSOR 1 FLOOR

▶ Dual Mode: Floor Maximum

The thermostat will not allow the temperature in the floor to go above this value, protecting the integrity of the floor covering.

MODE SETUP

- 1) THERMOSTAT ON
- 2) ZONE VALVE OFF
- 3) MODE DUAL
- 4) FLOOR MAX **80°F**
- ▶ 5) FLOOR MIN **70°F**
- 6) SENSOR 1 FLOOR

▶ Dual Mode: Floor Minimum

The thermostat will not allow the temperature in the floor to go below this value, protecting the integrity of the floor covering. If in a 2 stage heating mode, only the radiant heating contact is turned off.

MODE SETUP

- 1) THERMOSTAT ON
- 2) ZONE VALVE OFF
- 3) MODE DUAL
- 4) FLOOR MAX **80°F**
- 5) FLOOR MIN **70°F**
- ▶ 6) SENSOR 1 FLOOR

▶ Dual Mode: Sensor 1

This option will be automatically set to floor sensor.

FLOOR MODE OPTION

MODE SETUP

- 1) THERMOSTAT ON
- 2) ZONE VALVE OFF
- ▶ 3) MODE FLOOR
- 4) DIFF **5°F**
- 5) SENSOR 1 FLOOR

▶ Floor Mode

Sensor temperature providing feedback from the floor surface to the thermostat. This mode will run the thermostat on floor temperature only.



Only available when heating modes are the primary function.

MODE SETUP

- 1) THERMOSTAT ON
- 2) ZONE VALVE OFF
- 3) MODE FLOOR
- ▶ 4) DIFF **5°F**
- 5) SENSOR 1 FLOOR

▶ Floor Mode: Differential

When in floor mode, the differential option is set to allow a differential around the target to lesson the chances of short cycling.

MODE SETUP

- 1) THERMOSTAT ON
- 2) ZONE VALVE OFF
- 3) MODE FLOOR
- 4) DIFF **5°F**
- ▶ 5) SENSOR 1 FLOOR

▶ Floor Mode: Sensor 1

This option will be automatically set to floor sensor.

SYSTEM SETUP OPTIONS

This selection allows you to access the System Setup menu.

SETUP MENU

- 1) SCHEDULE
- 2) MODE
- ▶ 3) SYSTEM SETUP
- 4) TIME

▶ System Setup

This setting takes you to the System Setup Menu.

ZONE SETUP OPTIONS

SYSTEM SETUP

- ▶ 1) ZONE SETUP
- 2) FANCOIL SETUP
- 3) °C OR °F °F
- 4) STAGE DELAY **15m**

▶ Zone Setup

This setting takes you to the Zone Setup Menu.

SYNC CODE: ABCD-1234

ZONE SETUP

- ▶ 1) SEQUENCE 1 - 4
- 2) DEMAND LOW
- 3) PRIORITY NONE
- 4) PASSWORD AB12
- 5) MASTER ID:A2
- 6) DAMPER ZONE OFF

ZONE SETUP

- 1) SEQUENCE 1 - 4
- ▶ 2) DEMAND LOW
- 3) PRIORITY NONE
- 4) PASSWORD AB12
- 5) MASTER ID:A2
- 6) DAMPER ZONE OFF

ZONE SETUP

- 1) SEQUENCE 1 - 4
- 2) DEMAND LOW
- ▶ 3) PRIORITY NONE
- 4) PASSWORD AB12
- 5) MASTER ID:A2
- 6) DAMPER ZONE OFF

ZONE SETUP

- 1) SEQUENCE 1 - 4
- 2) DEMAND LOW
- 3) PRIORITY NONE
- ▶ 4) PASSWORD AB12
- 5) MASTER ID:A2
- 6) DAMPER ZONE OFF

ZONE SETUP

- 1) SEQUENCE 1 - 4
- 2) DEMAND LOW
- 3) PRIORITY NONE
- 4) PASSWORD AB12
- ▶ 5) MASTER ID:A2
- 6) DAMPER ZONE OFF

▶ Zone Setup: Sequence

This option allows the user to set the zone module sequence order. Select the sequence you would like to set up for the module (1-4, 5-8, 9-12,13-16, 17-20). Adjusting the sequence order can only be done using the first THM-0300 (zone 1) thermostat that is connected to the zone module.



Selecting sequence order (1-4) will set the zone module as the “master”.

▶ Zone Setup: Demand

This option allows the user to determine what happens when the thermostat makes a call.

Low - Low Temperature Demand

High - High Temperature Demand

DHW - Domestic Hot Water (Digital Aquastat)

Fan - Fancoil Demand

▶ Zone Setup: Priority

This option allows the user to set a priority on a zone(s) over other zone(s). Priorities range from 1 (highest) to 7 (lowest). Higher priorities will lock out lower priorities until the demand has been satisfied. Multiple zones can be given the same numbered priority. The Priority Shield option allows a zone to ignore other priorities from other zones.



Priority 1 is a timed priority of 60 minutes, generally used for DHW.

▶ Zone Setup: Password

This option allows the user to see or change the password to connect to the Zoning App.

▶ Zone Setup: Master ID

With this option, if the thermostat is connected to the first zone module it will display the master ID. If selected it will put the module into “Discovery mode”. If the thermostat is connected to additional zone modules, it will indicate the ID of the master module it is paired to. If selected it will put the module into pairing mode.

ZONE SETUP

- 1) SEQUENCE 1 - 4
- 2) DEMAND LOW
- 3) PRIORITY NONE
- 4) PASSWORD AB12
- 5) MASTER ID:A2
- ▶ 6) DAMPER ZONE OFF

▶ Zone Setup: Damper Zone

This option allows you to set the zone as a damper zone.

Off: No damper being utilized in current setup.

Single N/O: Corresponding zone output is utilizing normally open dampers.

Single N/C: corresponding zone output is utilizing normally closed dampers.

2 Stage N/O: 1st stage is radiant and the second stage is utilizing a normally open damper.

Utilizing this option will require to use the next corresponding zone output to accommodate for the second stage damper. This option is only available for Zones 1 and Zone 3.

2 Stage N/C: 1st stage is radiant and the second stage is utilizing a normally closed damper.

Utilizing this option will require to use the next corresponding zone output to accommodate for the second stage damper. This option is only available for Zone 1 and Zone 3.

ZONE SETUP

- 1) SEQUENCE 1 - 4
- 2) DEMAND LOW
- 3) PRIORITY NONE
- 4) PASSWORD AB12
- 5) MASTER ID:A2
- ▶ 6) 4 PIPE ZONE NO

▶ Zone Setup: 4 Pipe Zone

This option allows you to control a 4 pipe system in a geothermal application.

Default: No

FANCOIL SETUP OPTIONS

SYSTEM SETUP

- 1) ZONE SETUP
- ▶ 2) FANCOIL SETUP
- 3) °C OR °F °F
- 4) STAGE DELAY 15m

SYNC CODE: ABCD-1234

▶ Fancoil Setup

This setting takes you to the Fancoil Setup Menu.

FANCOIL SETUP

- ▶ 1) FAN ON DMD NO
- 2) ZONE ON DMD NO
- 3) TEMP AVE NONE
- 4) FAN MODE OFF

▶ Fancoil Setup: Fan On Demand

This option will turn the fan on with any fancoil demand

FANCOIL SETUP

- 1) FAN ON DMD NO
- ▶ 2) ZONE ON DMD NO
- 3) TEMP AVE NONE
- 4) FAN MODE OFF

▶ Fancoil Setup: Zone On Demand

This option will turn the zone pump on with any fancoil demand

FANCOIL SETUP

- 1) FAN ON DMD NO
- 2) ZONE ON DMD NO
- ▶ 3) TEMP AVE NONE
- 4) FAN MODE OFF

► Fancoil Setup: Temperature Averaging

This option will average the temperature between thermostats (User Selectable), when that average falls below or above the setpoint, depending on if it's in heating or cooling, then the thermostat will make a call for heating or cooling on the fancoil.

FANCOIL SETUP

- 1) FAN ON DMD NO
- 2) ZONE ON DMD NO
- 3) TEMP AVE NONE
- ▶ 4) FAN MODE OFF

► Fancoil Setup: Fan Mode

OFF: Indicated Fan is off

ON: Enables the fan to run constantly, regardless of whether the thermostat is calling for heating or cooling

INT: This setting will set the ON/OFF time for the intermittent fan

*Ex: The fan will come on for **15 min** every **2H**. Set (Int Fan On: **15 min**) & (Int Fan Off: **2H**)*

FANCOIL SETUP

- 1) FAN ON DMD NO
- 2) ZONE ON DMD NO
- 3) TEMP AVE NONE
- 4) FAN MODE INT
- ▶ 5) INT FAN ON 2m
- 6) INT FAN OFF 1H

► Fan Mode INT: Intermittent Fan On

Sets the amount of time the fan will operate. Only applicable when Fan Mode is set to **INT**.

FANCOIL SETUP

- 1) FAN ON DMD NO
- 2) ZONE ON DMD NO
- 3) TEMP AVE NONE
- 4) FAN MODE INT
- 5) INT FAN ON 2m
- ▶ 6) INT FAN OFF 1H

► Fan Mode INT: Intermittent Fan Off

Sets the amount of time that must pass before the fan can come on again. Only applicable when Fan Mode is set to **INT**.

CELSIUS OR FARENHEIT

SYSTEM SETUP

- 1) ZONE SETUP
- 2) FANCOIL SETUP
- ▶ 3) °C OR °F °F
- 4) STAGE DELAY 15m

SYNC CODE: ABCD-1234

► Celsius or Farenheit

This option will change the thermostat temperature to either Celsius or Farenheit.

SYSTEM SETUP

- 1) ZONE SETUP
- 2) FANCOIL SETUP
- 3) °C OR °F °F
- ▶ 4) STAGE DELAY 15m

SYNC CODE: ABCD-1234

STAGE DELAY OPTION

► Stage Delay

Use this setting to adjust the lagtime between stage 1 and stage 2 coming on.

Default: 15m

Range: 1m - 240m



This option is only available in 2 stage applications.

SYNC CODE

SYSTEM SETUP

- 1) ZONE SETUP
- 2) FANCOIL SETUP
- 3) °C OR °F °F
- ▶ 4) STAGE DELAY **15m**

SYNC CODE: ABCD-1234

▶ Sync Code

This number is the identifier used in the HBX ThermoLinX App to connect to your thermostat.

TIME OPTIONS

This selection allows you to access the Time Setup menu.

SETUP MENU

- 1) SCHEDULE
- 2) MODE
- 3) SYSTEM SETUP
- ▶ 4) TIME

▶ Time Setup

This setting takes you to the Time Setup Menu.

TIME SETUP

- ▶ 1) TIME 1:00pm
- 2) DAY OF WEEK MON
- 3) TIME ZONE CENTRAL
- 4) AUTO TIME ON

▶ Time Setup: Time

Set the time for your appropriate time zone.

TIME SETUP

- 1) TIME 1:00pm
- ▶ 2) DAY OF WEEK MON
- 3) TIME ZONE CENTRAL
- 4) AUTO TIME ON

▶ Time Setup: Day of Week

Set the current day of the week.

TIME SETUP

- 1) TIME 1:00pm
- 2) DAY OF WEEK MON
- ▶ 3) TIME ZONE CENTRAL
- 4) AUTO TIME ON

▶ Time Setup: Time Zone

Set the appropriate time zone for your area.

TIME SETUP

- 1) TIME 1:00pm
- 2) DAY OF WEEK MON
- 3) TIME ZONE CENTRAL
- ▶ 4) AUTO TIME ON

▶ Time Setup: Auto Time

Use this setting to allow the network to automatically update your time when WiFi is enabled on your system.

INSTALLATION AND WIRING

MOUNTING INSTRUCTIONS

In order to assure proper room temperature, it is important to identify the ideal location of the thermostat. It should be approximately 5 feet from the floor and at least 1 foot from door openings on an interior wall. Avoid exposing the thermostat to direct sunlight, to air flows (doors, windows, etc.) as well as to heat sources.

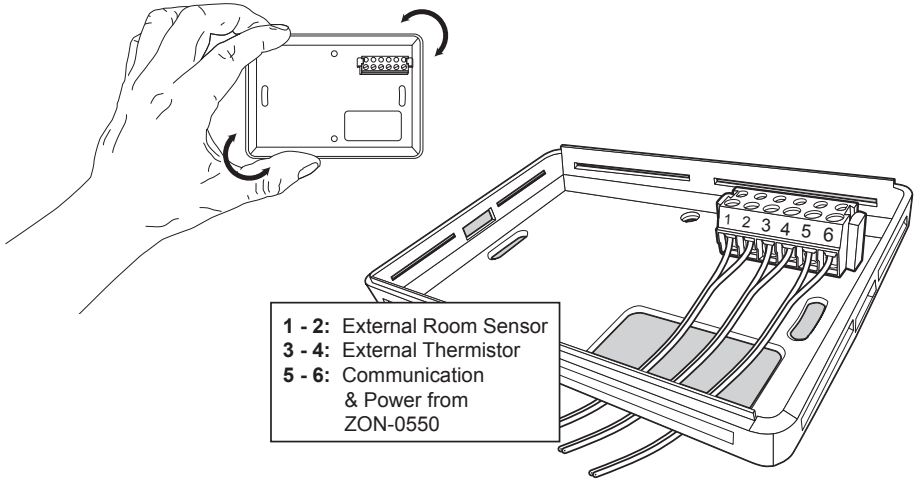

EXTERNAL ROOM THERMISTOR

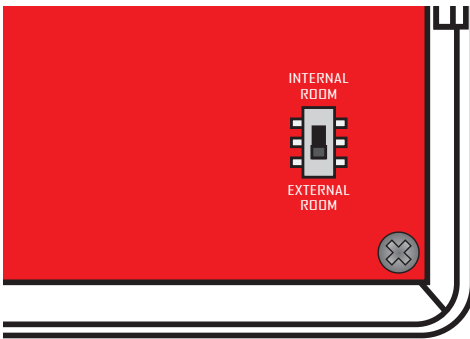

On the THM-0300, the room thermistor switch is located on the bottom right corner of the thermostat.

toggling this switch will allow the user to alternate between the built in room thermistor on the THM-0300, or an external room thermistor connected to pins 1 and 2 on the THM-0300.

WIRING EXAMPLES

THM-0300 using Internal Sensor

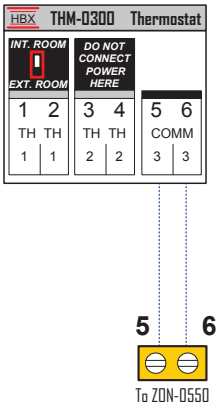

THM-0300 using DHW Sensor as a Digital Aquastat

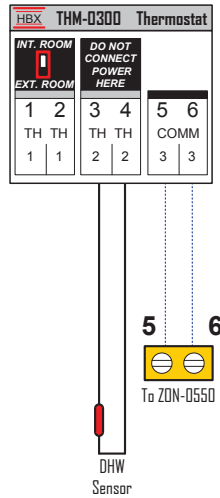

THM-0300 using Room Sensor

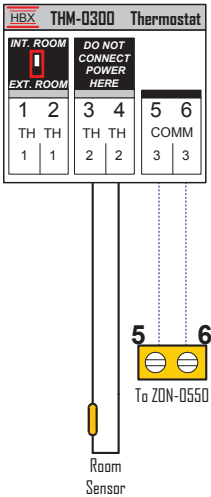

THM-0300 Room averaging using 2 External Room Sensors

To use external room thermistor, toggle dispswitch from Internal to External on THM-0300

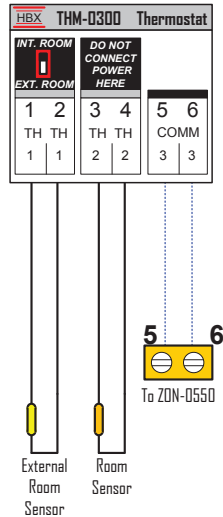

*Sensor input can be used for DHW, Room, Floor, and Outdoor Sensors

THM-0300 using Floor Sensor

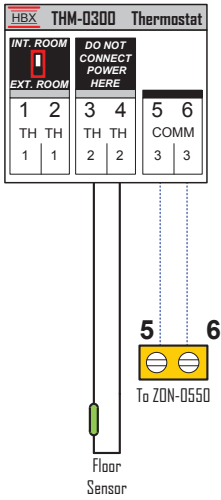

THM-0300 using Outdoor Sensor

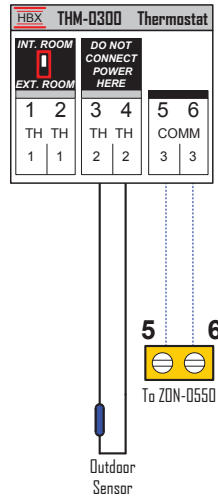

THM-0300 Dual Mode using External Room Sensor and Floor Sensor

To use external room thermistor, toggle disswitch from Internal to External on THM-0300

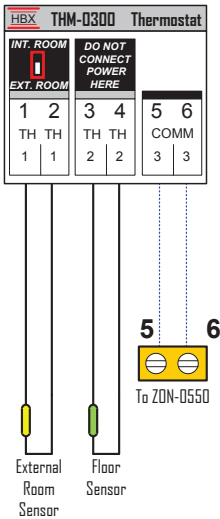

TROUBLESHOOTING GUIDE

ISSUE	POSSIBLE CAUSES & RESOLUTIONS
Blank Screen	<ul style="list-style-type: none">• <i>Check the ZON-0550 power</i>• <i>Check wiring polarity between the THM-0300/THM-0500 and ZON-0550 module.</i>• <i>Ensure zones 1 and 3 damper/4-pipe is set correctly.</i>
Stage 2 won't come on	<ul style="list-style-type: none">• <i>Check stage delay in system setup for proper time.</i>• <i>In special functions ensure you have selected correct thermostat type.</i>
Demand not coming on	<ul style="list-style-type: none">• <i>Demands may take up to 5 minutes to operate due to P.I.D algorithm.</i>• <i>Verify wiring on the ZON-0550 module.</i>• <i>Check priorities settings in zone setup.</i>• <i>Check the changeover settings</i>
Temperature not displaying correct value	<ul style="list-style-type: none">• <i>If it is showing dash lines ensure that the proper thermostat mode is selected in mode setup.</i>• <i>Ensure external sensor(s) is wired correctly.</i>• <i>Make sure the external room dipswitch on the board is in the correct position.</i>
Target changing	<ul style="list-style-type: none">• <i>Check the setback schedule</i>• <i>If you're in auto changeover, then the target can change to either heating target or cooling target based on actual room temperature.</i>

TROUBLESHOOTING GUIDE

ISSUE	POSSIBLE CAUSES & RESOLUTIONS
Thermostat(s) not showing up on ThermoLinx App	<ul style="list-style-type: none">• <i>Verify sync code and password on thermostat is correct when adding devices</i>• <i>Manually check in thermostat(s)</i>• <i>Ensure zone modules are paired</i>• <i>System is not connected to the internet</i>
Thermostat settings not displayed on the ThermoLinx App	<ul style="list-style-type: none">• <i>Contact HBX Technical support for contactor code to unlock advanced settings.</i>

For additional assistance with the THM-0500, please contact our Technical Support Department toll free at:

+1 (855) 410-2341

LIMITED WARRANTY

HBX Controls warrants each of its products to be free from defects in workmanship and materials under normal use and service for a period of 24 months from date of manufacture or 12 months from date of purchase from an HBX Authorized Dealer, if within the above documented period after date of manufacture.

If the product proves to be defective within the applicable warranty period, HBX on its sole discretion will repair or replace said product. Replacement product may be new or refurbished of equivalent or better specifications, relative to the defective product. Replacement product need not be of identical design or model. Any repair or replacement product pursuant to this warranty shall be warranted for not less than 90 days from date of such repair, irrespective of any earlier expiration of original warranty period. When HBX provides replacement, the defective product becomes the property of HBX Controls.

Warranty Service, within the applicable warranty period, may be obtained by contacting your nearest HBX Controls office via the original Authorized Agent and requesting a Return Material Authorization Number (RMA #). Proof of purchase in the form a dated invoice/receipt must be provided to expedite the issuance of a Factory RMA.

After an RMA number has been issued, the defective product must be packaged securely in the original or other suitable shipping package to ensure that it will not be damaged in transit. The RMA number must be visible on the outside of the package and a copy included inside the package. The package must be mailed or otherwise shipped back to HBX with all costs of mailing/shipping/insurance prepaid by the warranty claimant.

Any package/s returned to HBX without an approved and visible RMA number will be rejected and shipped back to purchaser at purchaser's expense. HBX reserves the right, if deemed necessary, to charge a reasonable levy for costs incurred, additional to mailing or shipping costs.

LIMITATION OF WARRANTIES

If the HBX product does not operate as warranted above the purchasers sole remedy shall be, at HBX's option, repair or replacement. The foregoing warranties and remedies are exclusive and in lieu of all other warranties, expressed or implied, either in fact or by operation of law, statutory or otherwise, including warranties of merchantability and fitness for a particular purpose/application. HBX neither assumes nor authorizes any other person to assume for it any other liability in connection with the sale, installation maintenance or use of HBX Controls products.

HBX shall not be liable under this warranty; if its testing and examination discloses that the alleged defect in the product does not exist or was caused by the purchasers or third persons misuse, neglect, improper installation or testing, unauthorized attempts to repair or any other cause beyond the range of intended use, or by accident, fire, lightning or other hazard.

LIMITATION OF LIABILITY

In no event will HBX be liable for any damages, including loss of data, loss of profits, costs of cover or other incidental, consequential or indirect damages arising out of the installation, maintenance, commissioning, performance, failure or interruption of an HBX product, however caused and on any theory of liability. This limitation will apply even if HBX has been advised of the possibility of such damage.

LOCAL LAW

This limited warranty statement gives the purchaser specific legal rights. The purchaser may also have other rights which vary from state to state in the United States, from Province to Province in Canada and from Country to Country elsewhere in the world.

To the extent this Limited Warranty Statement is inconsistent with local law, this statement shall be deemed modified to be consistent with such local law. Under such local law, certain disclaimers and limitations of this statement may not apply to the purchaser. For example, some states in the United States, as well as some governments outside the United States (including Canadian Provinces), may: Preclude the disclaimers and limitations in this statement from limiting the statutory rights of a consumer (e.g. United Kingdom);

Otherwise restrict the ability of a manufacturer to enforce such disclaimers or limitations; or grant the purchaser additional warranty rights which the manufacturer cannot disclaim, or not allow limitations on the duration of implied warranties.

NOTES

Phone: +1 (403) 720-0029 Fax: +1 (403) 720-0054
Email: info@hbxcontrols.com Web: www.hbxcontrols.com

Toll Free Technical Support: +1 (855) 554 6629

