

NEXT GEN

MANUFACTURED BY KOSPEL BOILERS

Installation and Service Manual

Congratulations! You have purchased the most innovative electric boiler on the market. The NextGen Boiler™ will provide comfort and efficiency for your heating applications for many years to come.



NextGen Boiler
USA Distributor/Importer
550 Albion Ave
Schaumburg IL 60193
Phone: 844-227-9977
www.nextgenboiler.com



TABLE OF CONTENTS

Instructions for the installer

<i>Safety Instructions</i>	3
<i>NextGen Boiler Ratings and Specifications</i>	4
<i>Piping Arrangement</i>	6
<i>Sizing of the NextGen Boiler</i>	7
<i>Designed Temperature Differential</i>	7
<i>Circulating Pump Information</i>	7
<i>Plumbing Installation Guidelines</i>	8
<i>Electrical Installation</i>	9

Instructions for the user

<i>Control Panel</i>	11
<i>Heating Mode / Initial Start-Up</i>	11
<i>Winter Mode (Heating Mode)</i>	12
<i>Summer Mode (Stand-by Mode)</i>	13
<i>Advanced Settings</i>	14
<i>Troubleshooting</i>	15
<i>Care and Maintenance</i>	15
<i>General Boiler View</i>	16
<i>Part List</i>	17
<i>Warranty Information</i>	19
<i>Warranty Registration</i>	21

This appliance is not intended for use by persons (including children) with reduced physical, sensory or mental capabilities or lack of experience and knowledge, unless they have been given supervision or instruction concerning use of the appliance by a person responsible for their safety. Children should be supervised to ensure that they do not play with the boiler appliance.

Consider all piping and electrical connections before selecting boiler location.

Failure to follow the instructions in this manual could result in severe personal injury, death or property damage.



Safety Instructions

1. Read and strictly follow the installation and operating instructions to ensure a longevity and reliable boiler operation.
2. This manual provides general installation guidelines. Your installation must comply with ALL applicable local codes.
3. **⚠ Always** have a qualified electrician perform electrical wiring. Manufacturer will not be held responsible for faulty installations which are performed by unqualified electricians. An efficient electrical installation which has been completed in accordance with the binding norms of electric installation. Electric installation should be equipped with electric circuit breakers and other solutions which will ensure disconnecting the boiler from the source of power.
4. All installation work must be performed when the power and water supply is disconnected from the main electrical panel.
5. This boiler must be installed vertically and on an even wall surface with access to plumbing connections on bottom.
6. Any associated components (i.e. boiler, water tubing, valves, manifolds etc...) must be flushed before boiler installation.
7. This boiler is equipped with a safety relief valve. Do not install any barrier fitting or valve on the outlet of the safety valve. Connect and extend $\frac{3}{4}$ " copper piping from relief valve and terminate at least 6" from the floor or floor drain.
8. This boiler is equipped with a 194°F manual reset safety high limit device. The reset button is clearly located in the center of this device.
9. This boiler will not operate below a 7 psi water pressure level.
10. This boiler is equipped with a Wilo circulator pump. After thermostat temperature set point has been reached the pump will continue to circulate water for 3 additional minutes as part of a post purge sequence to push heated water away from heat exchanger.
11. This boiler is equipped with a differential pressure relief bypass valve. It allows the system to keep minimal flow of heating water through the boiler and reduce noise in the installation when equipped with thermostatic zone valves.
12. Do not drain the water from the boiler after the heating season.
13. In summer do not shut off the power supply (120 VAC and 240 VAC) and leave the controller in stand-by (summer mode) between the heating seasons. The boiler is equipped with an exercise timer control feature that allows the circulating pump to operate 15 minutes each day and will ensure longer operation the circulating pump and will help to eliminate the buildup of debris. (See section "Summer mode (stand-by mode)" on page 11).
14. Boiler is pre-set by the manufacturer to work with hydronic radiant floor, radiant ceiling, hot water baseboard and water to air heat applications. Temperature adjustments can be made on control panel to meet these applications requiring desired water temperatures between 85° - 140°F.

NextGen Boiler Ratings and Specifications

Boiler Name		NextGen-4	NextGen-6	NextGen-8	NextGen-12	NextGen-14.4
Boiler Type		EKCO-4	EKCO-6	EKCO-8	EKCO-12	EKCO-14.4
Boiler Rated Power	kW	4	6	8	12	14.4
	Btu/h	13,652	20,478	27,304	40,956	49,147
Voltage	V	240				
Rated Current	A	16.66	25.0	33.3	50.0	60.0
Breaker Quantity- Amps	A	1 @ 30 amp	1 @ 40 amp	1 @ 50 amp	1 @ 60/70 amp	1 @ 80 amp
Heating Elements	Quantity	3				
Element Resistance / each	Ω	43.3	28.8	21.6	14.4	12.0

Circulating Pump - Wilo Star S 21 U 15. 3 speed

Circulating Pump Voltage	V	120V, 60Hz				
Circulating Pump Amps	A	.97				
Speeds		3				
Fuse Rating		2.0 amp				

Operating Temperature Range	°F	85° - 140°				
Inlet / Outlet Pipe Thread		G ¾" (Internal Thread)				
Expansion Vessel (14 psi.)	Gallon	1.6				
Safety Relief Valve Rating	psi	30				
Maximum Pressure	psi	30				
Minimum Pressure	psi	7				
Weight	Lbs.	68.5				
Dimensions L x W x D	Inches	28" x 17" x 9 - 7/8"				
Minimum Flow Rate	gpm	1.1	1.32			

Disposable/Available Pump Head

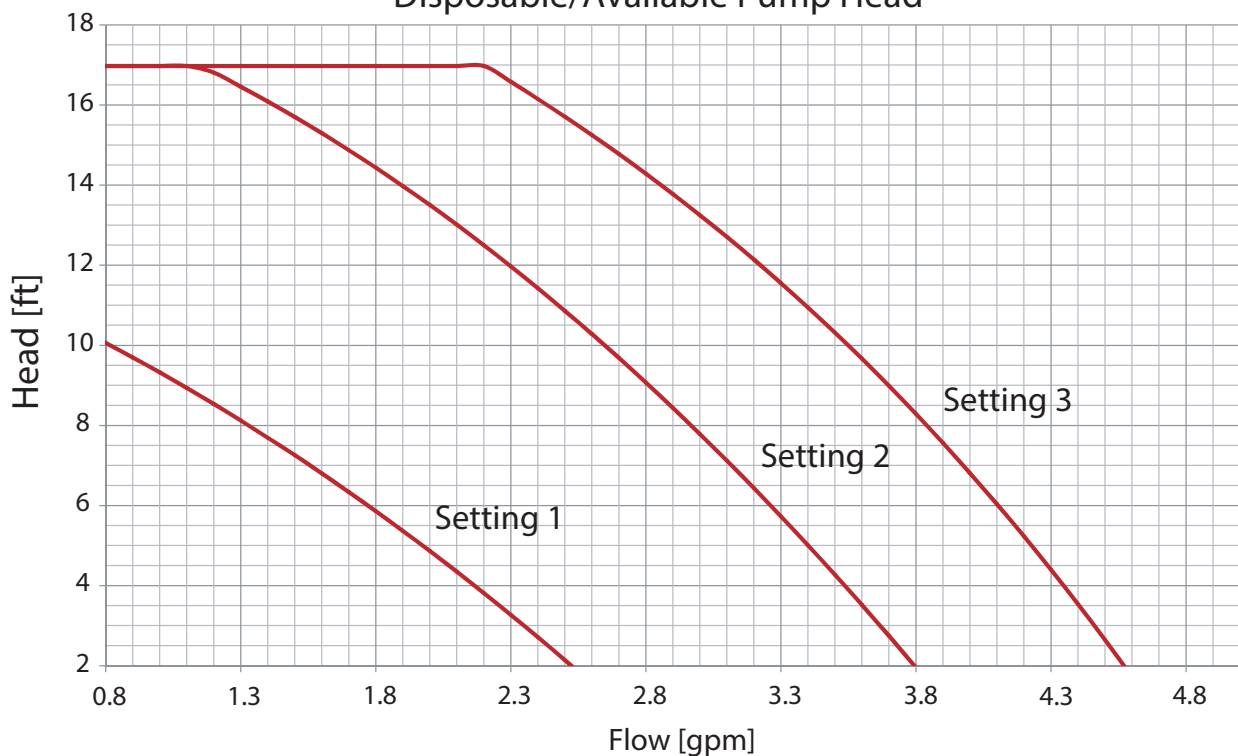

Instructions for the installer

NextGen Boiler Mounting Clearances

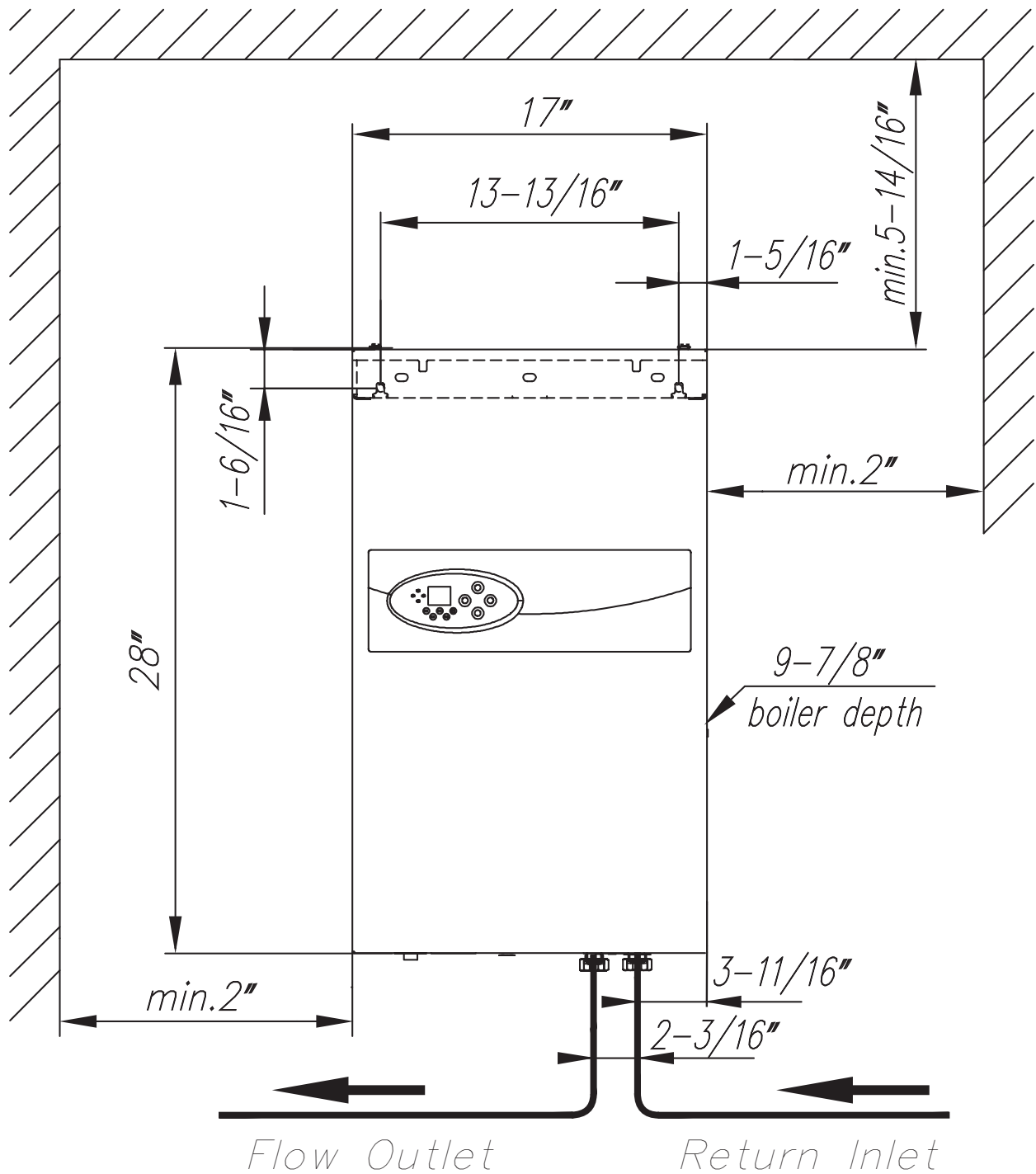

ATTENTION INSTALLER

⚠ After reading instructions, please keep this manual with the boiler for future reference. Affix the plastic holder to the outside of the boiler and insert manual in this pocket.

Piping Arrangement

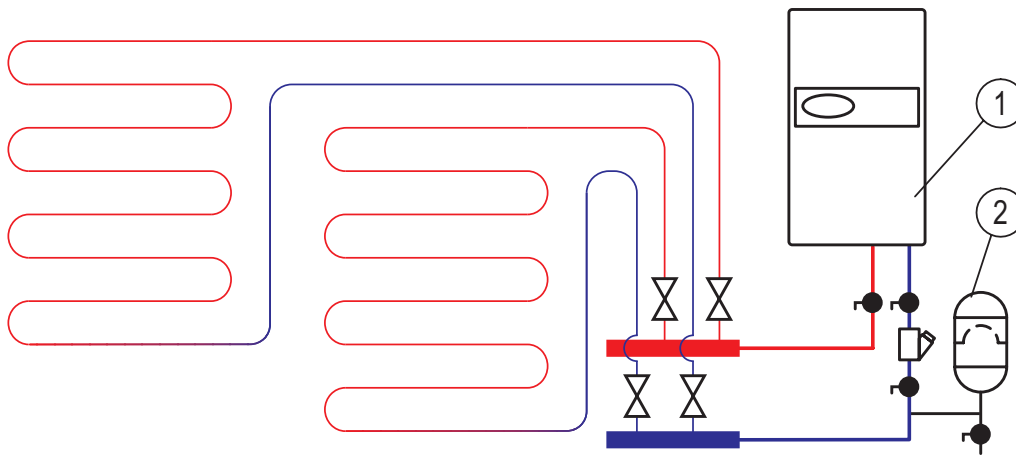

Typical radiant floor heating application

- [1] - boiler
- [2] - additional expansion tank - if needed

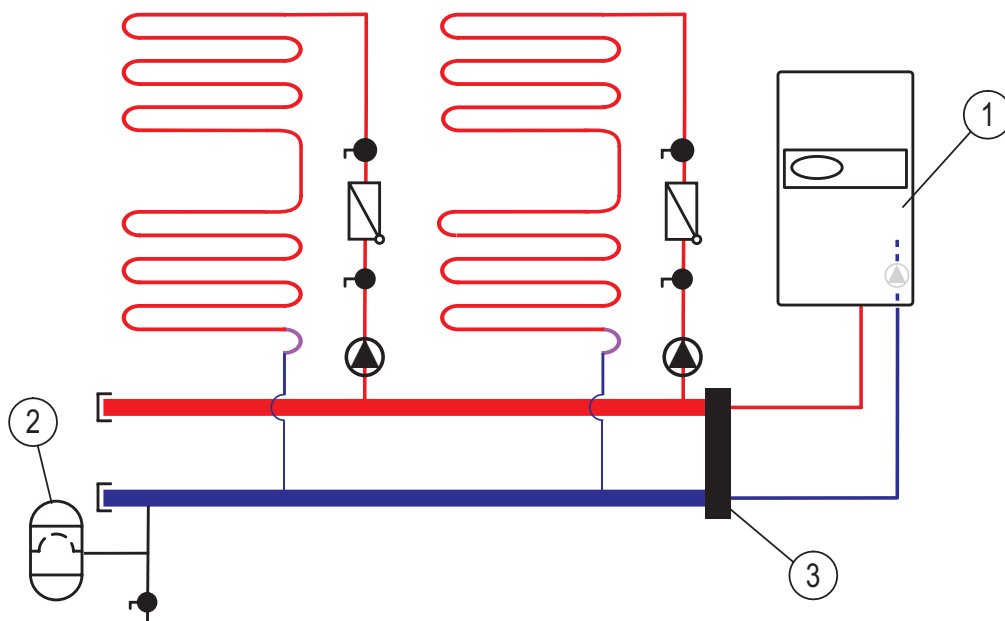

NextGen Boiler piped in a primary/secondary (P/S) configuration. Consider P/S when higher flow rates are necessary and when the boiler meets the intended heatloss of the hydronic system.

- [1] - boiler
- [2] - additional expansion tank - if needed
- [3] - low loss header

Sizing of the NextGen Boiler

It is very important to conduct a heatloss analysis of the intended heated space. Select the boiler size in kW based on its Btu/hr. rating that best meets the designed heatloss. It is important not to overly exceed the kW sizing as this will lead to unnecessary costs of boiler, wiring and materials. Consequentially it is extremely imperative NOT to undersize the boiler.

How to choose the correct boiler size? Convert BTU to kW by dividing the BTU load by 3,413.

(Ex. $33,513 \text{ BTU} / 3,413 = 9.81\text{kW}$). Choose a boiler that slightly exceeds this kW requirement by no more than 20%.

For larger BTU loads consider cascading the boilers together and pipe the system in a parallel configuration as described in the piping arrangement section.

Note that utilizing propylene glycol freeze protection will reduce the heat transfer and cause the system to be less efficient. Under no circumstance should more than a 50/50 ratio of water to propylene glycol be used. Consult with radiant system designers for required freeze protection guidelines.

Designed Temperature Differential

Radiant floor heating systems are typically designed for a 10°- 20°F temperature differential determined by when the heating fluid leaves the boiler and where it enters the radiant heat source. i.e. radiant PEX/tubing.

Circulating Pump Information

This boiler is equipped with a Wilo Star S 21 U 15, 3 speed circulating pump. To determine the speed or setting of the pump, confirm with radiant design completed by others and or complete a pressure-loss calculation. Refer to calculations of loop lengths to determine proper speed.

The pump will automatically operate based on a thermostat call for heat. After the thermostat temperature set point has been reached, the pump will continue to circulate water for 3 additional minutes as part of a post purge operation to push heated water away from the heat exchanger.



This boiler is also equipped with an additional pump relay. This will aid the installer if there is any need to pipe the systems with a secondary circulating pump to overcome pressure drop due to piping or hydronic tubing design. This is commonly referred to as primary/secondary applications described in the piping arrangement section.

Plumbing Installation Guidelines

1. Remove outer screws at the bottom and at the top of boiler and carefully open the front cover.
2. The boiler is wall hung and must be installed in a vertical position where plumbing connections are located at the bottom. Utilize key holes slots to hang the boiler. Refer to diagram on clearances (page 5).
3. The boiler is provided with a 3/8" air vent located on top of the heat exchanger. It is designed to collect and remove air. Ensure plastic drain tubing remains in place and exits the boiler in the lower right corner.
4. The boiler is equipped with a pre-charged flat expansion tank located on the back housing of the boiler.

Expansion tank has a Shrader valve, which location is shown on the figure. This figure presents the bottom view of the boiler. Access to the valve is only from the bottom of the boiler. From there it can be connected any pressure gauge to check the pressure or pump to refill the air inside the tank.

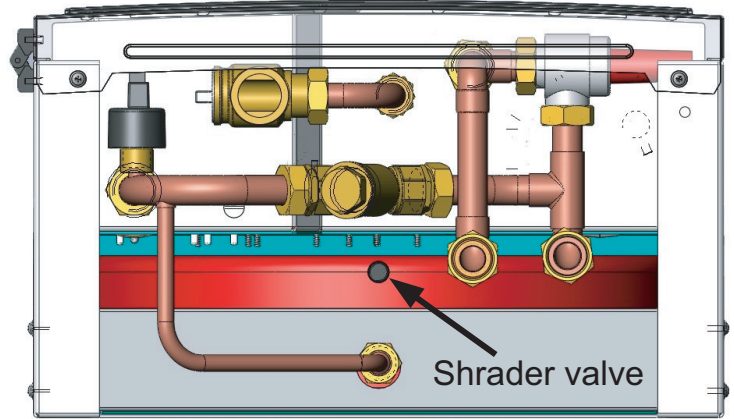

5. The boiler is equipped with an ASME approved 30 psi automatic safety pressure relief valve. Install the necessary length of 3/4" copper piping from the relief valve to within 6" of the floor to prevent personal injury or water damage to surrounding area.
6. Observe inlet return piping (blue) and outlet supply feed piping (red) connections. Install full way shut off valves below inlet and outlet connections before plumbing the boiler to the hydronic heating system. DO NOT reverse these connections to the radiant supply and return manifolds. Optional temperature or pressure gauges can be installed below the boiler if desired.
7. Install a boiler drain valve(s) as necessary to aid in filling, purging and draining of unit and the related system components.
8. Water supply feed or pressure reducing valve can be installed to comply with local building codes. Local codes may require a back flow preventer called a check valve when installing a fixed domestic water supply line to the boiler.
9. When possible, fill the boiler and hydronic system with treated water. (i.e. soft or distilled water) This will substantially extend the life of the heating elements and reduce sediment buildup.
10. Freeze protection additives can be added. Only use propylene glycol type freeze protection products for hydronic heating systems that are non-toxic and corrosion resistant.

The propylene glycol mix shall not exceed 50%, by volume. ⚠ Under no circumstance should methanol or ethylene glycol (automobile antifreeze) be added to the boiler system as this may damage internal components.

11. Insure purging of all air throughout boiler system and related components.
12. This boiler requires a minimum pressure of 7 psi in order to operate. Pressure levels for hydronic systems typically are above the pre-charged expansion tank pressure level (12 psi).

If additional pressure gauges are installed verify reading as described on item 7.

13. The boiler is equipped with a pressure differential bypass valve. This allows the minimum flow rate to pass through the boiler when all zone valves are closed. The valve will also help reduce noise issues upon closing of zone valves or actuators.

To adjust: Turn differential bypass valve clockwise until it stops. Turn on all heating zones and let them heat for a couple of minutes. Caution! piping can get hot quickly upon opening the valve. Slowly open the bypass valve by turning in a counter clock wise direction. Stop turning once an increase in temperature is felt on the outlet side of the valve. This is referred to the tipping point. After reaching the tipping point continue to turn the valve one complete turn. The valve is now set to bypass excess flow as zone valves close. Set the thermostats to normal set temperatures.



14. Proceed to the Electrical Installation.

Electrical Wiring Diagram

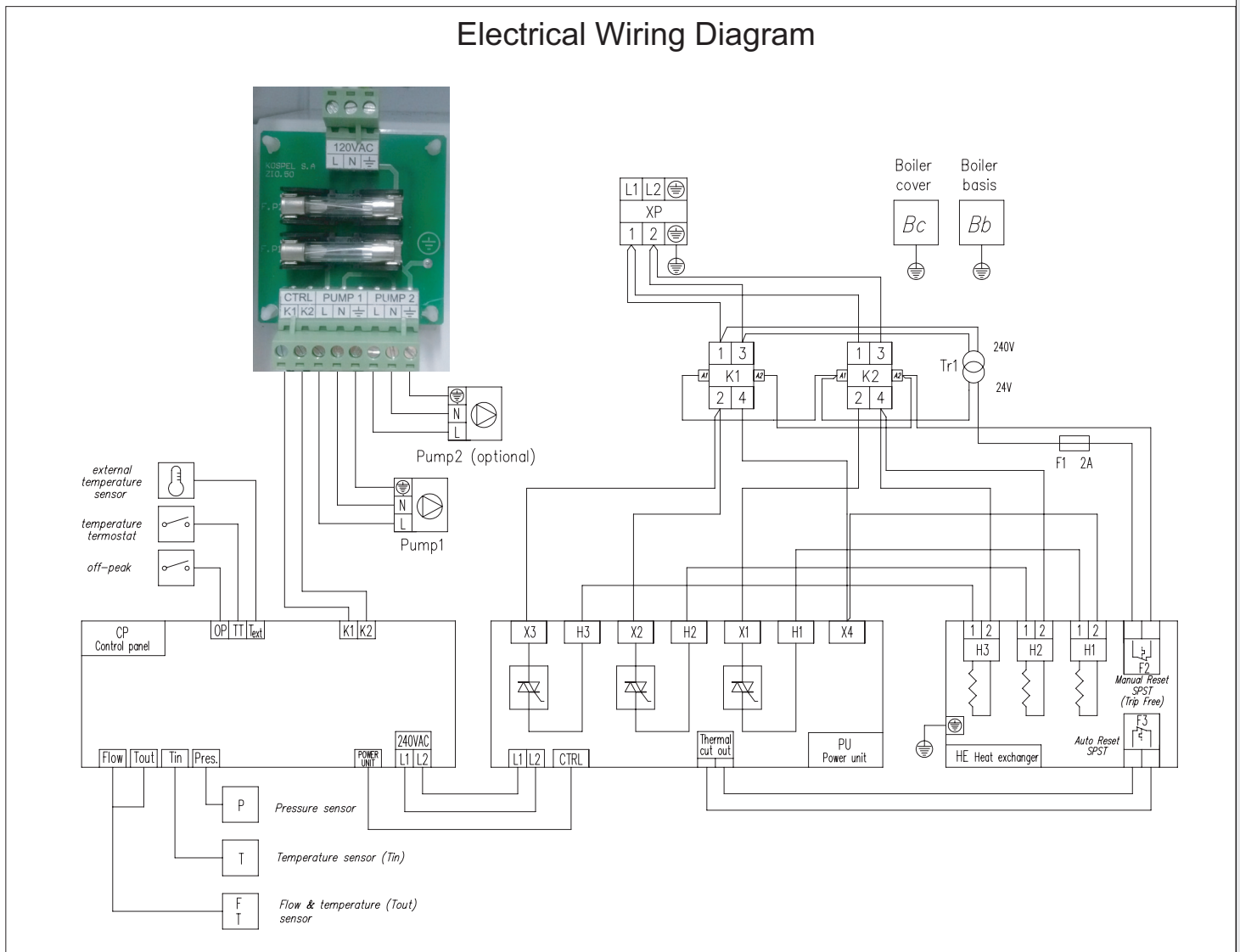

⚠ For supply connections, use 10 awg or larger wires suitable for at least 167°F (75°C)

1. All electrical work should be completed in accordance to local or state electrical and building codes.
2. This boiler must be electrically grounded in accordance with National Electrical Code ASNI/NFPA70, or local codes.
3. This boiler operates with 240 VAC single phase electrical power source.
4. Connect the boiler to the electrical service using **⚠ COPPER WIRE ONLY**. Tighten connections by using a 3/16" Hex key tool. Conform to local electrical codes for correct sizing of electrical breakers and size of electric conductor wires. Refer to boiler nameplate for current and kW ratings. Local electric codes may require an electrical disconnect.
5. **The circulating pump** requires a separate 120 VAC, 15 amp electrical circuit. Utilize 1/2" electrical knockout as marked on the left side of cabinet to access circulating pump wiring connections inside boiler. Do not combine the high voltage power for circulating pump with any thermostat or off peak low voltage wires.

An optional secondary pump can be installed in the system for hydronic applications plumbed with multiple circulators and or primary/secondary applications. Utilize the Pump 2 connections to operate the secondary pump. The secondary pump will automatically turn on upon closure of thermostat connections on control panel. Spare fuses are taped into the inside cover. Fuses specified as: Time-delay Glass Fuse 6.3 x 32mm 2A.

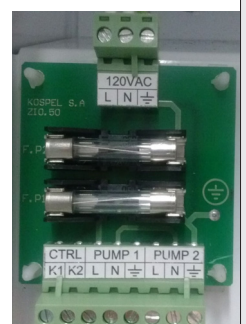
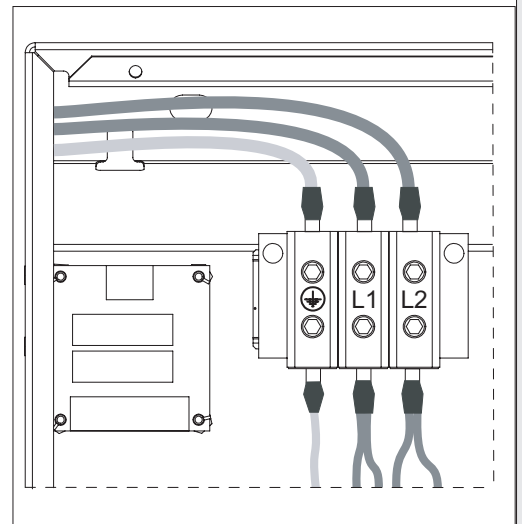

6. **Thermostat** - This boiler can be signaled to turn on from a standard two wire thermostat, end switches of an actuating valve or a zone control panel. These connections should all be voltage free (dry contact). Extend wires from thermostat to **TT** connections on control panel using 2 x 18 gauge wires. Utilize 1/2" electrical knockout to left side of control panel to gain entrance to this connection. Install thermostat in a location where it will not be influenced by other heat sources.
7. **Off peak control (optional)** -This boiler is equipped with a connection (normally closed) to receive a utility signal for off peak denoted by **OP** on the control board. Ensure the interconnection from utility radio receiver is voltage free (dry contact). Consult with local utility on questions with off-peak installations. Keep blue/white jumper wire in place if not connected to a utility radio receiver.
8. **Outdoor compensation** - The boiler can utilize an outdoor sensor for outdoor compensation capability. Install the outdoor sensor preferably on the north side of the building. Keep the outdoor sensor away from any sources of heat. Refer to Advanced Settings on page 14 to set proper heat curve. If no outdoor sensor is wired to the **T_{ext}** terminals on the control panel, the boiler will work in normal operation
9. Final check. Verify all electrical connections are tight. Loose connections can cause premature failures of electrical components. Once you have finished the above procedures and before starting the boiler, understand the control buttons and indicators on the control panel in the following page.
10. Re-fasten the screws on bottom (2) and top (1) to hold front door in place.

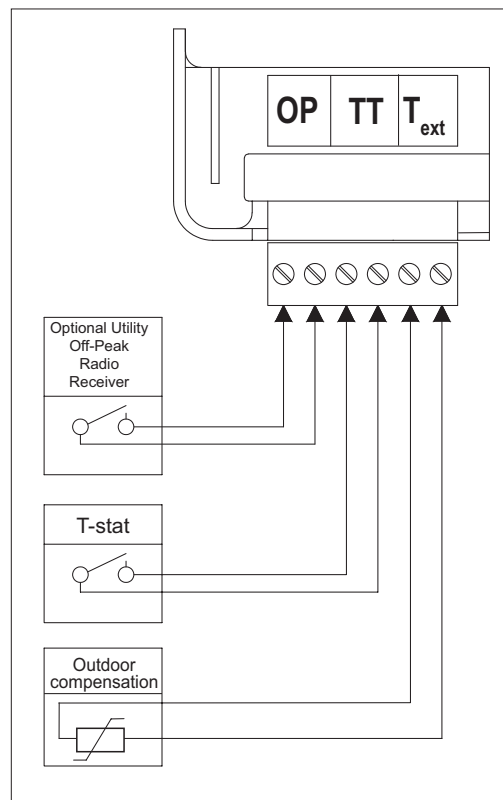

Control Panel

The control panel consists of two working areas: the signaling area and control buttons. The user can select the following working modes: winter mode (heating mode) or summer mode (stand-by mode). Utilize the push button arrows to scroll through the different working parameters of the boiler. The control panel will automatically switch to main view if no buttons are pressed within 1 minute. After learning the indicators proceed to initial startup section. The control panel allows the user to identify flow rate (GPM), the inlet and outlet operating temperatures and the Btu/h of the boiler at any given time. It will also aid in identifying any faults, which may occur, by displaying the fault codes.

Indicators

X 100 Btu/h = British thermal units per hour

psi = Pounds/Square Inch, pressure level

gpm = Gallons/minute or Flow rate

F° = Temperature (Fahrenheit)

Buttons



 = Boiler power

 = Up and down selection





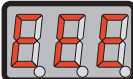

 = Scroll option



FAILURES INDICATION

INDICATOR	STATUS	DETAILS
	EEE Message on electronic display	Data record error
		Parameter out of range or a failed temperature sensor





Heating Mode / Initial Start-up

- To set in the heating mode press the power  button. The indicators will show the current working mode of the boiler.
- Set the supply water temperature (SWT) set point. Utilize the right arrow  push button to scroll through working parameters of the boiler. Highlight the  SWT symbol and utilize the up and down arrows  to select the temperature that meets hydronic radiant heating application. The supply water temperature can be set between 85° - 140°F. Notice the °F symbol will light up at the same time when changing temperature.
- If 120 VAC power is connected to the circulating pump, turn control panel on  and utilize push buttons to scroll to psi indicator. Disconnect thermostat wiring connection below control panel. This will insure boiler will not operate. If pressure is below the 7 psi level the circulating pump indicator will blink. Verify pressure (psi) reading on control panel to achieve desired pressure levels. Typical pressure readings should be slightly above the 12 psi expansion tank reading or higher depending on application (15-20 psi recommended).
- For testing, turn the thermostat above the room temperature reading. This will turn the boiler on. After testing return the thermostat to a comfort setting.
- To automatically return to main viewing mode momentarily press the power  button. The controller will switch over to the main view if you don't push any of the buttons for 1 minute.



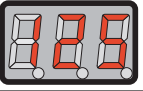

Winter Mode (Heating Mode)

To set in the heating mode press the power  button. The indicators will show the current parameters of the boiler (see control panel).

MAIN VIEW

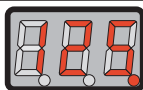
INDICATOR	STATUS	DETAILS
Heating Status		
	<input checked="" type="radio"/> on	Thermostat is calling for heat
	<input type="radio"/> off	Room set temperature has been reached/ no call for heating
	<input checked="" type="radio"/> blinks	Off Peak load control or master appliance mode. Outdoor temperature reached a thermal cut - off valve (see parameter 5 in advanced settings).
Circulating Pump Indicator		
	<input checked="" type="radio"/> on	Pump is active, proper flow rate of water has been reached
	<input checked="" type="radio"/> blinks	Lack of water flow or insufficient flow of water heating elements off
Supply Water Temperature		
	<input checked="" type="radio"/> red light	Boiler is in heating mode
	<input checked="" type="radio"/> green light	Supply water temperature has been reached in the boiler
	<input type="radio"/> off	Heating is off
Outlet Temperature		
<input checked="" type="radio"/> °F 		Temperature on the outlet of the boiler

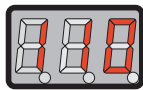
SUPPLY WATER TEMPERATURE VIEW

INDICATOR	STATUS	DETAILS
°F <input checked="" type="radio"/>		The LED in the first location on the display indicates automatic setting, according to the heating curve and offset (see parameters 4 and 5 in advanced settings). This is active only when the outdoor sensor is wired to T _{ext} terminals on control panel .
		
Manual setting (see parameter 4 in advanced settings), outlet temperature can be set manually in range 85 - 140°F. Use buttons  and  to change the parameter		

INLET TEMPERATURE VIEW

°F <input checked="" type="radio"/> 		Inlet temperature
---	---	-------------------

OUTLET TEMPERATURE VIEW

°F <input checked="" type="radio"/> 		Outlet temperature
---	---	--------------------

FLOW VIEW

gpm <input checked="" type="radio"/>		Flow rate [gallons/min.]
--------------------------------------	---	--------------------------

PRESSURE VIEW

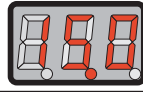
psi <input checked="" type="radio"/>		Pressure level [pounds/square inch]
--------------------------------------	---	-------------------------------------

ENERGY CONSUMPTION VIEW

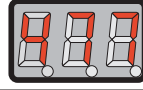
X100 BTU/h <input checked="" type="radio"/>		Current energy consumption [BTU/h]
---	---	------------------------------------

OUTDOOR TEMPERATURE VIEW

°F <input checked="" type="radio"/> 	Outdoor temperature. In case of lack of outdoor temperature sensor, preview is not available	
---	--	--

To use the outdoor compensation option refer to outdoor compensation graphs on page 14. The outlet temperature is adjusted depending on the outdoor temperature. For example, if it's cold, the outlet temperature should increase, but if outdoor temperature is warmer, the outlet temperature should be adjusted lower. Outdoor compensation option is based on heating curves (see "Advanced Settings").

User can choose from one of the 9 curves available, declaring the desired thermal efficiency of the boiler. One method of selecting the correct curve is as follows. The first step is to determine the temperature on the horizontal axis (outside temperature from 0°F to 70°F), which at the present time most frequently occurs, for example 30°F. Then run in a straight line up to the height on the value of the temperature on the vertical axis which we want to obtain in the hydronic system. In our example, at 30°F outside the building we want to have 115°F for the heating (see the diagram on page 14), so we get exactly the heating curve defined as 4. If the intersection point of selected temperatures is not placed on the curve, we choose the closest. For example, 30°F outdoor temperature, and the desired 110°F for hydronic system can lead to a selection of curve 3 or 4. It should be checked periodically, whether the choice was correct, if not - another curve should be used.



The heating curve offset

If in wide range of outdoor temperatures the boiler is not able to maintain the desired indoor temperature (it's too cold or too warm), the heating curve chosen before should be shifted (offset in range -9°F to +9°F available in options on control panel). If the indoor temperature is too warm - the heating curve should be shifted down and vice versa (refer to the diagram on page 14).

Special start-up procedure (when the system is filled with an antifreeze solution)







A flow rate reading error may occur if you start-up the unit at low ambient temperature. This error may occur because the physical properties of antifreeze solution. If the  indicator flickers and the cut-off valves are opened you have to close OP and TT contacts which will automatically start the special start-up procedure. As a result, the medium will be warmed up to temperature that enable you to read the flow rate correctly. The duration of procedure depends on both the installation capacity and the temperature inside the installation. When a control panel display shows selected parameters alternately and marks („-“, „--“, „---“) it means that the procedure is started. The procedure will close automatically and the unit will start normal operation once the minimal flow rate is reached.

Summer Mode (Stand-by Mode)

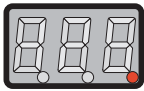
Important: Do not shut off the power supply between heating seasons. To set the boiler to summer or stand-by mode press and hold  power button for 3 seconds. When the control panel is switched to summer mode the control panel is off and the stand-by mode indicator  remains blinking. In this mode the boiler is off but the pump is activated every day for 15 minutes. This summer mode protects the boiler and the hydronic heating installation from being blocked and silted up. The pump will run every day at the same time when the boiler is switched to summer mode. For example, if you turn the boiler to “stand-by” mode at 6 p.m. the timer will activate the pump every day for 15 minutes starting at 6 p.m.

To set the boiler back to winter heating mode press and hold power button  for 3 seconds.

Note- In summer mode, based on U.S. national electric rates of \$.10/kWh the cost of operating the circulating pump for 15 minutes/day will equate to approximate usage of \$.08 / month on the highest speed.

MODE VIEW	
INDICATOR	DETAILS
	The control panel is off and the stand-by mode indicator (dot) blinks only .
PRESSURE VIEW	
psi  	Pressure level [pounds/square inch]. To check out the installation pressure press  or  .
STATUS PUMP VIEW	
	Circulation pump is active. In summer mode (heating elements turned off). The circulating pump will operate for 15 minutes, once every 24 hours each day.

Advanced Settings

For advanced settings switch the control panel to stand-by mode. First press and hold power button (⏻) for 3 seconds and release. Then press and hold the (▶) button, and immediately press the power button (⏻)

To select parameter press: (▶), (▲), or (▼) buttons to enable you to change the values.

Press and hold the power button (⏻) to exit and save the settings.

Parameters	Indicator/ display	Status/ value	DETAILS
1		4 - 14	Boiler power - enter the power amount (kW) as indicated on identification label. This value is factory preset.
2		A/n	Working mode of pump – PA = (automatic), Pn (manual – continuous duty of pump).
3		1,2,3	Maximum quantity of active heating elements.
4		off/on	Installation pressure control
5		30 - 70	Outside temperature above which boiler will not heat, in case of boiler's failure or lack of outside temperature sensor, function is not active
		off	Function not active
6		1 - 9	Selection of heating curves (see diagram "Outdoor compensation")
		0	Manual setting of outlet temperature
7		-9 ÷ 9	Offset of heating curve characteristic [°F] (see diagram "Offset for outdoor compensation")
8			Boiler working time counter in hours

Outdoor compensation

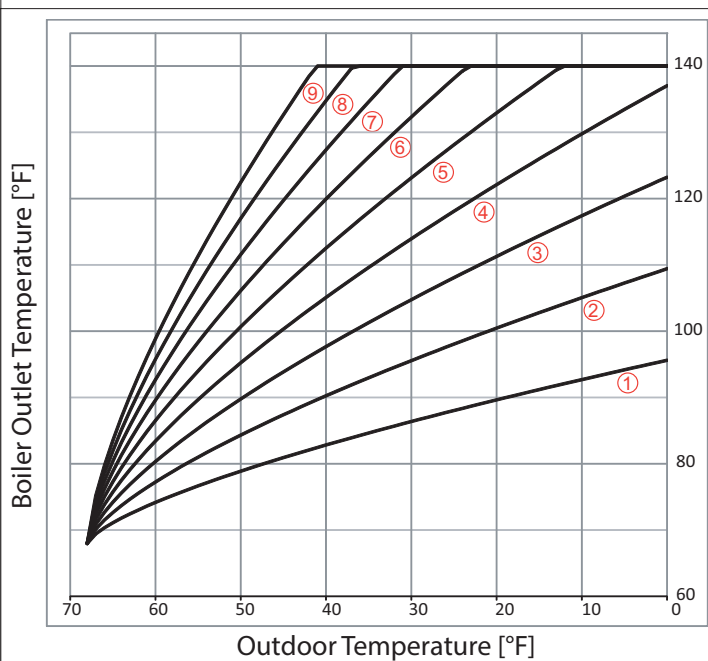



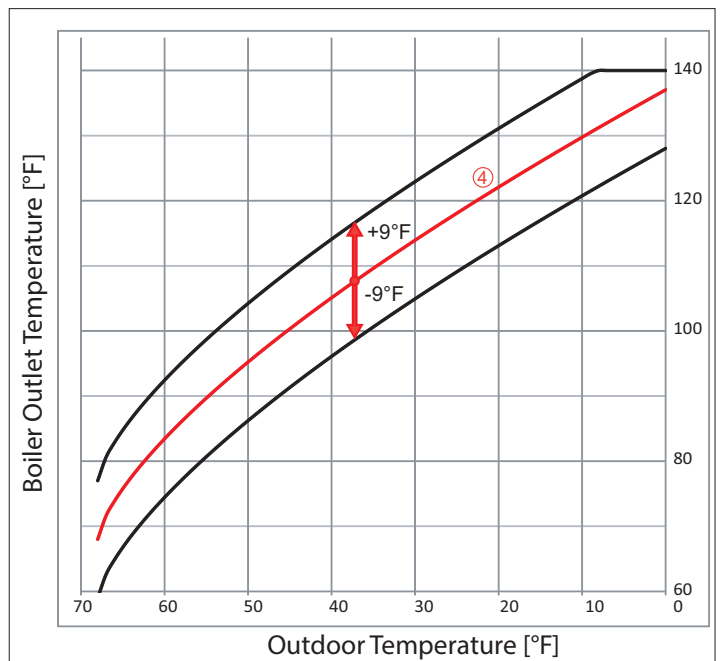

Offset for outdoor compensation



Troubleshooting

⚠ Do not attempt to service this boiler unless you have been trained in all aspects of its functionality and methods to repair. Failure to service properly may lead to further damage to components.

Symptom	Reason	Action
All indicators on control panel are OFF	No power to boiler	Check for 240 VAC on boiler main connection terminals
		Reset manual safety high limit
		Contact authorized service person
“PSI” indicator blinks	Insufficient pressure below 7 psi	Switch the controller to pressure view and increase system pressure above the minimum required 7 psi level.
	Pressure sensor failure	Switch the controller to pressure view, if display shows - - Contact authorized service person
“GPM” indicator blinks	Pump is blocked	Unblock the pump-unscrew the screw on pump housing and move the pump rotor manually
	Heat does not circulate through the boiler – boiler is blocked	Air bubble is caught in system, purge the installation, pump and boiler
		Check 1 amp fuse on control panel
	Failure of pump or flow sensor a failure of pump or flow sensor	Check power supply for circulating pump Contact an authorized service or the seller
 Circulator indicator blinks	Lack of water flow - 2.1 GPM min	Adjust flow characteristics as needed
 “Heating status” is off	No thermostat connection	Insure thermostat is calling for heat and is above ambient temperature set point Verify connections on thermostat
	Failure of control board	Check fuse on control panel glass fuse 6,3 x 32mm 2A
 “Heating status” blinks	Off Peak signal = no heat	Electric utility off peak control
 and “Inlet temp.” blinks	A failure of inlet temperature sensor, boiler in failure condition	Check connection or replace thermistor sensor
 and “Outlet temp.” blinks	A failure of outlet temperature sensor or loose connection	Check connections
		Replace HC-DN 15 sensor
Boiler does not heat	Failure of cylinder temperature sensor	Contact authorized service person for replacement of cylinder temperature sensor or thermostat
	A failure of control panel	Contact authorized service person
EEE message on display	Data record error	Contact authorized service person
Insufficient heat output	Heating elements	Check for resistance on elements
	Control panel set up failure	Insure control panel is set up for correct kW and number of heating elements through advanced settings

Instructions for the user

Care and Maintenance

- In order to protect flow sensor located within the boiler, it is imperative that the pre-installed magnetic filter is removed and cleaned at least annually. Failure to clean out this filter could increase contamination of the boiler by system residue.
- Periodically check system pressure. Contact authorized service person to make adjustments only.

General Boiler View

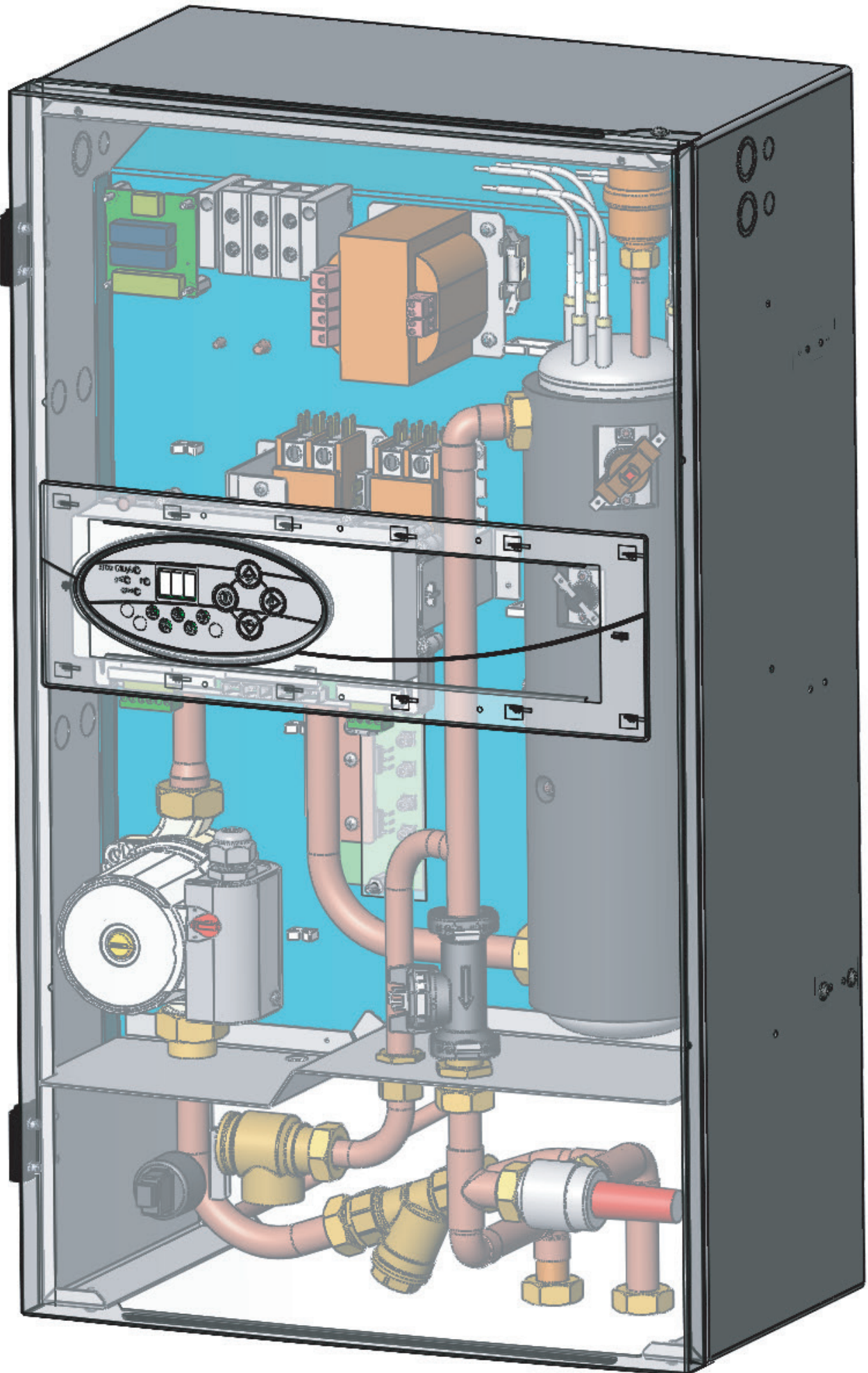

Instructions for the user

Part List

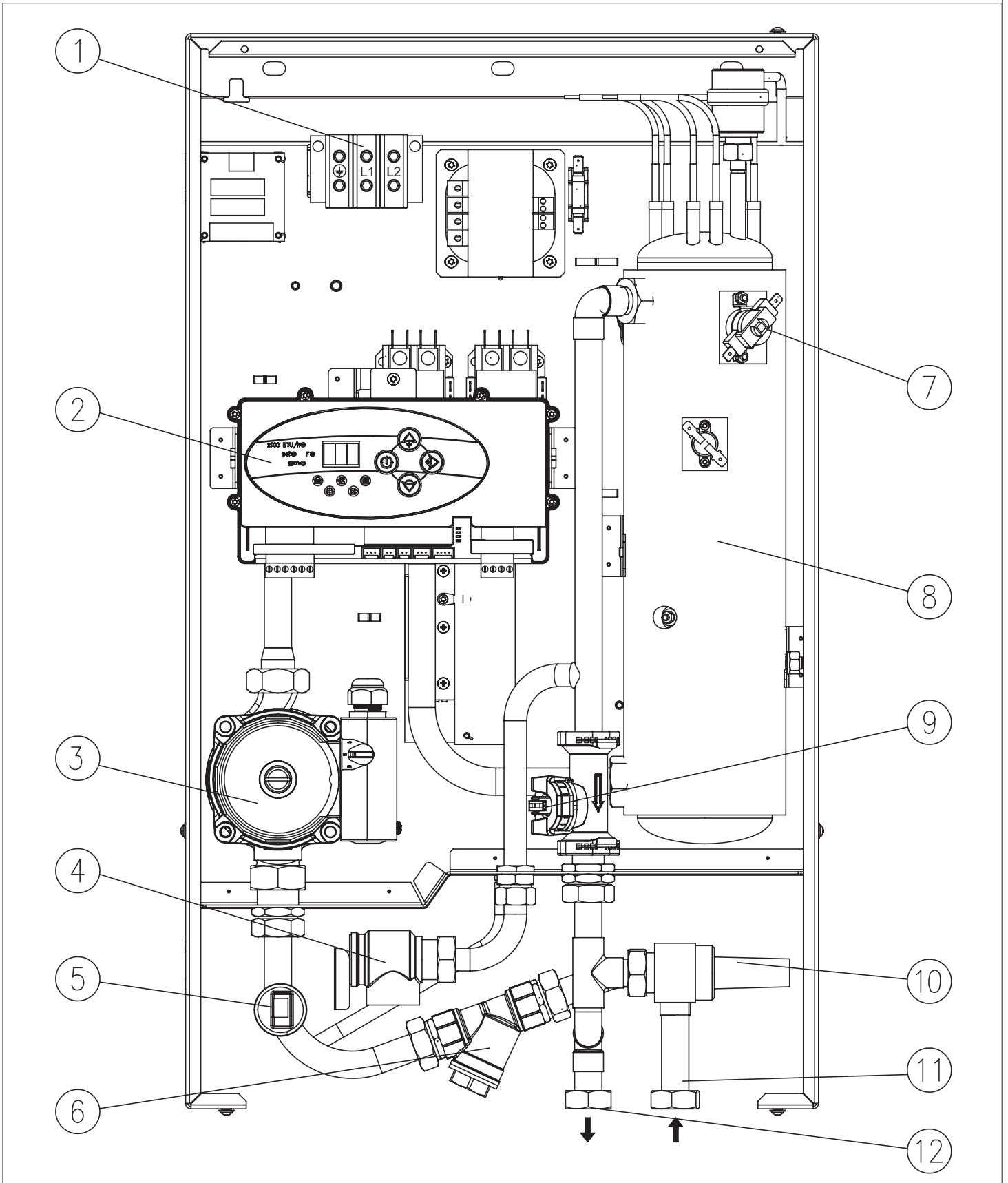

1.	Wiring Entrance	7.	Manual Reset High Limit Device
2.	Control Panel	8.	Heating Element
3.	Pump	9.	Flow and Outlet Temperature Sensor
4.	Pressure Relief Valve	10.	By-Pass Valve
5.	Pressure Sensor	11.	Water Inlet
6.	Magnetic Filter	12.	Water Outlet

Part #	Description
01563	Side Cover
01564	Outdoor Temperature Sensor
01591	Heat Exchanger - 4 kW/240V
01565	Heat Exchanger - 6 kW/240V
01566	Heat Exchanger - 8 kW/240V
01567	Heat Exchanger -12 kW/240V
01568	Heat Exchanger -14.4kW/240V
01569	Inlet Connection Pipe
01570	Pump Pipe EKCO.LN2UL
01571	Power Board ZM-60 (w/o pipe)
01572	Inner Pipe of Power Board
01573	Outlet Connection Pipe 1
01574	Outlet Connection Pipe 2
01575	Safety Valve Pipe
01576	Control Panel -Main Circuit Board
01577	Case
01578	Nipple 3/4"
01579	Nut
01580	Nut G 3/4"
01581	Connection
01582	Sleeve
01583	Panel ZIO.50
01584	Pump Wilo Star S21 U15 130 PR3
01585	Apollo Safety Relief Valve 30 psi, 3/4"
01586	Thermal Safety Cut Out 60T-X25, 90.05 Thermodisc
01587	Contactora HVVY2XQ04GG Hartland
01588	Transformer 4000-09AW18AE999
01589	Glass Fuse Connection 16A
01590	Time-delay Glass Fuse 6.3 x 32mm 2A
01592	Connector VC05-0046
01593	Holder KU-2 color Grey
01594	Thermal Cut Out (auto reset) 36T
01601	Return Temperature Sensor NTC
01294	Magnetic Filter F-Mag 3/4
01195	Differential Pressure Relief Valve
00853	Expansion Vessel
01339	Flow Sensor Huba Control

Limited Product Warranty

Kospel, S.A. warrants, and NextGen Boiler carries out, to the original purchaser to be free from manufacturing defects in materials and workmanship at the location of the original installation, except as noted below, for a period of 26 months from the date of manufacture. The NextGen Boiler must have been purchased from an authorized NextGen Boiler distributor. A Return Materials Authorization (RMA) form must be completed in full and returned along with the defective component(s), freight pre-paid

Exclusions or conditions that void warranty

1. Applications and installations that are in violation of state and/or federal codes or statutes.
2. Products that have been altered, replaced or repaired from original factory condition.
3. Damages from improper voltages or power supply wiring or voltage transients or spikes.
4. Damages due to natural disaster.
5. Component damage due to freezing or water quality conditions.
6. Incorrect application use other than intended as noted above.
7. Incorrect product sizing for the application.
8. Boilers not installed according to manufacturer's specifications and installation instructions as noted in the product installation manual.
9. Products that have internal wiring or parts altered or removed, bypassing of safety circuits, modifications of parts or circuit boards or mechanical water flow changes not authorized in writing by the manufacturer.
10. Unusual wear and tear of the product.
11. The name plate decal and the UL certification label (including serial number) are (either) defaced or destroyed.
12. Damages resulting in shipment or handling by the freight carrier. It is the receiver's responsibility to claim and process freight damage caused by others.

Replacement parts under this limited warranty do not extend the warranty term or period.

Kospel, S.A. and NextGen Boiler are not bound by representatives, installers, warranties or promises made by others beyond the terms of this limited warranty. In no way shall Kospel, S.A. or NextGen Boiler be responsible for any installation, incidental or consequential damage.

Kospel, S.A. and NextGen Boiler (or an authorized representative from either) has the right to inspect any reported defective products and/or parts. Materials are to be returned at owner's expense.

This warranty gives you specific legal rights, and you may also have other rights which vary from states to state.

Warranty Registration

NextGen Boiler
NextGen Boiler Warranty Registration
550 Albion Ave. Ste. 170
Schaumburg, IL 60193
info@nextgenboiler.com

NextGen Boiler Warranty Registration

Name _____

Address _____

City _____ State _____ Zip code _____

Telephone _____

Model # _____ Serial # _____

Installer Name _____ Telephone _____

Date Installed _____

Warranty registration must be filled out completely and mailed or emailed within Sixty (60) days of installation in order to gain warranty coverage.

