

Installation Manual

Viega Basic Heating Control



viega

Table of Contents

| | | |
|----------|--|-----------|
| 1 | About this Document | 5 |
| 1.1 | Disclaimer | 5 |
| 1.2 | Symbols Used | 5 |
| 2 | Product Information | 6 |
| 2.1 | Basic Heating Control | 6 |
| 3 | General Operation | 7 |
| 3.1 | Using the Control | 7 |
| 3.1.1 | Item | 7 |
| 3.1.2 | Adjust | 7 |
| 3.2 | Description of Display | 8 |
| 3.3 | Control Operation | 8 |
| 3.4 | Control Features | 9 |
| 3.4.1 | Outdoor Reset | 9 |
| 3.4.2 | Floating Action | 9 |
| 3.4.3 | Warm Weather Shut Down (WWSD) | 9 |
| 3.4.4 | Exercising | 9 |
| 3.5 | Temperature Control | 10 |
| 3.5.1 | System Circulator Pump Operation (Sys Pmp) | 10 |
| 3.5.2 | Mixing Target Temperature (MIX TARGET) | 10 |
| 3.5.3 | Indoor Sensor (Optional) | 10 |
| 3.6 | Temperature Control Installer Information | 10 |
| 3.6.1 | Outdoor Design (OUTDR DSGN) | 10 |
| 3.6.2 | Room (Room) | 11 |
| 3.6.3 | Mix Design (MIX DSGN) | 11 |
| 3.7 | Temperature Control Advanced Information | 11 |
| 3.7.1 | Mixing Indoor (MIX INDR) | 11 |
| 3.7.2 | Mixing Maximum (MIX MAX) | 11 |
| 3.7.3 | Warm Weather Shut Down (WWSD) | 11 |
| 3.8 | Boiler Control | 12 |
| 3.8.1 | Boiler Operation | 12 |
| 3.8.2 | Boiler Enable | 12 |
| 4 | Installation | 13 |
| 4.1 | Mounting and Rough-in | 13 |
| 4.1.1 | Mounting | 14 |
| 4.1.2 | Rough-In | 15 |
| 4.1.3 | Installing the Outdoor Sensor | 16 |
| 4.1.4 | Installing the Supply Sensor | 17 |
| 4.2 | Electrical Connections | 17 |
| 4.2.1 | Powered Input Connection | 18 |
| 4.2.1.1 | 120V AC Power | 18 |
| 4.2.2 | Output Connections | 18 |
| 4.2.2.1 | System Circulator Pump Contacts (Sys Pmp) | 18 |
| 4.2.2.2 | Valve Actuator | 18 |

| | | |
|----------|---|-----------|
| 4.2.3 | Sensor and Unpowered Input Connections | 19 |
| 4.2.3.1 | Outdoor Sensor | 19 |
| 4.2.3.2 | Supply Sensor | 19 |
| 4.2.3.3 | Indoor Sensor | 19 |
| 4.3 | Testing the Wiring | 20 |
| 4.3.1 | Testing the Sensors | 20 |
| 4.3.2 | Testing the Power Supply | 20 |
| 4.3.3 | Testing the Outputs | 21 |
| 4.3.3.1 | System Circulator Pump (Sys Pmp) | 21 |
| 4.3.3.2 | Boiler | 21 |
| 4.3.4 | Connecting the Control | 21 |
| 4.3.4.1 | Mixing or Injection Valve Actuator | 21 |
| 4.4 | DIP Switch Settings | 22 |
| 4.4.1 | Advanced/Installer | 22 |
| 4.4.2 | Boiler Enable 30% - Boiler Enable 10% | 22 |
| 4.4.3 | Bloc / Station | 22 |
| 4.5 | View Menu Display Settings | 23 |
| 4.5.1 | OUTDR | 23 |
| 4.5.2 | ROOM | 23 |
| 4.5.3 | MIX | 23 |
| 4.5.4 | MIX TARGET | 23 |
| 4.6 | Adjust Menu Display Settings | 24 |
| 4.6.1 | ROOM | 24 |
| 4.6.2 | OUTDR DSGN | 24 |
| 4.6.3 | MIX DSGN | 24 |
| 4.6.4 | MIX INDR | 24 |
| 4.6.5 | MIX MAX | 25 |
| 4.6.6 | WWSD | 25 |
| 4.6.7 | UNITS | 25 |
| 4.7 | Testing the Control | 26 |
| 4.7.1 | Test Sequence | 26 |
| 4.7.2 | Testing Sensors | 26 |
| 5 | Troubleshooting | 28 |
| 5.1 | Underheating | 29 |
| 5.2 | Overheating | 29 |
| 5.3 | Error Messages | 30 |
| 5.3.1 | E01 | 30 |
| 5.3.2 | Shr (OUTDR) | 30 |
| 5.3.3 | OPn (OUTDR) | 30 |
| 5.3.4 | Shr (MIX) | 30 |
| 5.3.5 | OPn (MIX) | 31 |
| 5.3.6 | Shr (ROOM) | 31 |
| 5.3.7 | OPn (ROOM) | 31 |
| 6 | Mechanical and Electrical Diagrams | 32 |
| 6.1 | Mechanical Schematic | 32 |
| 6.2 | Electrical Schematic | 32 |
| 7 | Technical Data | 33 |
| 8 | Limited Warranty | 34 |

1 About this Document

1.1 Disclaimer



Viega products are designed to be installed by licensed and trained plumbing and mechanical professionals who are familiar with Viega products and their installation. **Installation by non-professionals may void Viega LLC's warranty.**



This document is subject to updates. For the most current Viega technical literature please visit www.viega.us.

1.2 Symbols Used

The following symbols may be used within this document:



DANGER!

This symbol warns of possible life-threatening injury.



WARNING!

This symbol warns of possible serious injury.



CAUTION!

This symbol warns of possible injury.



NOTICE!

This symbol warns of possible damage to property.



Notes give additional helpful tips.

2 Product Information

2.1 Basic Heating Control

The Viega Basic Heating Control is designed to control the supply water temperature to a hydronic system in order to provide outdoor reset operation. The Basic Heating Control uses a floating action actuator mounted on a diverting or mixing valve to regulate the supply water temperature. The control has a Liquid Crystal Display (LCD) to view system status and operating information.

Additional functions include:

- User comfort adjustment to increase or decrease building space temperature.
- Advanced settings to fine-tune building requirements.
- Optional indoor sensor for room air temperature control (Part Number 16016).
- Test sequence to ensure proper component operation.
- 120V AC power supply.
- Powered system circulator pump output.
- CSA C US certified (approved to applicable UL standards).

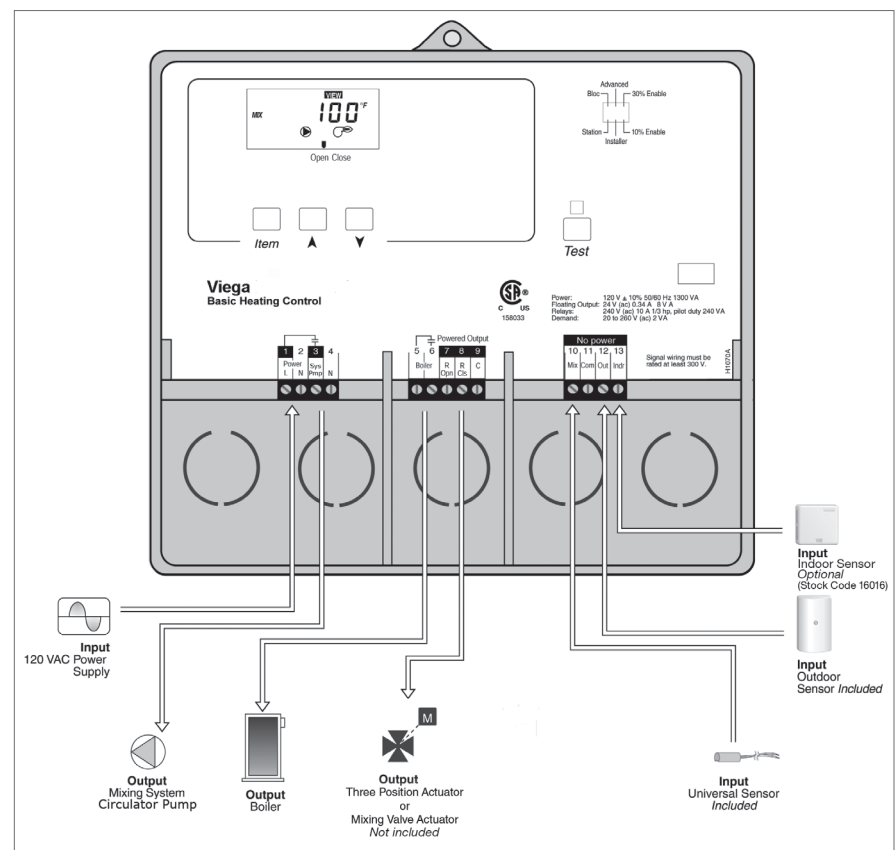

3 General Operation

3.1 Using the Control

The Basic Heating Control uses a Liquid Crystal Display (LCD) as the method of supplying information. You use the LCD in order to set up and monitor the operation of your system. The Basic Heating Control has three push buttons (**Item**, **▲**, **▼**) for selecting and adjusting settings. As you program your control, record your Adjust Menu settings for future reference or troubleshooting.

3.1.1 Item

The abbreviated name of the selected item will be displayed in the item field of the display. To view the next available item, press and release the **Item** button. Once you have reached the last available item, pressing and releasing the **Item** button will return the display to the first item.

3.1.2 Adjust

To make an adjustment to a setting in the control, press and hold simultaneously for one second, the **Item**, **▲** and **▼** buttons. The display will then show the word **ADJUST** in the top right corner. Then select the desired item using the **Item** button. Finally, use the **▲** and/or **▼** button to make the adjustment.

To exit the adjust menu, the control must be left alone for 20 seconds.

When the **Item** button is pressed and held in the **VIEW** menu, the control scrolls through all the control adjust items in both access levels.

Additional information can be gained by observing the Status Field and Pointers of the LCD. The Status Field will indicate which of the control's outputs are currently active. Most symbols in the status field are only visible when the **VIEW** menu is selected.

3.2 Description of Display



Circulator

Displays when the system circulator is in operation



Burner

Displays when the boiler relay is turned on

°F

°F, °C

°C

Displays the units of measurement that all of the temperatures are to be displayed in the control



Pointer

Displays the actuator operation as indicated (open/close)

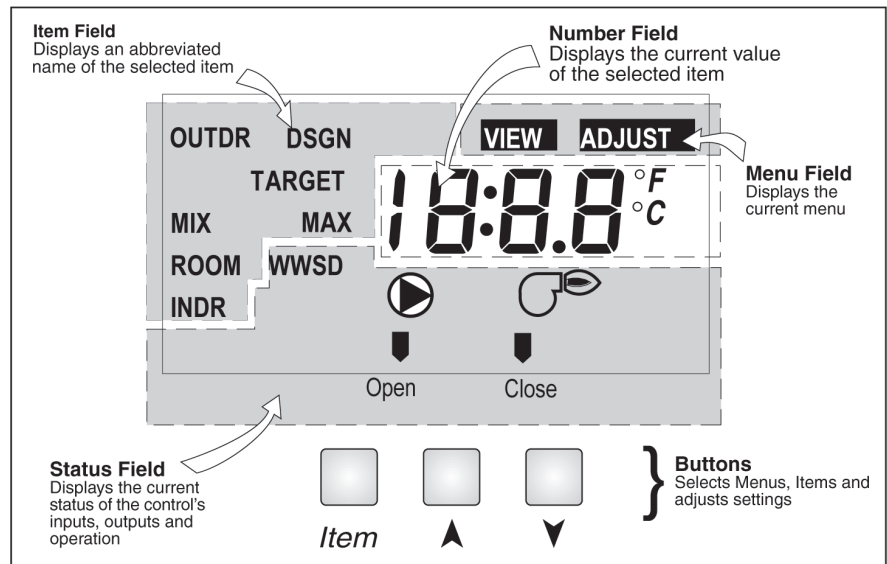

3.3 Control Operation

When the Basic Heating Control is powered up, the control displays the control type number in the LCD for two seconds. Next, the software version is displayed for two seconds. Finally, the control enters into the normal operating mode.

The Basic Heating Control uses a floating action that can control Viega diverting or mixing valves to vary the supply water temperature to a hydronic system. The supply water temperature is based on the outdoor temperature.

The maximum water temperature setting in the Basic Heating Control should not be used as a safety high limit control. To protect floors from high water temperatures in case of main control failure or removal, make sure high limit is set on mixing device.

3.4 Control Features

3.4.1 Outdoor Reset

The Basic Heating Control calculates a mixing supply water temperature based on the outdoor air temperature. The Basic Heating Control uses a heating curve and optional indoor temperature feedback from an indoor sensor in this calculation.

3.4.2 Floating Action

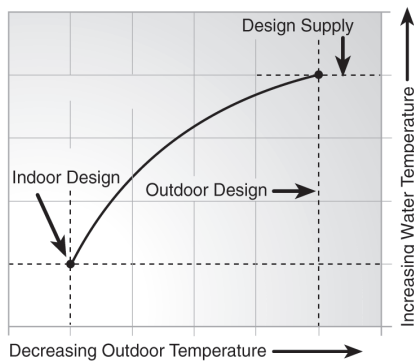

A 24V AC floating action actuator motor is connected directly to the Basic Heating Control on the COM, OPN, and CLS terminals (7, 8, and 9). The Basic Heating Control pulses the actuator motor open or closed to maintain the correct mixed supply water temperature at the supply sensor. The valve that the actuator is connected to can be either an injection valve (on the Injection Station), a mixing valve, or a diverting valve. A visual indication as to whether the control is currently opening or closing the mixing valve is displayed in the LCD.

3.4.3 Warm Weather Shut Down (WWSD)

The Basic Heating Control monitors the outdoor temperature and shuts off the heating system seasonally when outdoor temperatures exceed the Warm Weather Shut Down setting. This reduces energy use during the summer when the heating system is not needed and saves wear on system components.

3.4.4 Exercising

The Basic Heating Control has a built-in exercising function. If the system pump or valve has not been operated at least once every three days, the control turns on the output for a minimum of 10 seconds. This minimizes the possibility of a circulator pump or valve seizing during a long period of inactivity. The Basic Heating Control ensures that the mixing valve operates over its entire range at least once each exercising period. While the control is exercising, the Test LED flashes.



The exercising function does not work if power to the control, circulator, or valve is disconnected.

3.5 Temperature Control

3.6.1 System Circulator Pump Operation (Sys Pmp)

The system circulator pump contact (Sys Pmp, terminal 3) remains closed as long as the Basic Heating Control is not in Warm Weather Shut Down. During WWSD, the system Circulator is operated periodically based on the Exercise feature.

3.6.2 Mixing Target Temperature (MIX TARGET)

The MIX TARGET temperature is calculated from the heating curve settings, outdoor air temperature, and optionally, indoor air temperature. The control displays the temperature that it is currently trying to maintain as the mixing supply temperature.

3.6.3 Indoor Sensor (Optional)

An indoor sensor may be used in order to provide indoor temperature feedback. The indoor sensor is connected to the COM and INDR terminals (11 and 13). With the indoor sensor connected, the Basic Heating Control is able to measure the actual room temperature. With this information, the Basic Heating Control fine-tunes the supply water temperature in the mixing system to prevent overheating or underheating. To adjust the room temperature for the mixing zone, use the ROOM setting in the ADJUST menu at the control.

3.6 Temperature Control Installer Information

3.6.4 Outdoor Design (OUTDR DSGN)

The OUTDR DSGN is the outdoor air temperature that is typically the coldest temperature of the year where the building is located. This temperature is used when performing the heat loss calculations for the building. If a cold outdoor design temperature is selected, the mixing supply temperature rises gradually as the outdoor temperature drops. If a warm outdoor design temperature is selected, the mixing supply temperature rises rapidly as the outdoor temperature drops.

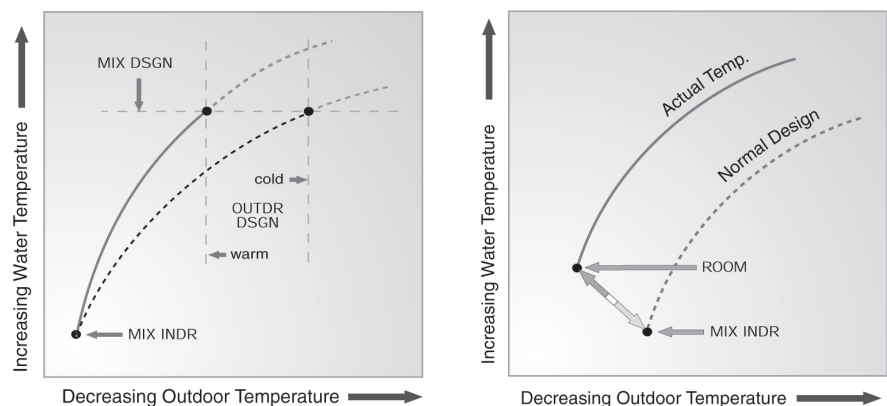

3.6.5 Room (Room)

The ROOM is the desired room temperature for the mixing zones and it provides a parallel shift of the Heating Curve. The room temperature desired by the occupants is often different from the design indoor temperature (MIX INDR). If the room temperature is not correct, adjusting the ROOM setting increases or decreases the amount of heat available to the building.

3.6.6 Mix Design (MIX DSGN)

The MIX DSGN temperature is the supply water temperature required to heat the mixing zones when the outdoor air is as cold as the OUTDR DSGN temperature.

3.7 Temperature Control Advanced Information

3.7.1 Mixing Indoor (MIX INDR)

The MIX INDR is the room temperature used in the original heat loss calculations for the building. This setting establishes the beginning of the Heating Curve for the mixing zones.

3.7.2 Mixing Maximum (MIX MAX)

The MIX MAX sets the highest water temperature that the control is allowed to calculate as the MIX TARGET temperature. If the control does target the MIX MAX setting, and the MIX temperature is near the MIX MAX, the MAX segment will be displayed in the LCD while either the MIX TARGET temperature or the MIX temperature is being viewed.

3.7.3 Warm Weather Shut Down (WWSD)

When the outdoor air temperature rises above the WWSD setting, the Basic Heating Control turns on the WWSD segment in the display. When the control is in Warm Weather Shut Down, the control does not operate the heating system (except for exercising - see "3.4.4 Exercising" on page 9).

3.8 Boiler Control

3.8.1 Boiler Operation

When the Basic Heating Control determines that boiler operation is required, the boiler contact terminals (5 and 6) close. While the boiler contact is closed, the burner segment in the LCD is displayed.

3.8.2 Boiler Enable

Boiler Enable 30% / Boiler Enable 10%)

The Basic Heating Control has a DIP switch that allows for the selection between a 30% boiler enable and a 10% boiler enable. In the 30% position, the Basic Heating Control closes the boiler contact when the position of the mixing valve exceeds 30%. The boiler contact remains closed until the position of the mixing valve reduces below 15%. This setting would normally be chosen for low mass boilers (copper fin tube, etc.), or systems with low thermal mass in the loop between the boiler and the mixing valve (recommended for most Viega applications).

In the 10% position, the Basic Heating Control closes the boiler contact when the position of the mixing valve exceeds 10%. The boiler contact remains closed until the position of the mixing valve reduces below 5%. This setting is normally chosen for high mass boilers (cast iron, steel fire tube, etc.) or systems with large thermal mass in the loop between the boiler and the mixing valve.

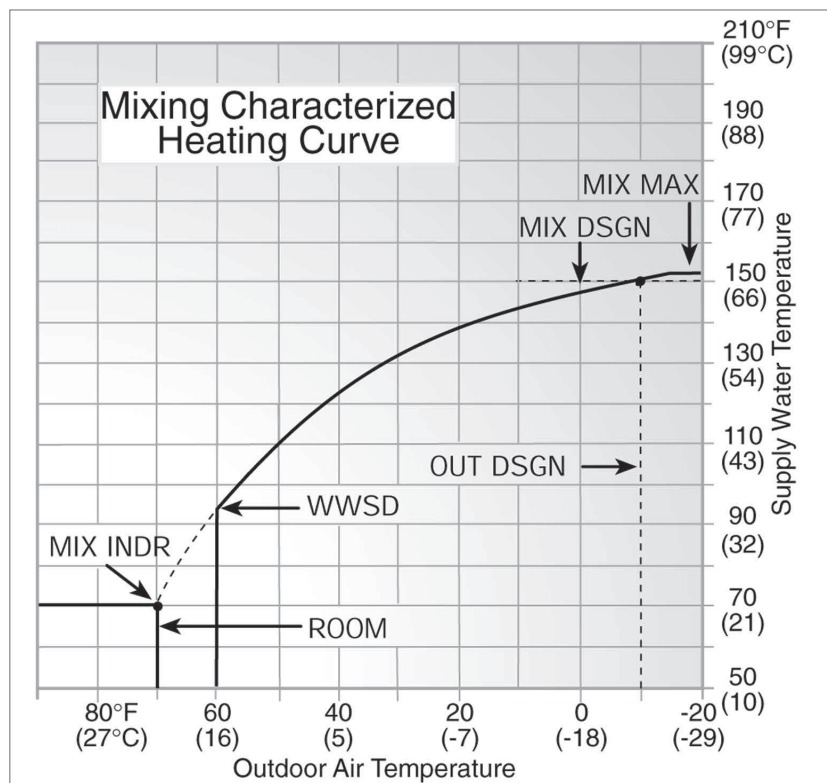

4 Installation



CAUTION!

Improper installation and operation of this control could result in damage to the equipment and possibly even personal injury. It is your responsibility to ensure that this control is safely installed according to all applicable codes and standards. This electronic control is not intended for use as a primary limit control. Other controls that are intended and certified as safety limits must be placed into the control circuit.

4.1 Mounting and Rough-in

Check the contents of this package. If any of the contents listed are missing or damaged, please contact your wholesaler or sales representative for assistance.

The Basic Heating Control includes: One Basic Heating Control, One Outdoor Sensor, and One Supply Sensor.



Carefully read the details of the Sequence of Operation to ensure that you have chosen the proper control for your application.

4.1.1 Mounting

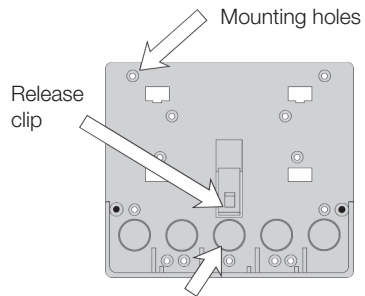

Remove the control from its base by pressing down on the release clip in the wiring chamber and sliding the control upward. The base may then be mounted by screwing it to a wall or mounting board (screws not included).

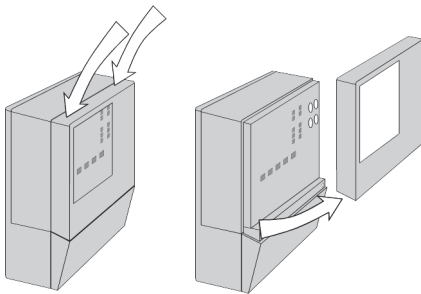

1. Press down at grips on top of cover, then pull out and down to release cover.

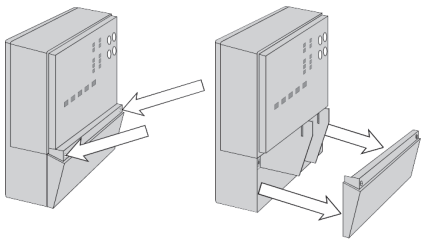

2. Loosen screws at front and pull wiring cover straight out.

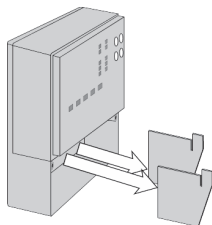

3. Remove safety dividers by pulling them straight out.

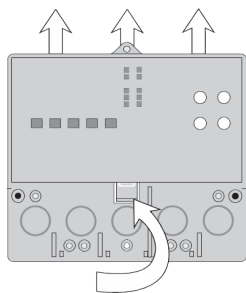

4. Press release clip on base and slide control upward.

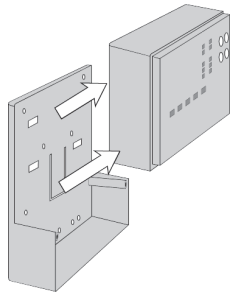

5. The control lifts up and away from the base, which is ready for mounting.

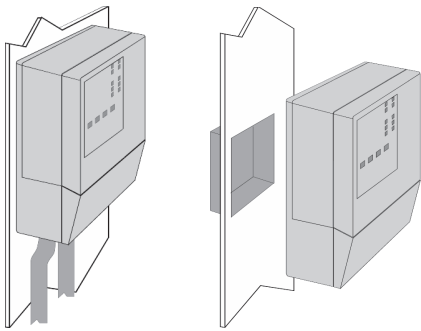

6. Wiring can enter from bottom or back of enclosure. Knockouts allow wiring to be run in conduit.

4.1.2 Rough-In

All electrical wiring terminates in the control base wiring chamber. The base has standard 7/8" (22 mm) knockouts, which accept common wiring hardware and conduit fittings. Before removing the knockouts, check the wiring diagram and select those sections of the chamber with common voltages. Do not allow the wiring to cross between sections as the wires will interfere with safety dividers that should be installed at a later time.

Power must not be applied to any of the wires during the rough-in wiring stage.

- Install the Outdoor Sensor and Supply Sensor according to the instructions on the next two pages and run the wiring back to the control.
- If an Indoor Sensor (optional) is used, install the sensor according to the instructions included with it and run the wiring back to the control.
- Run wire from other system components (circulator pump, boiler, actuating motor, etc.) to the control.
- Run wires from the 120V AC power to the control. Use a clean power source to ensure proper operation. Multi-strand 16 AWG wire is recommended for all 120V AC wiring due to its superior flexibility and ease of installation into the terminals.

4.1.3 Installing the Outdoor Sensor

The Outdoor Sensor includes a 10kΩ thermistor that provides an accurate measurement of the outdoor temperature. The sensor is protected by a white U.V. resistant plastic enclosure.

Remove the screw and pull the front cover off the sensor enclosure.

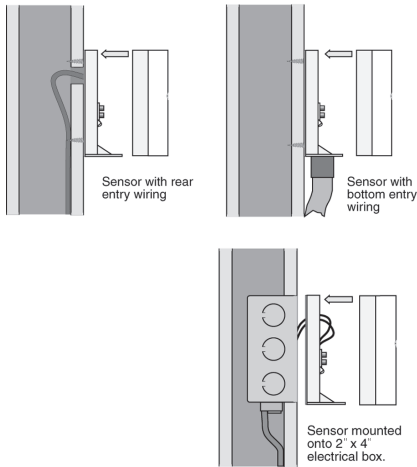

The Outdoor Sensor can either be mounted directly onto a wall or a 2" x 4" electrical box. When the sensor is wall mounted, the wiring should enter through the back or bottom of the enclosure. Do not mount the sensor with the conduit knockout facing upward as rain could enter the enclosure and damage the sensor.

In order to prevent heat transmitted through the wall from affecting the sensor reading, it may be necessary to install an insulating barrier behind the enclosure.

The Outdoor Sensor should be mounted on a wall that best represents the heat load on the building (a northern wall for most buildings, and a southern facing wall for buildings with large south facing glass areas). The sensor should not be exposed to heat sources such as ventilation or window openings.

The Outdoor Sensor should be installed at an elevation above the ground that will prevent accidental damage or tampering, and where it will not be covered by drifting snow during the winter.

Connect 18 AWG or similar wire to the two terminals provided in the enclosure and run the wires from the sensor to the control. Do not run the wires parallel to telephone or power cables. If the sensor wires are located in an area with strong sources of electromagnetic interference (EMI), shielded cable or twisted pair should be used or the wires can be run in a grounded metal conduit. If using shielded cable, the shield wire should be connected to the COM sensor terminal on the control and not to earth ground.

Replace the front cover of the sensor enclosure.

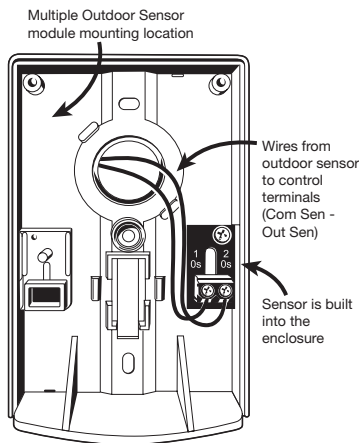

When more than one Basic Heating Control is used on a project, the Outdoor Sensors can be combined into one enclosure by adding the Multiple Outdoor Sensor module (part number 16020). This mounts in the Outdoor Sensor enclosure and allows up to four controls to have outdoor sensors within one enclosure.

4.1.4 Installing the Supply Sensor



This sensor is designed to mount on a pipe or in a temperature immersion well.

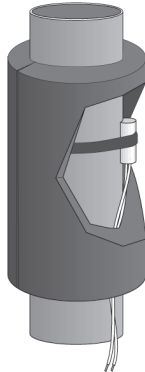

The Supply Sensor can be strapped directly to the pipe using a plastic cable tie. Insulation should be placed around the sensor to reduce the effect of air currents on the sensor measurement.

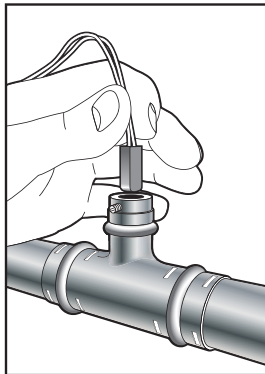

The Supply Sensor should be placed downstream of a circulator pump or after an elbow or similar fitting. This is especially important if large diameter pipes are used, as the thermal stratification within the pipe can result in erroneous sensor readings. Proper sensor location requires that the fluid is thoroughly mixed within the pipe before it reaches the sensor. When using the Supply Sensor with a Mixing Station, insert the sensor into the immersion well, see image to the left.

When using the supply sensor with a ProBloc insert the sensor into the immersion well located in the supply valve body. Connect 18 AWG or similar wire to the two wires of the sensor and then to the control. Do not run the wires parallel to telephone or power cables. If the sensor wires are located in an area with strong sources of electromagnetic interference (EMI), shielded cable or twisted pair should be used or the wires can be run in a grounded metal conduit. If using shielded cable, the shield wire should be connected to the COM sensor terminal on the control and not to earth ground.

4.2 Electrical Connections

The installer should test to confirm that no voltage is present at any of the wires. Push the control into the base and slide it down until it snaps firmly into place

4.2.1 Powered Input Connection

4.2.1.1 120V AC Power

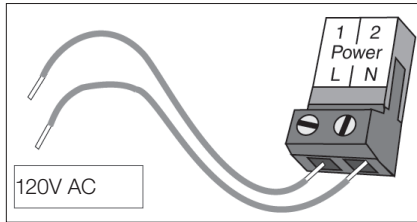

Connect the 120V AC power supply to the Power L and Power N terminals (1 and 2). This connection provides power to the microprocessor and display of the control. As well, this connection provides power to the Sys Pmp terminal (3) from the Power L terminal (1).

4.2.2 Output Connections

4.2.2.1 System Circulator Pump Contacts (Sys Pmp)

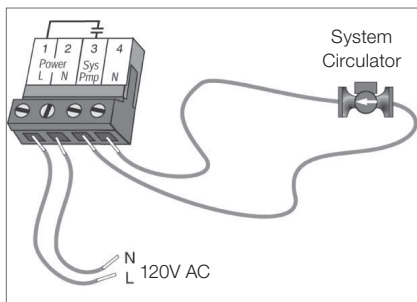

The Sys Pmp output terminal (3) on the Basic Heating Control is a powered output. When the relay in the Basic Heating Control closes, 120V AC is provided to the Sys Pmp terminal (3) from the Power L terminal (1). To operate the system circulator, connect one side of the system circulator circuit to terminal (3) and the second side of the circulator circuit to the neutral (N) terminal (4).

4.2.2.2 Valve Actuator

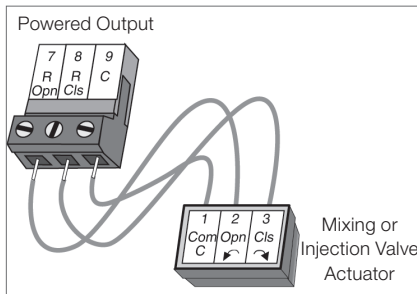

Terminals 7, 8, and 9 are powered with 24V AC from the control. There is no need to provide a separate 24V AC power source for the valve actuator.

R Opn (7) is connected to the open terminal of the actuating motor and R Cls (8) is connected to the close terminal of the actuating motor. C (9) is then connected to the common terminal of the actuating motor.

Three Position Actuator for Stations (Part Number 18003)

White wire is common
Green wire is open
Brown wire is close

Mixing Valve Actuator (Part Number 20042)

Blue wire is common
Brown wire is clockwise rotation
Black wire is counter-clockwise rotation
(Whether clockwise is open or close will depend on the orientation of the Mixing Valve – see valve instructions for details)

Boiler Contact

The Boiler terminals (5 and 6) are an isolated (dry) output in the Basic Heating Control. There is no power available on these terminals from the control. These terminals are to be used as a switch to either make or break the boiler circuit. When the Basic Heating Control requires the boiler to fire, it closes the contact between terminals 5 and 6.

4.2.3 Sensor and Unpowered Input Connections

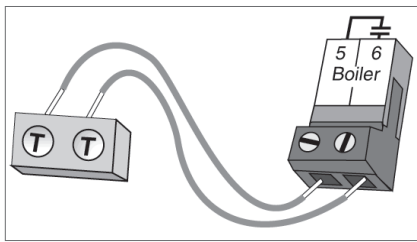

Do not apply power to these terminals as this will damage the control.

4.2.3.1 Outdoor Sensor

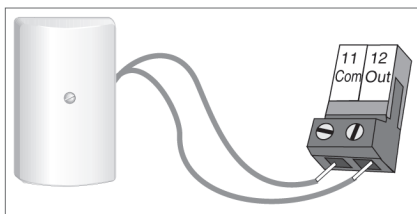

Connect the two wires from the Outdoor Sensor to the Com and Out terminals (11 and 12). The Outdoor Sensor is used by the Basic Heating Control to measure the outdoor air temperature.

4.2.3.2 Supply Sensor

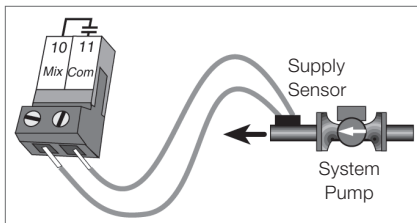

Connect the two wires from the Supply Sensor to the Com and Mix terminals (10 and 11). The Supply Sensor is used by the Basic Heating Control to measure the supply water temperature downstream of the diverting or mixing valve.

4.2.3.3 Indoor Sensor

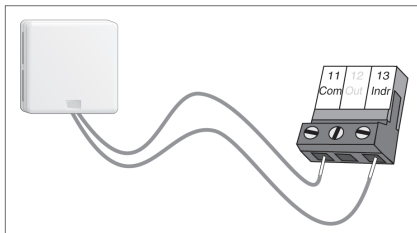

If an optional indoor sensor (Part Number 16016) is used, connect the two wires from the sensor to the Com and Indr terminals (11 and 13) (Part Number 16016).

4.3 Testing the Wiring



Each terminal block must be unplugged from its header on the control before power is applied for testing. To remove the terminal block, pull straight down from the control.

The following tests are to be performed using standard testing practices and procedures and should only be carried out by properly trained and experienced persons.

A good quality electrical test meter, capable of reading at least 0 - 300V AC and at least 0 - 2,000,000 Ohms, is essential to properly test the wiring and sensors.

4.3.1 Testing the Sensors

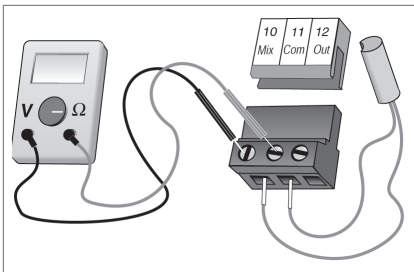

In order to test the sensors, the actual temperature at each sensor location must be measured. A good quality digital thermometer with a surface temperature probe is recommended for ease of use and accuracy. Where a digital thermometer is not available, a spare sensor can be strapped alongside the one to be tested and the readings compared. Test the sensors according to the instructions (see "4.7 Testing the Control" on page 26

4.3.2 Testing the Power Supply

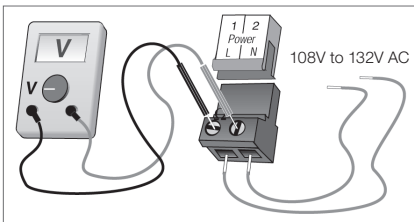

Make sure exposed wires and bare terminals are not in contact with other wires or grounded surfaces. Turn on the power and measure the voltage between the Power L and Power N terminals 1 and 2) using an AC voltmeter. The reading should be between 108V and 132V AC

4.3.3 Testing the Outputs

4.3.3.1 System Circulator Pump (Sys Pmp)

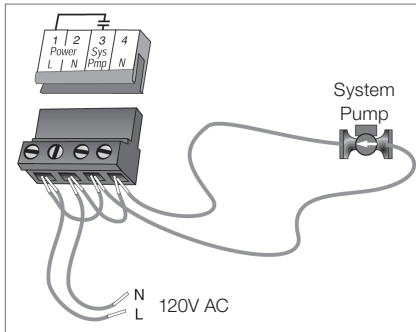

If a system circulator pump is connected to the Sys Pmp terminal (3) and N terminal (4), make sure that power to the terminal block is off and install a jumper between the Power L and the Sys Pmp terminals (1 and 3). Install a second jumper between the Power N and N terminals (2 and 4). When power is applied to the Power L and Power N terminals (1 and 2), the system circulator pump should start. If the circulator pump does not turn on, check the wiring between the terminal block and circulator pump and refer to any installation or troubleshooting information supplied with the circulator pump. If the pump operates properly, disconnect the power and remove the jumpers.

4.3.3.2 Boiler

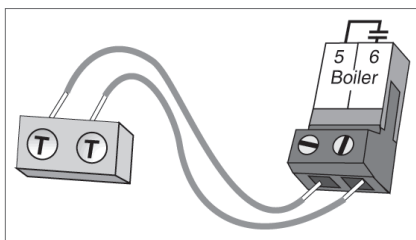

If the boiler is connected to the boiler terminals (5 and 6), make sure power to the boiler circuit is off and install a jumper between the terminals. When the boiler circuit is powered up, the boiler should fire. If the boiler does not turn on, refer to any installation or troubleshooting information supplied with the boiler. (The boiler may have a flow switch that prevents firing until the boiler pump is running.) If the boiler operates properly, disconnect the power and remove the jumper.

4.3.4 Connecting the Control

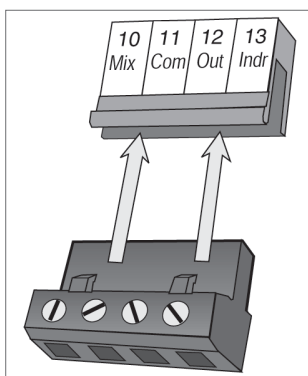

Make sure all power to the devices and terminal blocks is off and remove any remaining jumpers from the terminals.

Reconnect the terminal blocks to the control by carefully aligning them with their respective headers on the control and then pushing the terminal blocks into the headers. The terminal blocks should snap firmly into place.

Install the supplied safety dividers between the unpowered sensor inputs and the powered 120V AC or 24V AC wiring chambers.

Apply power to the control. The operation of the control on power up is described in section "3.3 Control Operation" on page 8.

4.3.4.1 Mixing or Injection Valve Actuator

If a floating action actuating motor circuit is connected to the R Opn, R Cls, and C terminals (7, 8, and 9), the control's Test Sequence can be used to check the motor circuit. Once the Test button is pressed, the valve should move to the fully open position. If the motor closes instead of opening, the wiring of the actuating motor must be reversed. Next, the actuator should move the valve to the fully closed position. If it does not, check the wiring between the terminals and the actuating motor. Refer to any installation or troubleshooting information supplied with the actuator.

4.4 DIP Switch Settings

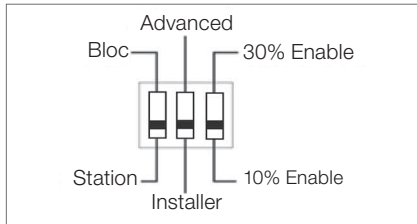

The DIP switch settings on the control are very important and should be set to the appropriate settings prior to making any adjustments to the control through the User Interface. The DIP switch settings change the items that are available to be viewed and/or adjusted in the User Interface.

4.4.1 Advanced/Installer

The Advanced/Installer DIP switch is used to select which items are available to be viewed and/or adjusted in the User Interface (see "4.5 View Menu Display Settings" on page 23).

4.4.2 Boiler Enable 30% - Boiler Enable 10%

The position of this switch determines at which valve position the control will close the boiler contact under normal conditions. Refer to section "3.8.2 Boiler Enable" on page 12) for a description of the Boiler Enable DIP.

4.4.3 Bloc / Station

The Bloc/Station switch is used to select which method the system will use to adjust supply water temperature. The Mixing Station, Enhanced Mixing Station, and Diverting Valves use the Three Position Actuator (Part Number 18003) with a 24V AC floating signal to adjust the water temperature. It takes 70 seconds for full valve travel. At 50 Hz, it takes 150 seconds to fully open from fully closed. At 60 Hz it takes 120 seconds to fully open from fully closed. If using Mixing Station, Enhanced Mixing Station and/or Diverting Valves, set DIP switch to "Station". If using Viega's 3 or 4 Way Mixing Valves with Viega's Mixing Valve Actuator or the ProBloc, set DIP switch to "Bloc". The Mixing Valve Actuator takes 102 seconds to fully open from fully closed.

4.5 View Menu Display Settings

Visible when the control is operating (no buttons pressed for at least 20 seconds).

4.5.1 OUTDR

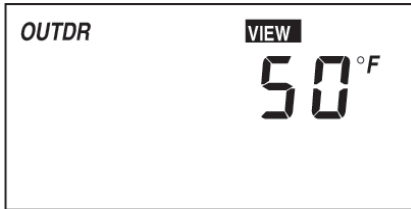

Current outdoor air temperature as measured by the outdoor sensor. This is also the default display for the control.

4.5.2 ROOM

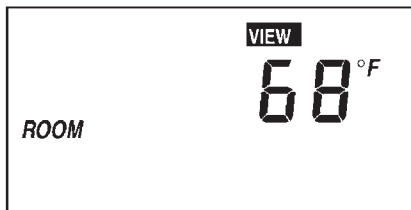

Measured room air temperature as measured by the indoor sensor. (Only visible when Indoor Sensor is connected).

4.5.3 MIX

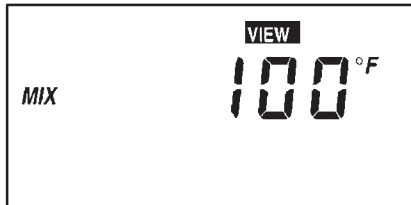

Current mixed supply water temperature as measured by the supply sensor.

4.5.4 MIX TARGET

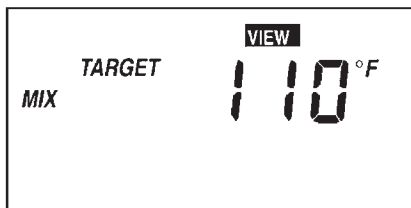

Target mixed supply is the temperature the control is currently trying to maintain at the supply sensor. (Only visible with the Advanced/Installer DIP switch set to Advanced).

4.6 Adjust Menu Display Settings

To make an adjustment to a setting in the control, press and hold simultaneously for 1 second, the Item, ▲ and ▼ buttons. The display will then show the word ADJUST in the top right corner. Then select the desired item using the Item button. Finally, use the ▲ and/or ▼ button to make the adjustment. See sections "3.6 Temperature Control Installer Information" on page 10 and "3.7 Temperature Control Advanced Information" on page 11 for further discussion on these items and their effect on control operation.

4.6.1 ROOM

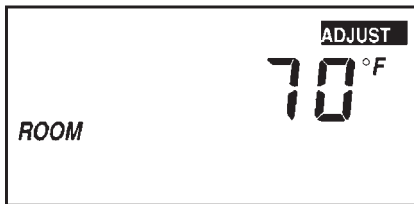

The desired room temperature.
Range: 35° F to 100° F

4.6.2 OUTDR DSGN

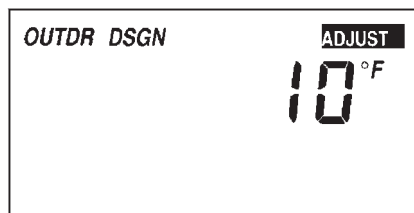

The design outdoor temperature used for calculating heat-loss. Obtained from the Design Outdoor Temperature Chart or Viega's Radiant Wizard*.
Range: -60° F to 32° F

4.6.3 MIX DSGN



The design supply water temperature obtained from the Supply Water Temperature / BTU Output Chart, or Viega's Radiant Wizard.
Range: 70° F to 220° F

4.6.4 MIX INDR

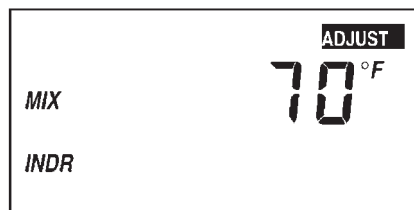

The design indoor air temperature used in the heat loss calculation* for the heating system (only visible with the Advanced/Installer DIP switch set to Advanced). Should be equal to "ROOM," the desired room temperature.
Range: 35° F to 150° F

* See corresponding installation manuals, i.e., Concrete System, Climate Panel, or Climate Trak for appropriate charts.

4.6.5 MIX MAX

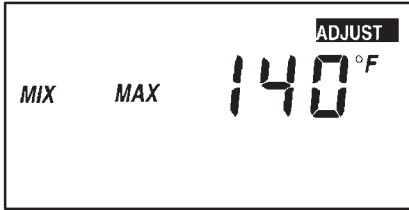

The maximum supply temperature for the mixing system (only visible with the Advanced/Installer DIP switch set to Advanced). This setting should not be relied upon for a safety high limit. Set higher than “MIX DSGN” and account for the heat loss of distribution piping.
Range: 80° F to 210° F or OFF

4.6.6 WWSD

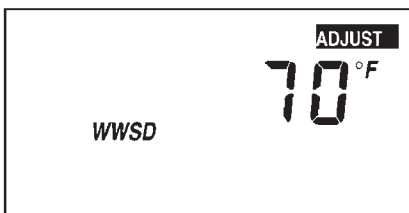

Warm Weather Shut Down; the design outdoor air temperature at which the control only operates in exercising mode (only visible with the Advanced/Installer DIP switch set to Advanced).
Range: 35° F to 100° F or OFF

4.6.7 UNITS



The units of measure that all of the temperatures are to be displayed in the control; either °F or °C.

4.7 Testing the Control

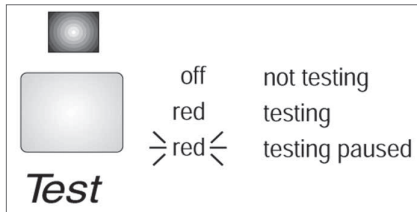

The Basic Heating Control has a built-in test routine that is used to test the main control functions. The Basic Heating Control continually monitors the sensors and displays an error message whenever a fault is found. See the following pages for a list of the Basic Heating Control's error messages and possible causes. When the Test button is pressed, the test light is turned on. The individual outputs and relays are tested in the following test sequence.

4.7.1 Test Sequence

Each step in the test sequence lasts 10 seconds.

During the test routine, the test sequence may be paused by pressing the Test button. If the Test button is not pressed again for 5 minutes while the test sequence is paused, the control exits the entire test routine. If the test sequence is paused, the Test button can be pressed again to advance to the next step. This can also be used to rapidly advance through the test sequence. To reach the desired step, repeatedly press and release the Test button until the appropriate device and segment in the display turn on.

4.7.2 Testing Sensors

A good quality test meter capable of measuring up to 5,000k Ω (1k Ω = 1000 Ω) is required to measure the sensor resistance. In addition to this, the actual temperature must be measured with a good quality digital thermometer. If a thermometer is not available, a second sensor can be placed alongside the one to be tested and the readings compared. First measure the temperature using the thermometer and then measure the resistance of the sensor at the control. The wires from the sensor must not be connected to the control while the test is performed. Using the chart below, estimate the temperature measured by the sensor.

The sensor and thermometer readings should be close. If the test meter reads a very high resistance, there may be a broken wire, a poor wiring connection, or a defective sensor. If the resistance is very low, the wiring may be shorted, there may be moisture in the sensor, or the sensor may be defective. To test for a defective sensor, measure the resistance directly at the sensor location.

Do not apply voltage to a sensor at any time as damage to the sensor may result.



If the reading is off by +/- 5% the sensor is bad and will need to be replaced.

| Temperature | | Resistance |
|-------------|-----|------------|
| °F | °C | Ω |
| -50 | -46 | 490,813 |
| -45 | -43 | 405,710 |
| -40 | -40 | 336,606 |
| -35 | -37 | 280,279 |
| -30 | -34 | 234,196 |
| -25 | -32 | 196,358 |
| -20 | -29 | 165,180 |
| -15 | -26 | 139,402 |
| -10 | -23 | 118,018 |
| -5 | -21 | 100,221 |
| 0 | -18 | 85,362 |
| 5 | -15 | 72,918 |
| 10 | -12 | 62,465 |
| 15 | -9 | 53,658 |
| 20 | -7 | 46,218 |
| 25 | -4 | 39,913 |
| 30 | -1 | 34,558 |
| 35 | 2 | 29,996 |
| 40 | 4 | 26,099 |
| 45 | 7 | 22,763 |
| 50 | 10 | 19,900 |
| 55 | 13 | 17,436 |
| 60 | 16 | 15,311 |
| 65 | 18 | 13,474 |
| 70 | 21 | 11,883 |
| 75 | 24 | 10,501 |
| 80 | 27 | 9,299 |
| 85 | 29 | 8,250 |

| Temperature | | Resistance |
|-------------|-----|------------|
| °F | °C | Ω |
| 90 | 32 | 7,334 |
| 95 | 35 | 6,532 |
| 100 | 38 | 5,828 |
| 105 | 41 | 5,210 |
| 110 | 43 | 4,665 |
| 115 | 46 | 4,184 |
| 120 | 49 | 3,760 |
| 125 | 52 | 3,383 |
| 130 | 54 | 3,050 |
| 135 | 57 | 2,754 |
| 140 | 60 | 2,490 |
| 145 | 63 | 2,255 |
| 150 | 66 | 2,045 |
| 155 | 68 | 1,857 |
| 160 | 71 | 1,689 |
| 165 | 74 | 1,538 |
| 170 | 77 | 1,403 |
| 175 | 79 | 1,281 |
| 180 | 82 | 1,172 |
| 185 | 85 | 1,073 |
| 190 | 88 | 983 |
| 195 | 91 | 903 |
| 200 | 93 | 829 |
| 205 | 96 | 763 |
| 210 | 99 | 703 |
| 215 | 102 | 648 |
| 220 | 104 | 598 |
| 225 | 107 | 553 |

Table 1: Sensor Resistance

5 Troubleshooting

When troubleshooting any heating system, it is always a good idea to establish a set routine to follow. By following a consistent routine, many hours of potential headaches can be avoided. Below is an example of a sequence that can be used when diagnosing or troubleshooting problems in a hydronic heating system.

Establish the problem. Get as much information from the customer as possible about the problem. Is there too much heat, not enough heat, or no heat? Is the problem only in one particular zone or area of the building or does the problem affect the entire system? Is this a consistent problem or only intermittent? How long has the problem existed? This information is critical in diagnosing the problem.

Understand the sequence of operation of the system. If a particular zone is not receiving enough heat, which circulators or valves in the system must operate in order to deliver heat to the affected zone? If the zone is receiving too much heat, which pumps, valves, or check valves must operate in order to stop the delivery of heat?

Press the Test button on the control and follow the control through the test sequence as described in the Testing section. Pause the control as necessary to ensure that the correct device is operating as it should.

Sketch the piping of the system. This is a relatively simple step that tends to be overlooked; however, it can often save hours of time in troubleshooting a system. Note flow directions in the system paying close attention to the location of circulator pumps, check valves, pressure bypass valves, and mixing valves. Ensure correct flow direction on all circulator pumps. This is also a very useful step if additional assistance is required.

Document the control for future reference. Before making any adjustments to the control, note all of the items that the control is currently displaying. This includes items such as error messages, current temperatures and settings, and which devices should be operating as indicated by the LCD. This information is an essential step if additional assistance is required to diagnose the problem.

Isolate the problem between the control and the system. Now that the sequence of operation is known and the system is sketched, is the control operating the proper circulator pumps and valves at the correct times? Is the control receiving the correct signals from the system as to when it should be operating? Are the proper items selected in the menus of the control for the device that is to be operated?

Test the contacts, voltages, and sensors. Using a multimeter, ensure that the control is receiving adequate voltage to the power terminals as noted in the technical data. Use the multimeter to determine if the internal contacts on the control are opening and closing correctly. Follow the instructions in section "4.3 Testing the Wiring" on page 20 to simulate closed contacts on the terminal blocks as required. Test the sensors as described in section "4.7.2 Testing Sensors" on page 26.

See below for what to do if the building temperature is incorrect.

5.1 Underheating

If the building is too cool during cold weather, this indicates that the upper portion of the programmed heating curve is too low, or that the supply water high limit (MIX MAX) has been reached. If the supply temperature is close to MIX MAX, then this setting must be increased to provide more heat (if possible without damaging floors). Otherwise increase the MIX DSGN temperature, which will increase the supply water temperature (by increasing the slope of the heating curve).

If the building is too cool in warm weather, increase the value of the ROOM setpoint in the Adjust menu. This will shift the heating curve up to provide higher water temperatures.

5.2 Overheating

If the building is too warm during cold weather, decrease the value of the MIX DSGN setting in the Adjust menu. This will reduce the slope of the heating curve, providing less heat to the building at low outdoor temperatures.

If the building is too warm during warmer weather, reduce the value of the ROOM setpoint in the adjust menu. This will shift the heating curve downward to reduce water temperatures.

5.3 Error Messages

5.3.1 E01

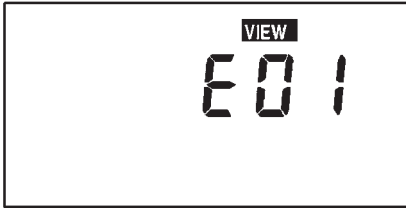

The control was unable to read a piece of information from its EEPROM. This error can be caused by a noisy power source. The control will load the factory defaults and stop operation until the settings are verified.

5.3.2 Shr (OUTDR)

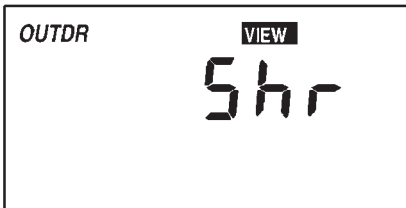

The control is no longer able to read the Outdoor sensor due to a short circuit. In this case the control assumes an outdoor temperature of 32° F (0° C) and continues operation. Locate the problem as described in Section 5.7. To clear the error message from the control after the sensor has been repaired, press the Item button.

5.3.3 OPn (OUTDR)

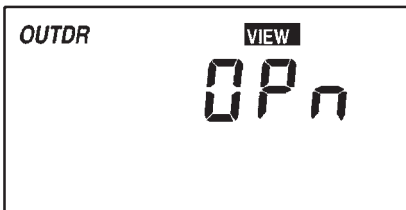

The control is no longer able to read the Outdoor sensor due to an open circuit. In this case the control assumes an outdoor temperature of 32° F (0° C) and continues operation. Locate the problem as described in Section 5.7. To clear the error message from the control after the sensor has been repaired, press the Item button.

5.3.4 Shr (MIX)

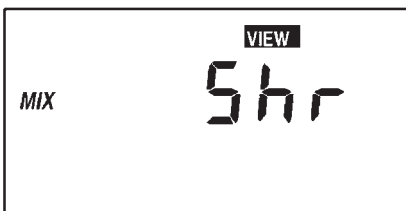

The control is no longer able to read the Mixing Supply sensor due to a short circuit. In this case the control will operate the mixing valve at a fixed output. Locate the problem as described in Section 5.7. To clear the error message from the control after the sensor has been repaired, press the Item button.

5.3.5 OPn (MIX)

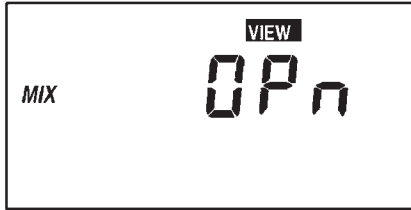

The control is no longer able to read the Mixing Supply sensor due to an open circuit. In this case the control will operate the mixing valve at a fixed output. Locate the problem as described in Section 5.7. To clear the error message from the control after the sensor has been repaired, press the Item button.

5.3.6 Shr (ROOM)

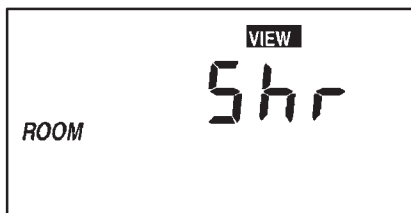

The control is no longer able to read the Indoor sensor due to a short circuit. The control will continue to operate as if there was nothing connected to the Indoor sensor input. Locate the problem as described in Section 5.7. To clear the error message from the control after the sensor has been repaired, press the Item button.

5.3.7 OPn (ROOM)

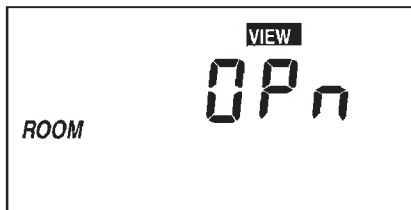

The control is no longer able to read the Indoor sensor due to an open circuit. The control will continue to operate as if there was nothing connected to the Indoor sensor input. Locate the problem as described in Section 5.7. To clear the error message from the control after the sensor has been repaired, press the Item button.

6 Mechanical and Electrical Diagrams

6.1 Mechanical Schematic

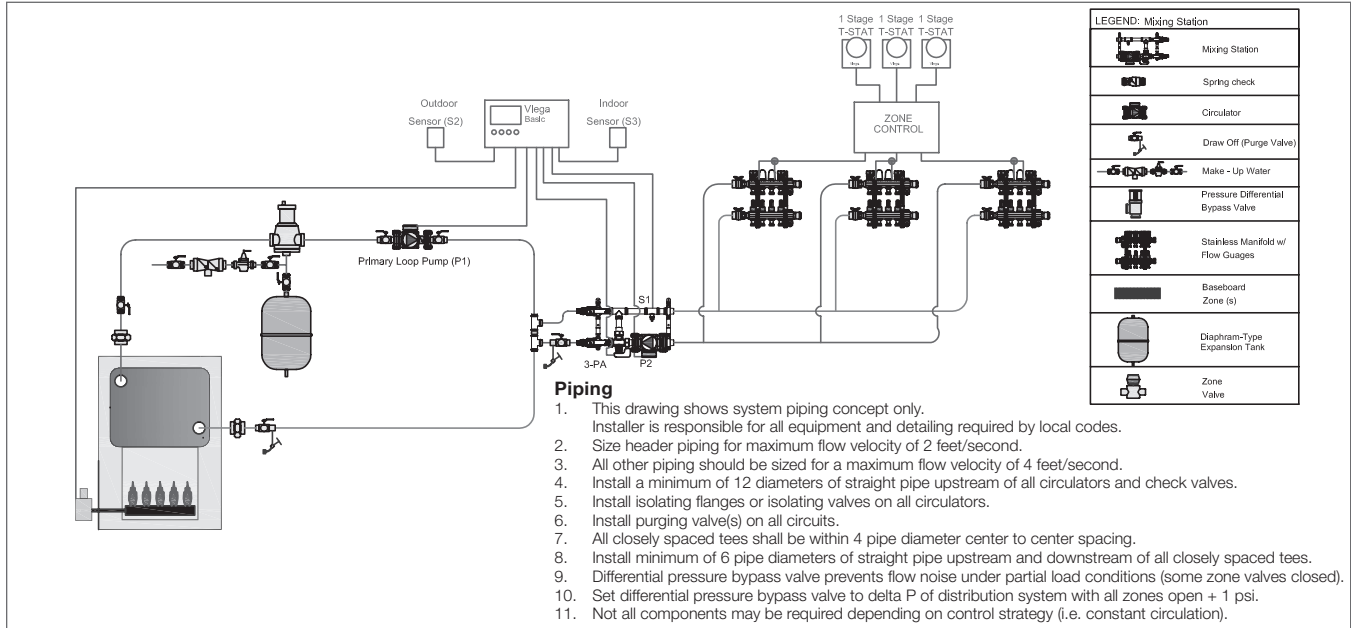

6.2 Electrical Schematic

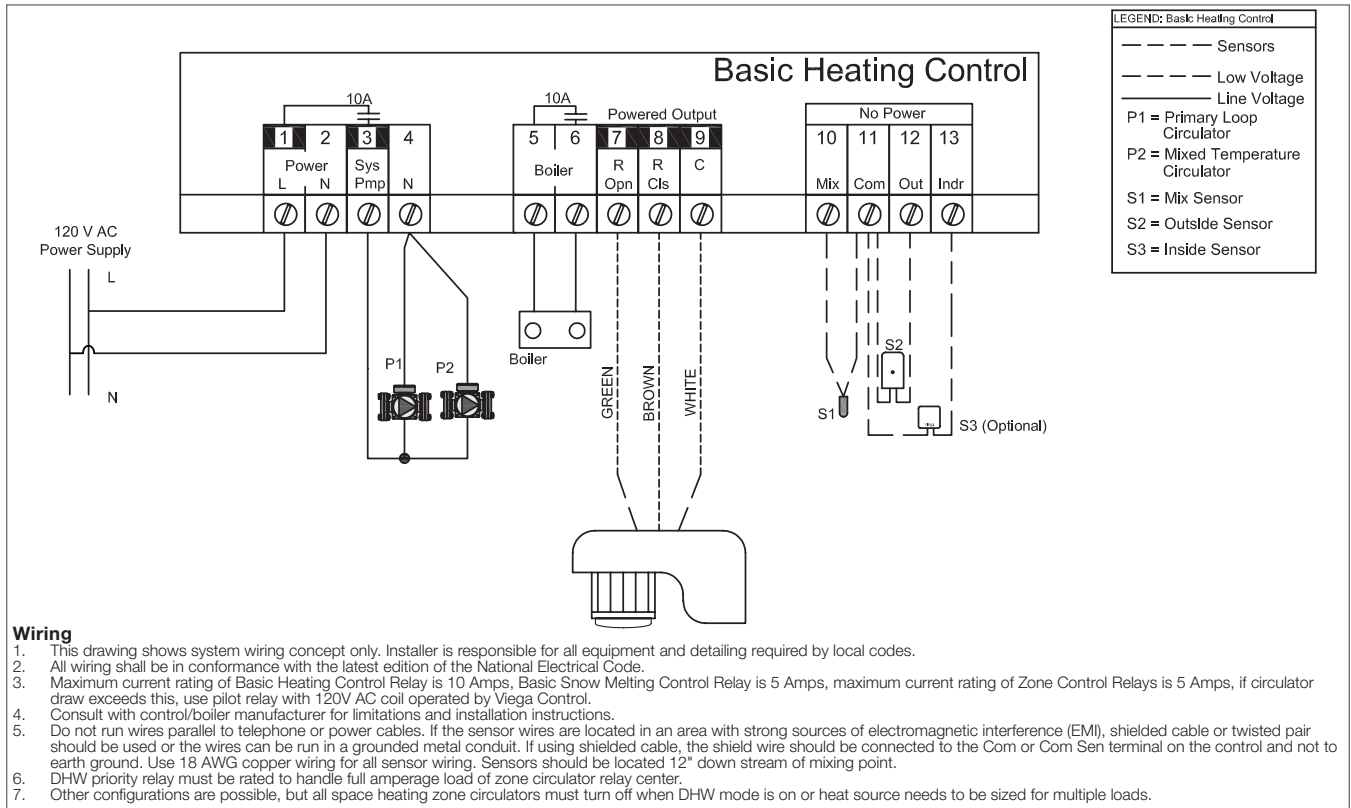

7 Technical Data

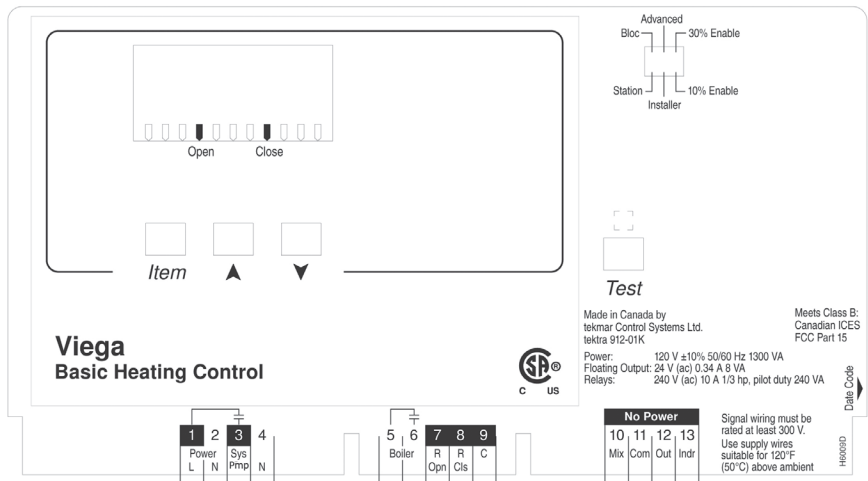

- Control: Microprocessor PID control; this is not a safety (limit) control
- Packaged Weight: 3.1 lbs. (1420 g) enclosure black PVC plastic
- Dimensions: 6-5/8" H x 7-9/16" W x 2-13/16" D (170 x 193 x 72 mm)
- Approvals: CSA C US, meets ICES & FCC regulations for EMI/RFI
- Ambient Conditions: Indoor use only, 32 to 102° F (0 to 39° C), <90% RH non-condensing
- Power Supply: 120V AC +/- 10% 50/60 Hz 1300 VA
- Floating Output: 24V AC 0.34 A 8 VA
- Relays: 240V AC 10 A 1/3 hp, pilot duty 240 VA
- Sensors: NTC thermistor

8 Limited Warranty

8.1 Limited Warranty for Viega Heating and Cooling Solutions

Hydronic Radiant Heating/Cooling and Snow Melt

Subject to the conditions and limitations in this Limited Warranty, Viega LLC (Viega) warrants to property owners in the United States with hydronic radiant heating/cooling and/or snow melt systems (the systems) properly installed by Viega trained contractors that its Viega Barrier PEX and FostaPEX® tubing, under normal conditions of use and properly maintained, will be free from failure caused by manufacturing defect for a period of thirty (30) years from date of installation.

In addition, Viega warrants that Viega PEX press metal and polymer fittings properly installed in the systems with the above listed tubing, to include protected PEX press metal and polymer fittings used in slab, will be free from failure caused by manufacturing defect for a period of thirty (30) years from date of initial installation; warrants that any accessible metal compression or metal/polyalloy crimp fittings, manifolds and panels sold by Viega and used in the systems will be free from failure caused by manufacturing defect for a period of five (5) years, and warrants that any controls, mixing stations, or electrical components sold by Viega and used in the systems will be free from failure caused by manufacturing defect for a period of two (2) years from date of initial installation.

Power tools and jaws used with press fittings are warranted by the manufacturer and Viega extends no separate warranty on those tools or jaws. Viega warrants that PEX press hand and pneumatic PEX hammer tools sold by Viega, under normal conditions of use, shall be free from failure caused by manufacturing defects for a period of two (2) years from date of sale.

Under this limited warranty, you only have a right to reimbursement if the failure or leak resulted from a manufacturing defect in the products covered by this warranty and the failure or leak occurred during the warranty period. You do not have a remedy or right of reimbursement under this warranty and the warranty does not apply if the failure or any resulting damage is caused by (1) components in the systems other than those manufactured or sold by Viega or components not recommended for use in the systems (2) not installing, inspecting, or testing the products covered by this warranty in accordance with Viega's installation instructions at the time of the installation, applicable code requirements and accepted industry practices (for example, guidelines of the Radiant Professionals Alliance); (3) improper design, including determining proper heat-load of the system, or improper maintenance of the system; (4) exposure to unauthorized solvents or chemicals, antifreeze, rust inhibitor or other treatment fluids; freezing; or by failure to appropriately limit recommended water temperature levels or other misuse or abuse of the

tubing in the handling of the tubing prior to or during installation or by other construction activity on the property; (5) acts of nature such as earthquakes, fire, flood, wind, or lightning.

In the event of a leak or other failure in the system, it is the responsibility of the property owner to obtain and pay for the repairs. Only if the warranty applies will Viega be responsible for reimbursement under this warranty. The part or parts which you claim failed should be kept and Viega contacted by writing to the address below or telephoning 1-800-976-9819 within thirty (30) days after the leak or other failure and identifying yourself as having a warranty claim. You should be prepared to ship, at your expense, the product which you claim failed due to a manufacturing defect, document the date of installation, and the amount of any claimed bills for which you claim reimbursement. Within a reasonable time after notification, Viega will investigate the reasons for the failure, which includes the right to inspect the product at Viega and reasonable access to the site of the damage in order to determine whether the warranty applies. Viega will notify you in writing of the results of its review.

In the event that Viega determines that the failure or leak and any resulting damages were the result of a manufacturing defect in the products covered by this warranty and occurred during the first ten years of the time period covered by this warranty, Viega will reimburse the property owner for reasonable repair or replacement charges resulting from the failure or leak and, additionally will reimburse damages to personal property resulting from the failure or leak. After the first ten years of the time period covered by this warranty, the EXCLUSIVE and ONLY remedy will be reimbursement for repair and replacement of the product covered by this warranty. VIEGA SHALL NOT BE LIABLE FOR CONSEQUENTIAL ECONOMIC LOSS DAMAGES UNDER ANY LEGAL THEORY AND WHETHER ASSERTED BY DIRECT ACTION, FOR CONTRIBUTION OR INDEMNITY OR OTHERWISE.

THE ABOVE LIMITED WARRANTY IS IN LIEU OF ALL OTHER WARRANTIES, EXPRESS OR IMPLIED, INCLUDING BUT NOT LIMITED TO, THE IMPLIED WARRANTIES OF MERCHANTABILITY AND FITNESS FOR A PARTICULAR PURPOSE. IF FOUND APPLICABLE, ANY IMPLIED WARRANTIES ARE LIMITED TO THE DURATION OF ANY TIME LIMITS SET OUT IN THIS WRITTEN WARRANTY. Other than this limited warranty, Viega does not authorize any person or firm to create for it any other obligation or liability in connection with its products. This written warranty applies for the full term of the applicable warranty regardless of any change of ownership of the property.

In the event that the tubing or fittings covered by this warranty are used in potable water plumbing systems, the Viega Limited Warranty for Viega PEX Water Systems will apply.

Some states do not allow the exclusion or limitation of incidental or consequential damages or limitations on the duration of implied warranties in certain types of transactions, so the above exclusion or limitations may not apply to you. This limited warranty gives you specific legal rights and you also may have other rights which vary from state to state. This warranty shall be interpreted and applied under the law of the state in which the product is installed.

> Viega LLC
585 Interlocken Blvd.
Broomfield, CO 80021

Phone (800) 976-9819
www.viega.us

IM-HC 561174 1120 Basic Heating Control

©2020, Viega®, FostaPEX®, GeoFusion®, ManaBloc®, MegaPress®, ProPress®, SeaPress®, Smart Connect®, Climate Mat®, Climate Panel®, Climate Trak®, PureFlow®, XL®, XL-C®, Visign®, Visign for Style®, Visign for More®, Visign for Care®, Visign for Public®, Viega Eco Plus®, and Viega: Connected in quality® are trademarks of Viega Holding GmbH & Co. KG. Eco Brass® is a registered trademark of Mitsubishi Shindoh Co., LTD. RIDGID® is a registered trademark of RIDGID, Inc. LoopCAD® is a registered trademark of Avenir Software Inc. Radel® R is a registered trademark of Solvay Advanced Polymers, LLC. LEED® is a registered trademark of the U.S. Green Building Council®.

