

APPLICATIONS ENGINEERING

# Vitodens 100-W B1HE/B1KE **APPLICATION GUIDE**

**B1HE Series and B1KE Combi Series**  
**Wall mounted gas-fired condensing boiler**  
**85 to 199 MBH**



# Component Index

## Hydronic Components

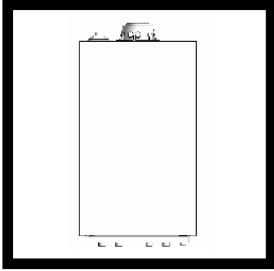

Boiler

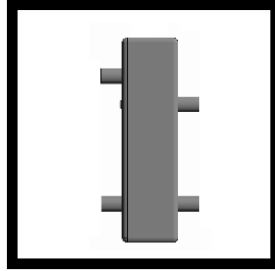

Low Loss Header

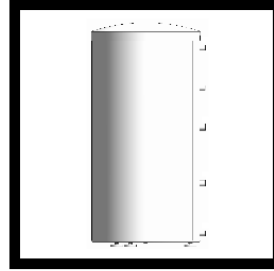

DHW Indirect Tank

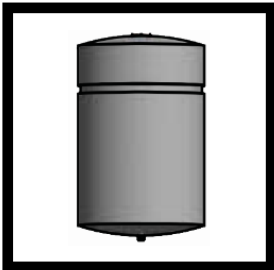

Expansion Tank

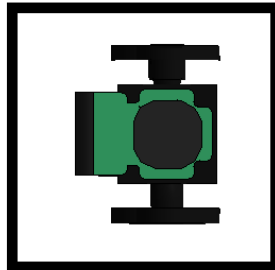

Circulator

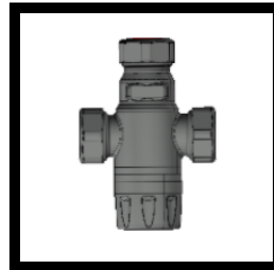

Thermostatic Mixing Valve

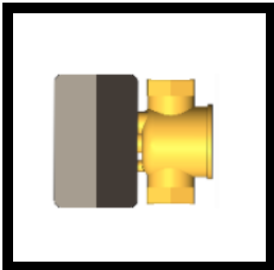

Zone Valve



Balancing Valve

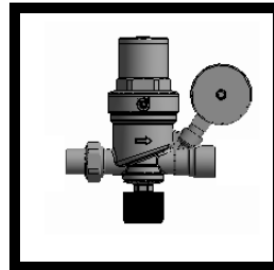

Fill Valve



Backflow Preventer



Air Separator

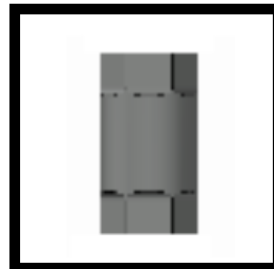

Check Valve

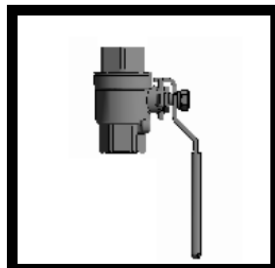

Ball Valve

## Electrical Components

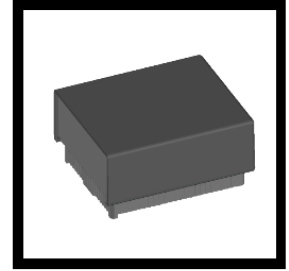

Outdoor Air Sensor

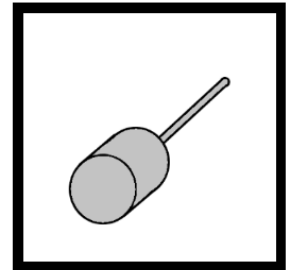

DHW Sensor

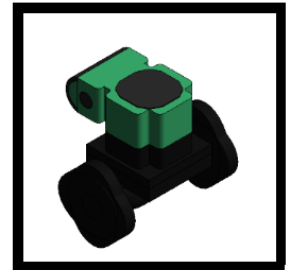

Circulator



Thermostat

# Index

## General

Component Index.....	2
Boiler Overview.....	4
Boiler Dimensions.....	7
Boiler Piping Connections.....	9
Boiler Minimum Clearances.....	11

## Boiler Applications

### B1HE

One Boiler, Single Temperature with a single Heating Circuit and DHW.....	12
One Boiler, Single Temperature with three Heating Circuits and DHW.....	14
One Boiler, Single Temperature with three Zone Valves and DHW.....	16
One Boiler, Multiple Temperatures with one Mixing Valve and DHW.....	18
One Boiler, Single Temperature with DHW on System Side.....	20

### B1KE

One Boiler, Single Temperature with a single Heating Circuit and DHW.....	22
One Boiler, Single Temperature with three Heating Circuits and DHW.....	24
One Boiler, Single Temperature with three Zone Valves and DHW.....	26
One Boiler, Multiple Temperatures with one Mixing Valve and DHW.....	28

## General

Gas Line Sizing Chart.....	30
Miscellaneous Links.....	31

## General Information

### Boiler Overview

← Back to Index

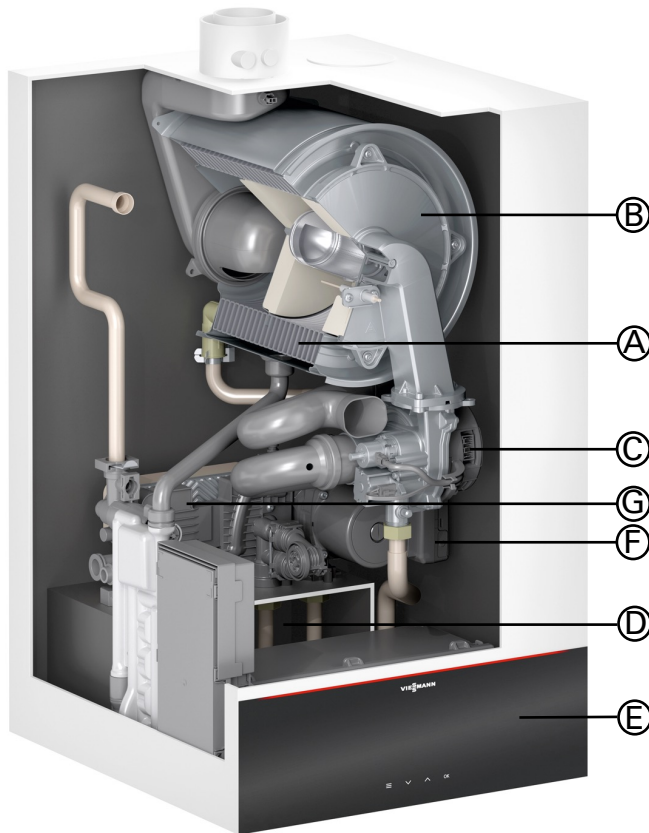

The B1HE and B1KE boilers are high efficiency, gas-fired condensing boilers with pre-mix modulating cylinder burners for natural gas (NG) or liquid propane (LP), with Inox-Radial heat exchanger made of high-grade stainless steel.

The B1HE 85-120 and B1KE-120 is designed for closed loop hot water heating systems with maximum supply water temperatures of 180°F for a maximum operating pressure of 45psig.

The B1HE 150-199 and B1KE-199 is designed for closed loop hot water heating systems with maximum supply water temperatures of 180°F for a maximum operating pressure of 60psig.

The pre-mix cylinder burners have an environmentally - friendly operation with a modulation range of to 10:1.

- (A) Inox-Radial stainless steel heat exchanger
- (B) Stainless steel MatrixPlus cylinder burner
- (C) Burner blower
- (D) Gas and hydronic connections
- (E) Black and white 3.5 inch boiler control display
- (F) High efficiency boiler/DHW production pump
- (G) DHW plate heat exchange (combi boilers only)

# General Information

## Boiler Overview (Continued)

[← Back to Index](#)

### Standard heating boiler

	Boiler Model No.	B1HE-85	B1HE-120	B1HE-150	B1HE-199	B1KE-120	B1KE-199
CSA input Natural gas (NG)	MBH	8.5-85	12-120	15.5-150	19.9-199	12-120	19.9-199
	kW	2.5-24.9	3.5-35.2	4.5-44.0	5.8-58.3	3.5-35.2	5.8-58.3
CSA input Liquid propane Gas (LPG)	MBH	14-85	14-120	22.7-150	22.7-199	14-120	22.7-199
	kW	4.1-24.9	4.1-35.2	6.7-44.0	6.7-58.3	4.1-35.2	6.7-58.3
CSA output/DOE *1	MBH	8-80	11-113	14-141	18.5-187	11-113	18.5-187
heating capacity NG	kW	2.3-23.4	3.2-33.1	4.1-41.3	5.4-54.8	3.2-33.1	5.4-54.8
CSA output/DOE *1	MBH	13-80	13-113	21-141	21-187	13-113	21-187
heating capacity LPG	kW	3.8-23.4	3.8-33.1	6.1-41.3	6.1-54.8	3.8-33.1	6.1-54.8
Net AHRI rating *2	MBH	70	98	123	163	98	163
	kW	20.5	28.7	36.0	47.8	28.7	47.8
Heat exchanger surface area	ft. <sup>2</sup>	12.96	12.96	27.44	27.44	12.96	27.44
	m <sup>2</sup>	1.20	1.20	2.55	2.55	1.20	2.55
Min. gas supply pressure							
Natural gas	"w.c.	4	4	4	4	4	4
LPG	"w.c.	10	10	10	10	10	10
Max. gas supply pressure *3							
Natural gas and LPG	"w.c.	14	14	14	14	14	14
A.F.U.E.	%	95	95	95	95	95	95
Weight	lbs	108	108	179	179	110	190
	kg	49	49	81	81	50	86
Shipping weight	lbs	143	143	218	218	146	229
	kg	65	65	99	99	66	104
Boiler water content	USG	1.02	1.02	2.5	2.5	1.02	2.5
	L	3.88	3.88	9.50	9.50	3.88	9.50
Boiler max. flow rate *4	GPM	4.8	6.2	8.8	10.6	6.2	10.6
	L/h	1090	1408	1999	2408	1408	1408
Max. operating pressure (max. allowable working pressure) at 210°F (99°C)	psig bar	45 3	45 3	60 4	60 4	45 3	60 4
Boiler water temperature							
- Adjustable high limit (AHL) range							
- space heating (steady state)	°F (°C)			68-180 (20-82)			
- DHW tank heating	°F (°C)			194 (90)			
- DHW heating	°F (°C)			194 (90)			
- Fixed high limit (FHL)	°F (°C)			210 (99)			
Boiler connections							
Boiler heating supply and return	NPTM (male)	¾ in	¾ in	1 in	1 in	¾ in	1 in
Pressure relief valve	NPTF (female)	¾ in	¾ in	¾ in	¾ in	¾ in	¾ in
DHW tank heating supply/return	NPTM (male)	¾ in	¾ in	1 in	1 in	-	-
DHW heating	NPTM (male)	-	-	-	-	¾ in	1 in
Drain valve	(male thread)	¾ in	¾ in	¾ in	¾ in	¾ in	¾ in
Dimensions							
Overall depth	inches	19 ¾	19 ¾	21 ¾	21 ¾	19 ¾	21 ¾
	(mm)	(500)	(500)	(550)	(550)	(500)	(550)
Overall width	inches	17 ¾	17 ¾	17 ¾	17 ¾	17 ¾	17 ¾
	(mm)	(450)	(450)	(450)	(450)	(450)	(450)
Overall height	inches	33 ¾	33 ¾	39	39	33 ¾	39
	(mm)	(859)	(859)	(989)	(989)	(859)	(989)

\*1 Output based on 140°F (60°C), 120°F (49°C) system supply / return temperature.

\*2 Net AHRI rating based on piping and pick-up allowance of 1.15.

\*3 If the gas supply pressure exceeds the maximum gas supply pressure value, a separate gas pressure regulator must be installed upstream of the heating system.

\*4 See "System Flow Rates" on page 11 in this manual.

# General Information

## Boiler Overview (Continued)

[← Back to Index](#)

### Standard heating boiler (continued)

	Boiler Model No.	B1HE-85	B1HE-120	B1HE-150	B1HE-199	B1KE-120	B1KE-199
<b>Gas supply connection</b>	NPTM (male)	¾ in	¾ in	¾ in	¾ in	¾ in	¾ in
<b>Flue gas *5</b>							
Temperature at boiler return temperature of 86°F (30°C)							
- at rated full load	°F (°C)	99 (37)	102 (39)	106 (41)	104 (40)	102 (39)	104 (40)
- at rated partial load	°F (°C)	95 (35)	95 (35)	111 (44)	113 (45)	95 (35)	113 (45)
Temperature at boiler return temperature of 140°F (60°C)	°F (°C)	144 (62)	145 (63)	151 (66)	149 (65)	145 (63)	149 (65)
<b>Flue gas value</b>							
Mass flow rate (of flue gas)							
- at rated full load	lbs/h	86.9	126.0	155.9	207.0	147.0	207.0
	kg/h	39.4	57.1	70.7	93.9	66.7	93.9
- at rated partial load	lbs/h	8.9	13.0	16.1	20.8	13.0	20.8
	kg/h	4.0	5.9	7.3	9.4	5.9	9.4
Available draught	Pa	250	250	250	250	114	250
	mbar	2.5	2.5	2.5	2.5	1.14	2.5
<b>Flue gas temperature sensor limit</b>	°F (°C)	230 (110)	230 (110)	230 (110)	230 (110)	230 (110)	230 (110)
<b>Average condensate flow rate *6</b>							
with natural gas							
- $T_s/T_R = 122 / 86^\circ\text{F}$ (50 / 30°C)	USG/day	20.3	27.9	34.9	46.9	27.9	46.9
	L/day	76.8	105.6	132.0	177.6	124.8	196.8
<b>Condensate connection *7</b>	hose nozzle Ø in	¾ in	¾ in	¾ in	¾ in	¾ in	¾ in
<b>Boiler flue gas connection *8</b>	Ø in (mm)	3 (80)	3 (80)	3 (80)	3 (80)	3 (80)	3 (80)
<b>Combustion air supply connection *8</b>	coaxial outer Ø in (mm)	5 (125)	5 (125)	5 (125)	5 (125)	5 (125)	5 (125)
	single Ø in (mm)	3 (80)	3 (80)	3 (80)	3 (80)	3 (80)	3 (80)
<b>Noise level (at 1 meter)</b>							
- at full load	(dB)	52	59	51	55	59	55
- at partial load	(dB)	34	34	31	31	34	31
NOx @ 3% O <sub>2</sub> *9		< 20 ppm					

\*5 Measured flue gas temperature with a combustion air temperature of 68°F (20°C).

\*6 Based on typical boiler cycles, including partial load conditions.

\*7 Requires ¾ in. (19 mm) tubing. See Vitodens 100-W Installation Instructions for details.

\*8 For detailed information refer to the Vitodens Venting System Installation Instructions.

\*9 The Vitodens 100 B1HE/B1KE boilers are certified to the requirements of South Coast Air Quality Management District (SCAQMD) Rule 1146.2, Bay Area Air Quality Management District (BAAQMD) Regulation 9 Rule 6, and San Joaquin Valley Air Pollution Control District (SJVAPCD) Rule 4308.

### B1KE on demand hot water operation

	Boiler Model No.	B1KE-120	B1KE-199
<b>Max. input NG and LPG</b> (DHW production only)	MBH kW	140 41.0	199 58.3
<b>Max. boiler temperature</b> (during DHW production)	°F (°C)	194 (90)	194 (90)
<b>DHW supply temperature</b>	°F (°C)	140 (60)	140 (60)
<b>Continuous draw rate *7</b> at $\Delta t = 77^\circ\text{F}$ (43K)	USG/min. (L/h)	3.3 757	4.7 1070
<b>Max. flow through heat exchanger</b>	USG/min. (L/h)	3.7 (840)	5.3 (1200)
<b>Maximum allowable working pressure</b> (potable water)	psi	150	150
<b>Test pressure</b>	psi	300	300

\*7 DCW and DHW temperature rise would be proportional. Maximum DHW supply temperature is 140°F (60°C).

## Boiler Dimensions – Models 100-W 85/120

← Back to Index

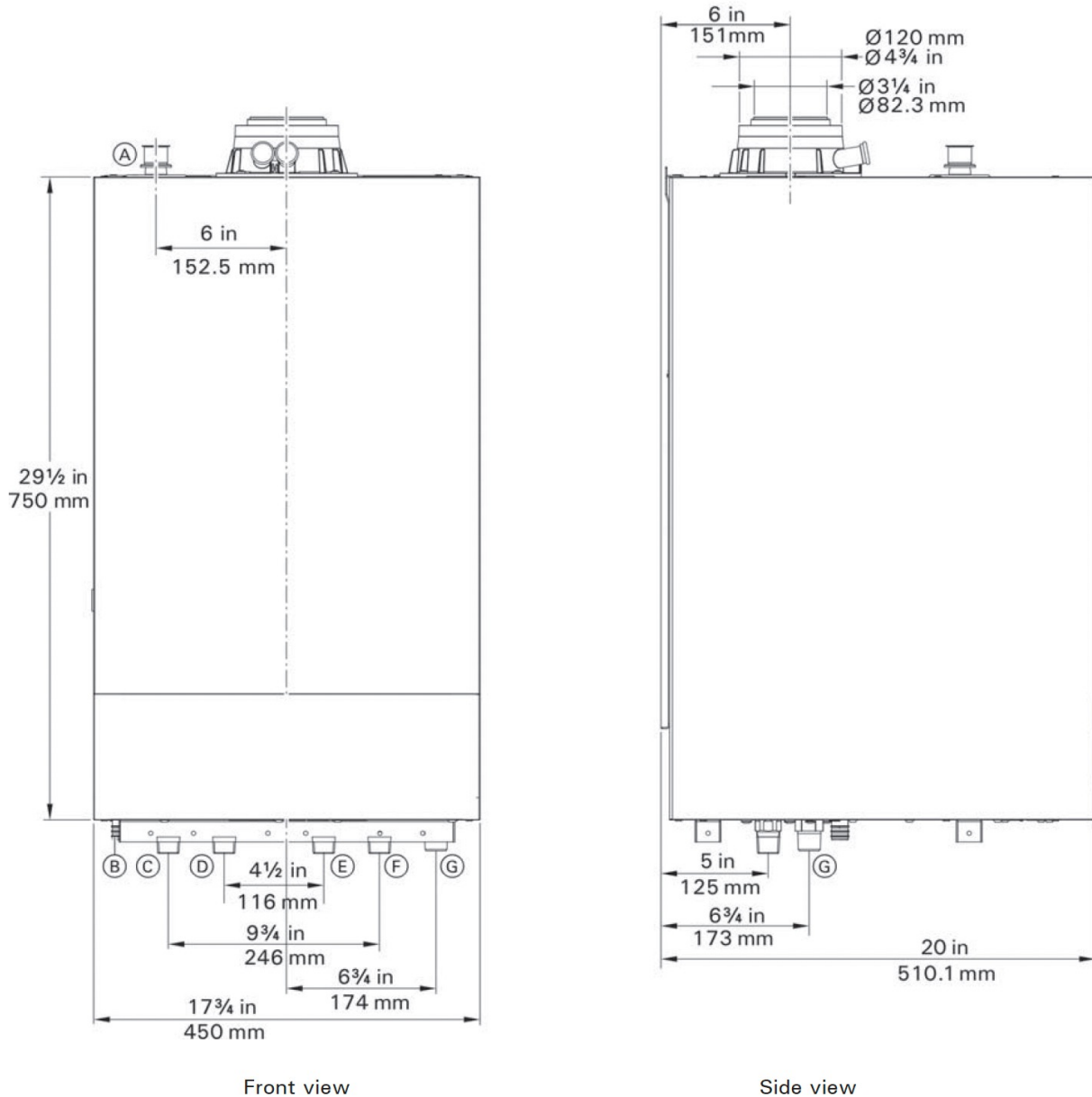

Front view

Side view

- Ⓐ Safety valve, pressure gauge connection
- Ⓑ Condensate drain
- Ⓒ Heating system supply
- Ⓓ For B1HE series, DHW tank heating supply  
For B1KE series, DHW
- Ⓔ For B1HE series, DHW tank heating return  
For B1KE series, DCW
- Ⓕ Heating system return
- Ⓖ Fuel gas connection

# Boiler Dimensions – Models 100-W 150/199

[← Back to Index](#)

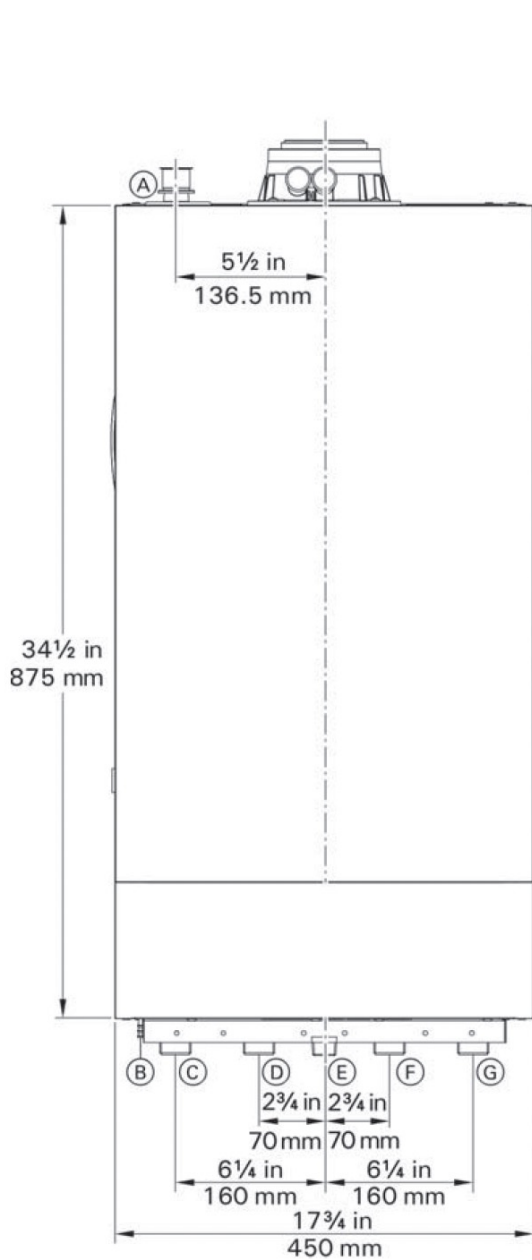

Front view

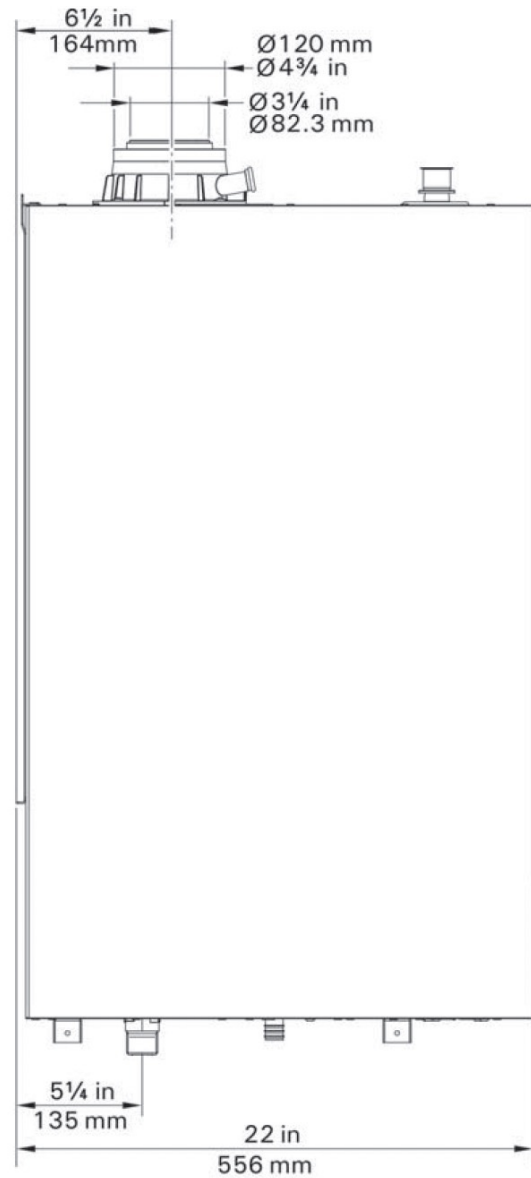

Side view

- (A) Safety valve, pressure gauge connection
- (B) Condensate drain
- (C) Heating system supply
- (D) For B1HE series, DHW tank heating supply  
For B1KE series, DHW
- (E) For B1HE series, DHW tank heating return  
For B1KE series, DCW
- (F) Heating system return
- (G) Fuel gas connection



## Boiler Piping Connections

[← Back to Index](#)

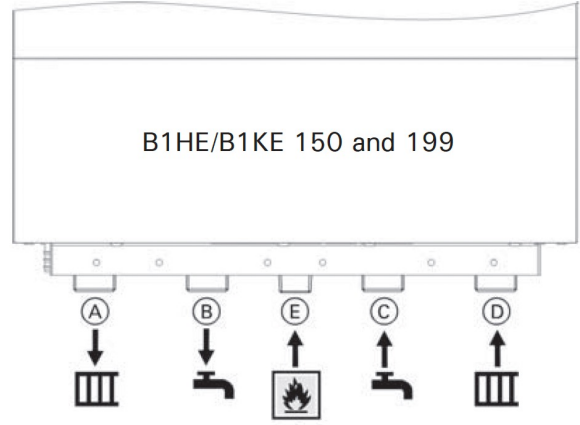
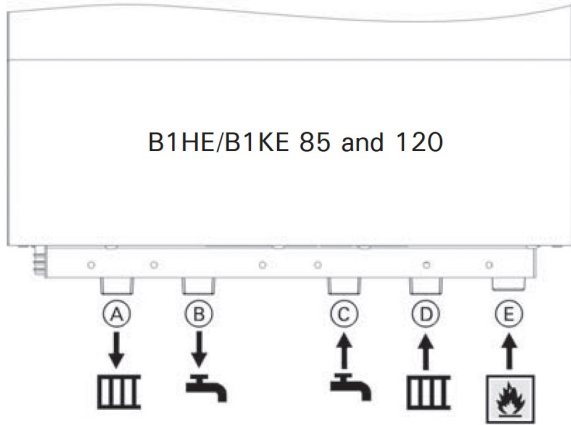

- Ⓐ Heating system supply  
B1HE/B1KE 85, 120 3/4 in. NPT  
B1HE/B1KE 150, 199 1 in. NPT
- Ⓑ Tank heating supply (B1HE)/DHW (B1KE)  
B1HE/B1KE 85, 120 3/4 in. NPT  
B1HE/B1KE 150, 199 1 in. NPT
- Ⓒ Tank heating return (B1HE)/DCW (B1KE)  
B1HE/B1KE 85, 120 3/4 in. NPT  
B1HE/B1KE 150, 199 1 in. NPT
- Ⓓ Heating system return  
B1HE/B1KE 85, 120 3/4 in. NPT  
B1HE/B1KE 150, 199 1 in. NPT
- Ⓔ Gas connection NPT 3/4 in. (male thread)

# Boiler Piping Connections

← Back to Index

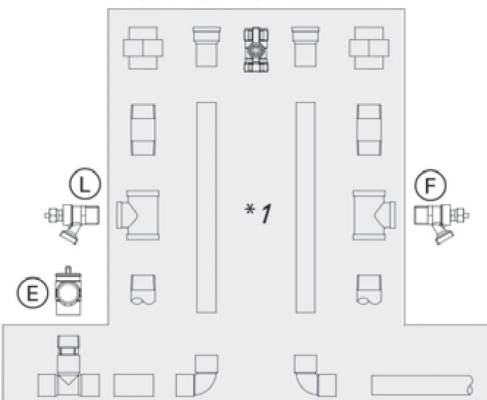
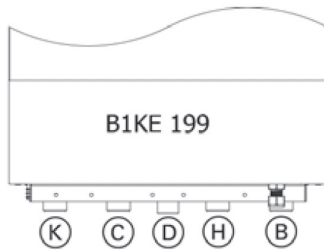
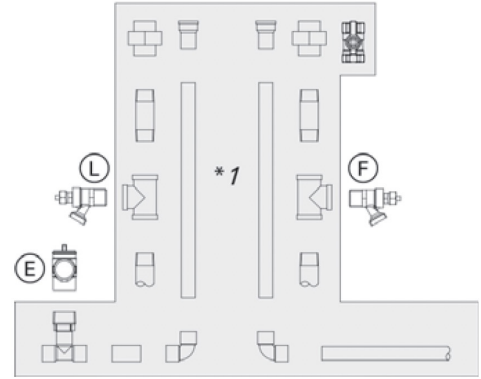
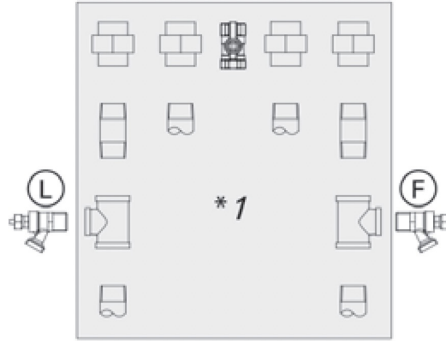
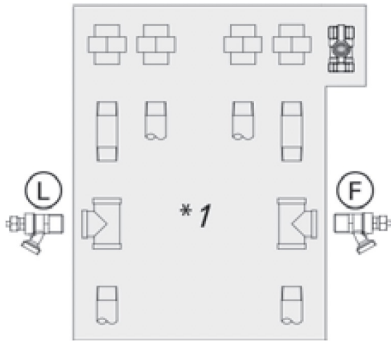
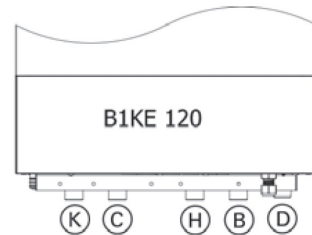
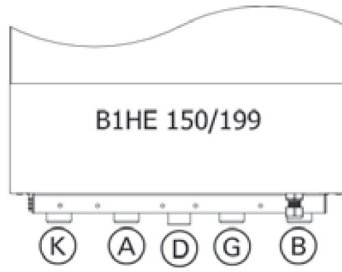
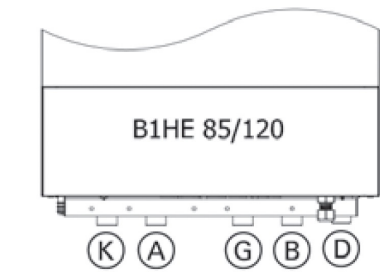

- (A) Tank heating supply
- (B) Heating system return
- (C) DHW (B1KE only)
- (D) Gas connection
- (E) 15 psi DHW pressure release valve (B1KE only)
- (F) Filling valve
- (G) Tank heating return
- (H) Connection cold water (B1KE only)
- (K) Heating system supply
- (L) Drain valve

\*1 Field supplied components

# Boiler Minimum Clearances

← Back to Index

## Recommended minimum boiler service clearances

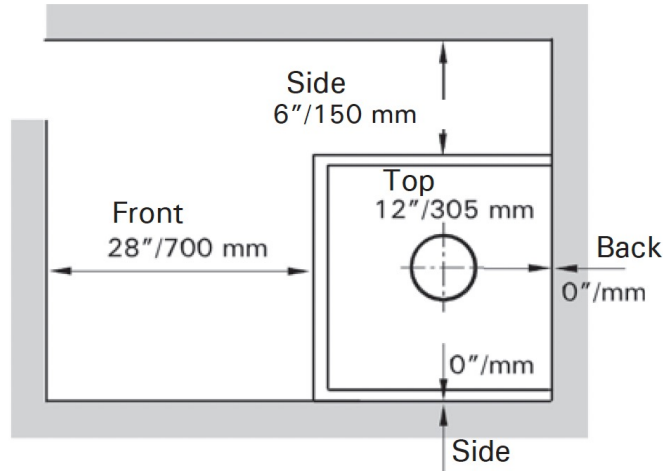

## Clearance to combustibles

Top	Front	Rear	Left	Right	Vent pipe * 1
0	0AL, CL	0	0	0	0

\* 1 Refer to the Installation Instructions of the Vitodens Venting System for details.

AL = Alcove

CL = Closet

## Recommended minimum boiler clearances to combustibles

**Note:** The Vitodens 100-W boiler has passed the zero inches vent clearance to combustibles testing requirements dictated by the boiler Harmonized Standard ANSI Z21.13. CSA 4.9 (latest edition) and therefore is listed for zero clearance to combustibles when vented with a single-wall special venting system (AL-29-4C material) or UL/ULC-listed CPVC gas vent material. The zero inches vent clearance to combustibles for the Vitodens 100-W boiler supercedes the clearance to combustibles listing that appears on the special venting system label.

Top clearance - 12" (30 cm).



See the Vitodens Venting System Installation Instructions.

# Vitodens 100-W

# Application 1

## Primary secondary

One Boiler, Single Temperature with a single Heating Circuit and DHW

[← Back to Index](#)

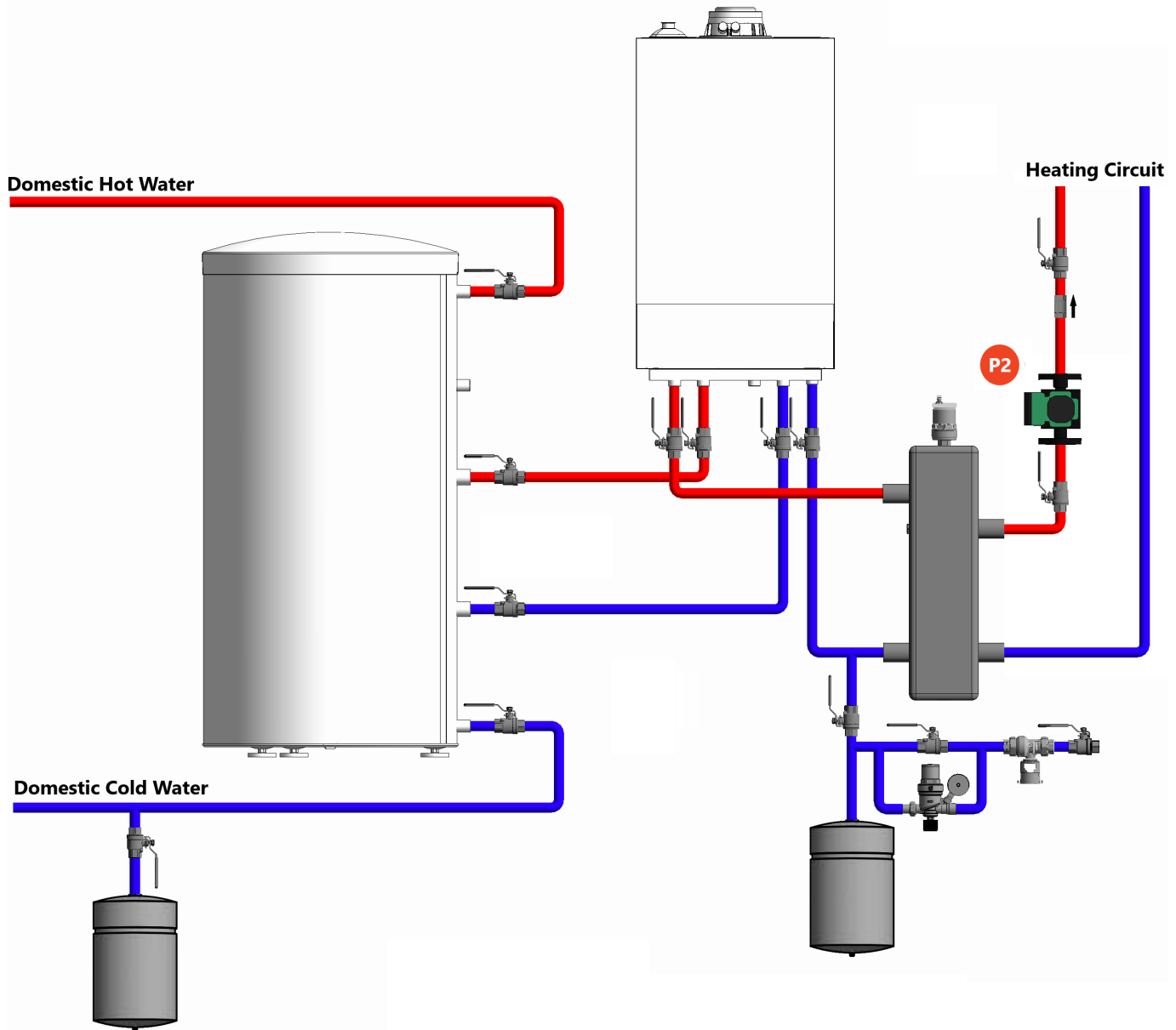

### Closely Spaced Tees

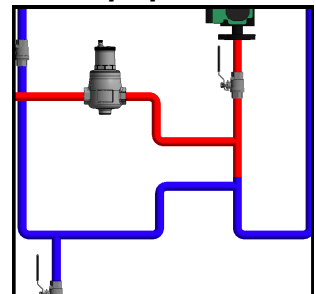

**Disclaimer:** Tempering Valves are field supplied where required by local jurisdiction.

**Disclaimer:** Refer to Installation Instructions for boiler connections when installing Viessmann Boilers, these are conceptual drawings.

# Vitodens 100-W

# Application 1

[← Back to Index](#)

## Primary secondary

One Boiler, Single Temperature with a single Heating Circuit and DHW

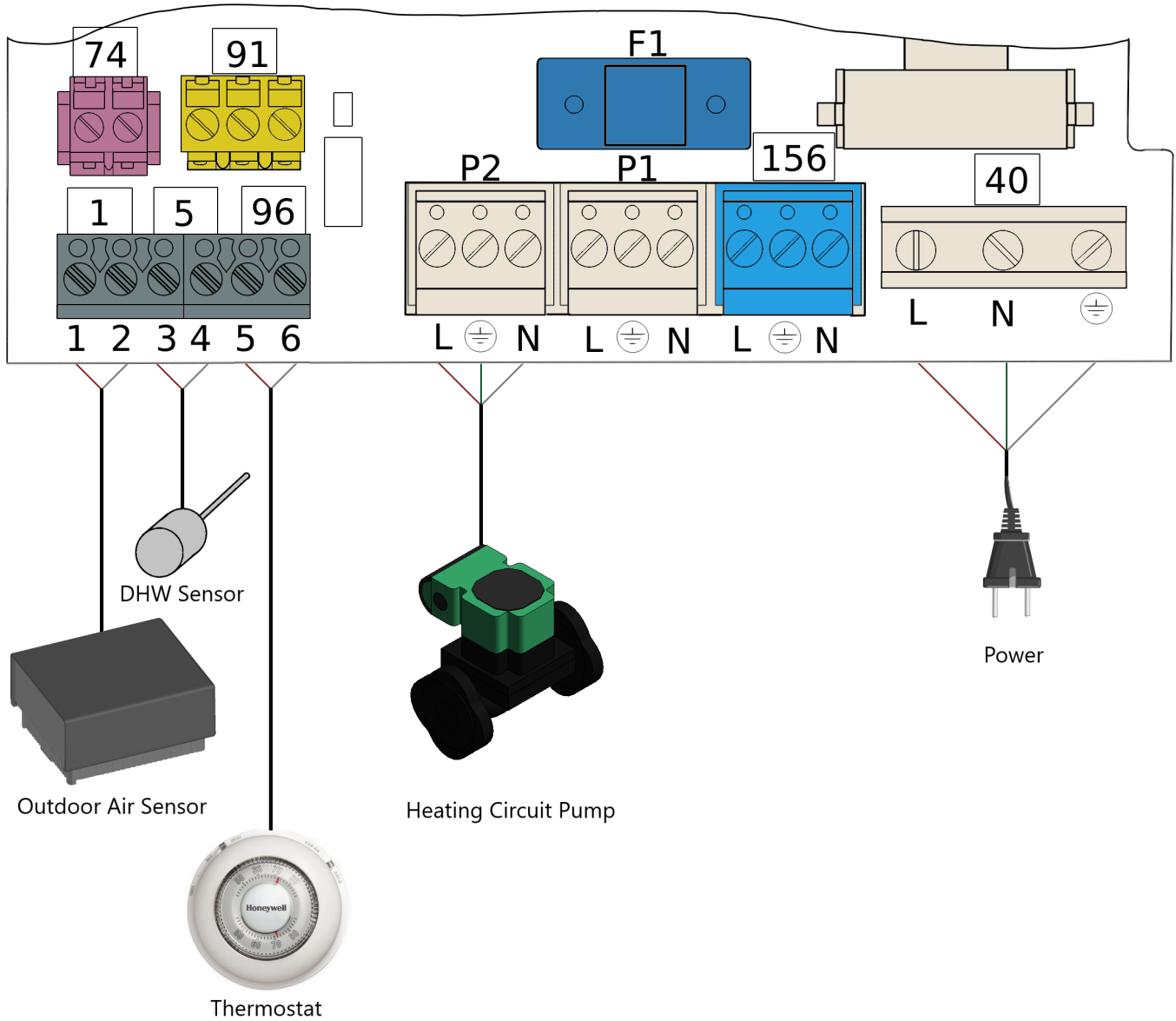

# Vitodens 100-W

# Application 2

[← Back to Index](#)

## Primary secondary

One Boiler, Single Temperature with three Heating Circuits and DHW

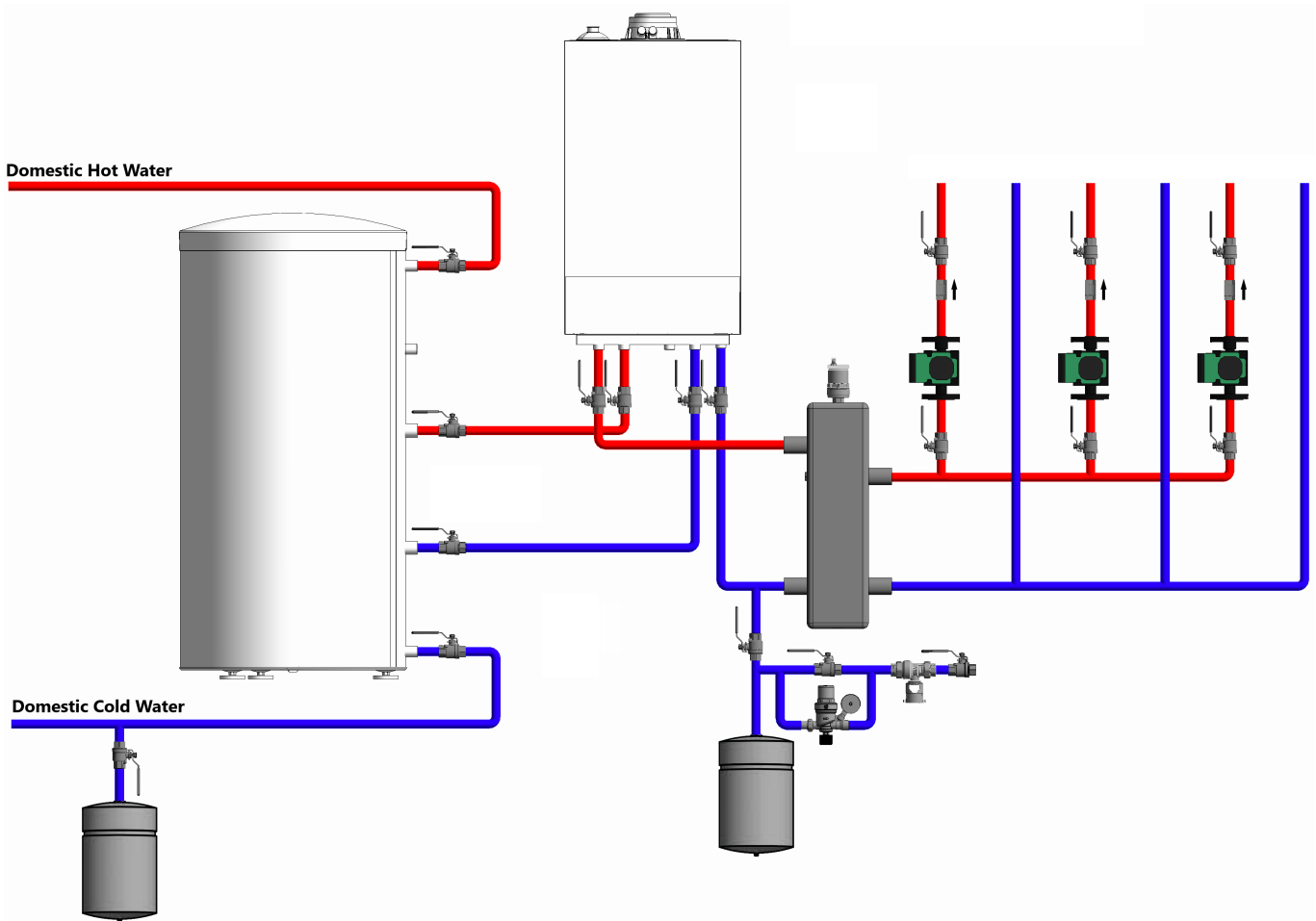

**Closely Spaced Tees**

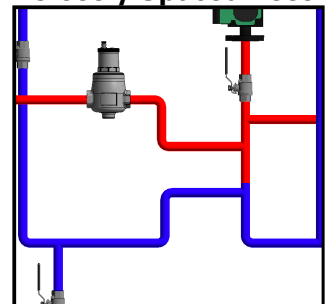

**Disclaimer:** Tempering Valves are field supplied where required by local jurisdiction.

**Disclaimer:** Refer to Installation Instructions for boiler connections when installing Viessmann Boilers, these are conceptual drawings.

# Vitodens 100-W Application 2

## Primary secondary

[← Back to Index](#)

One Boiler, Single Temperature with three Heating Circuits and DHW

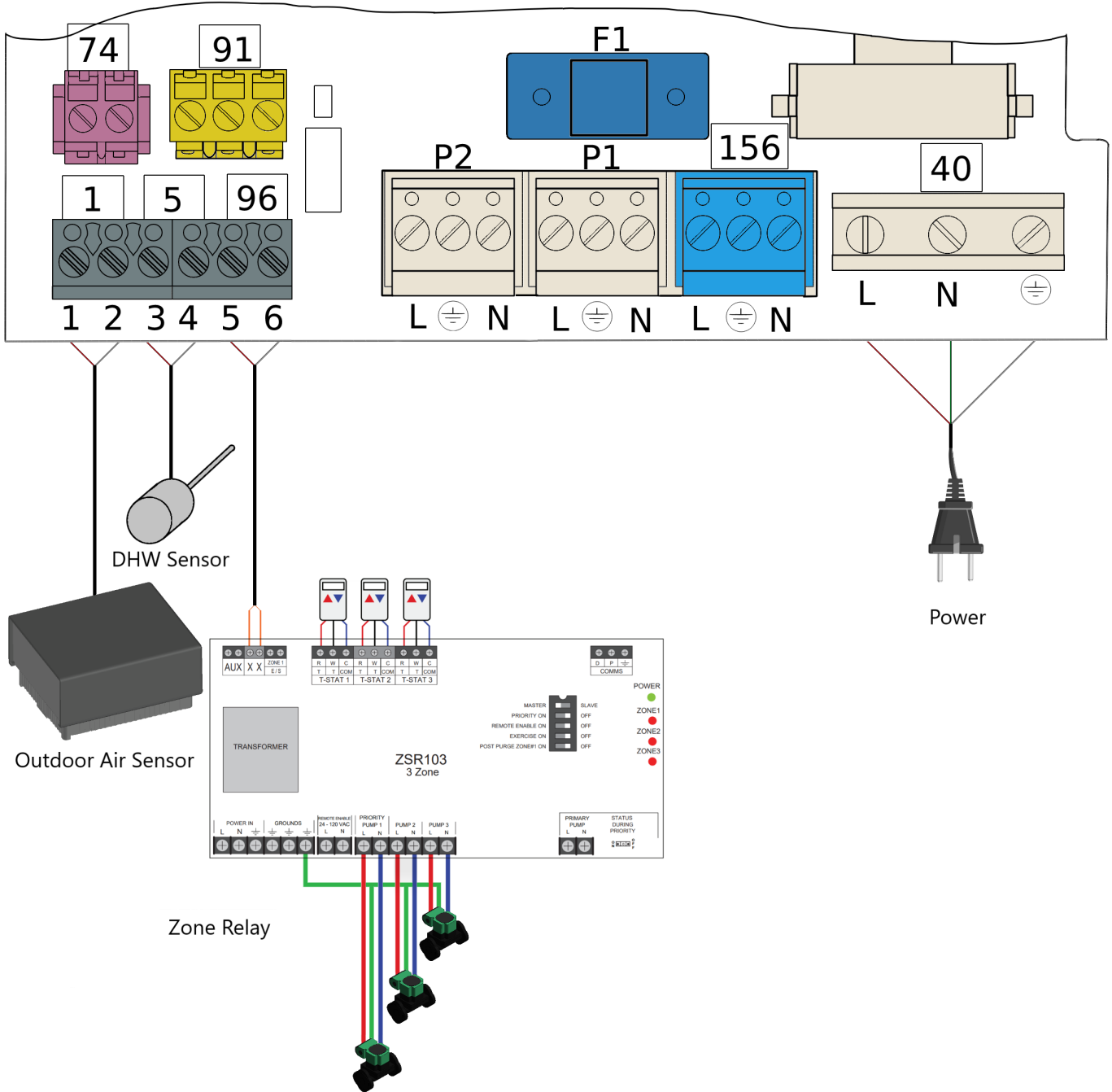

# Vitodens 100-W

# Application 3

## Primary secondary

One Boiler, Single Temperature with three Zone Valves and DHW

[← Back to Index](#)

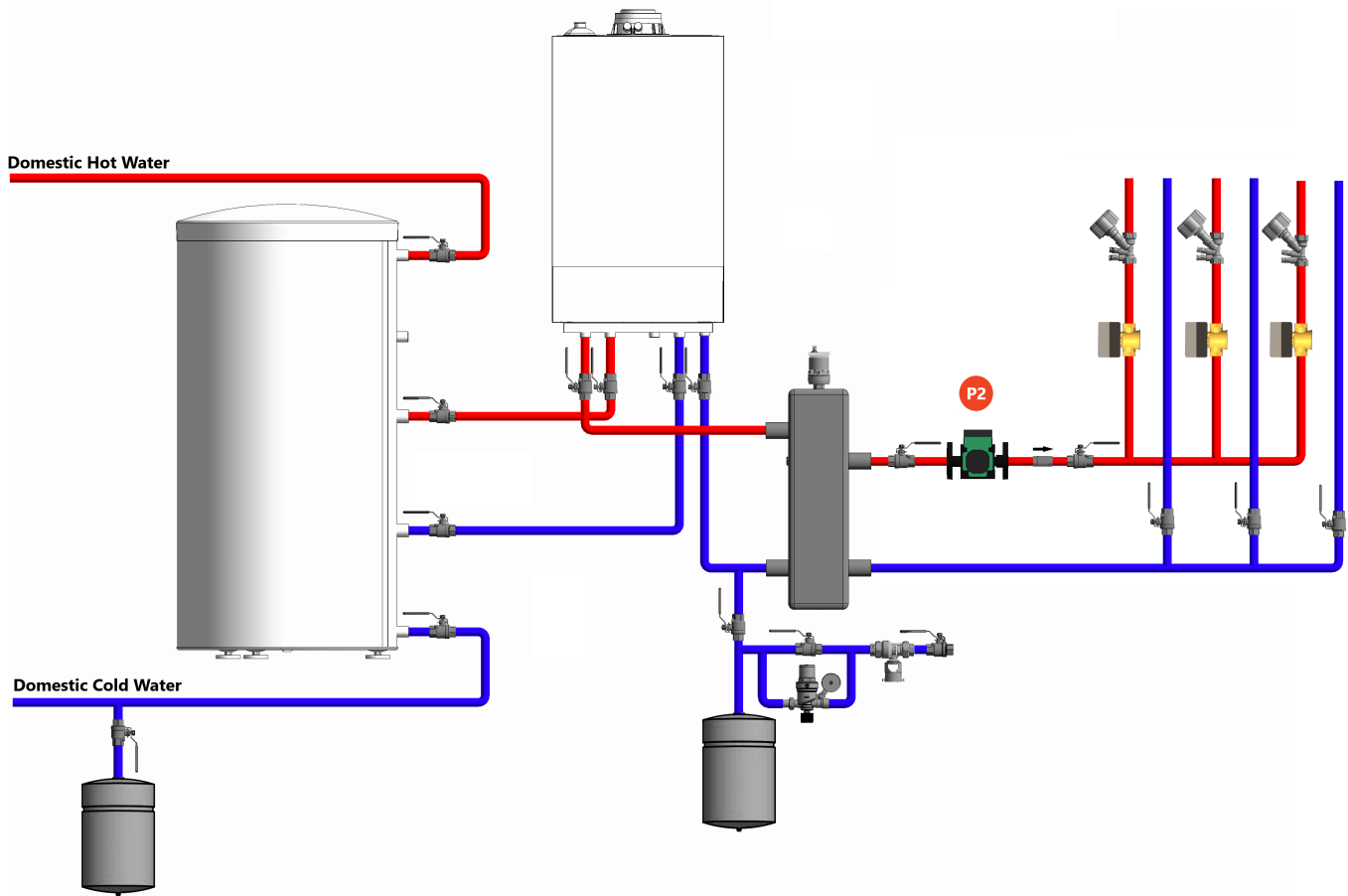

### Closely Spaced Tees

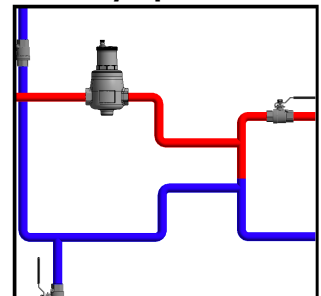

**Disclaimer:** Tempering Valves are field supplied where required by local jurisdiction.

**Disclaimer:** Refer to Installation Instructions for boiler connections when installing Viessmann Boilers, these are conceptual drawings.



# Vitodens 100-W Application 3

## Primary secondary

[← Back to Index](#)

One Boiler, Single Temperature with three Zone Valves and DHW

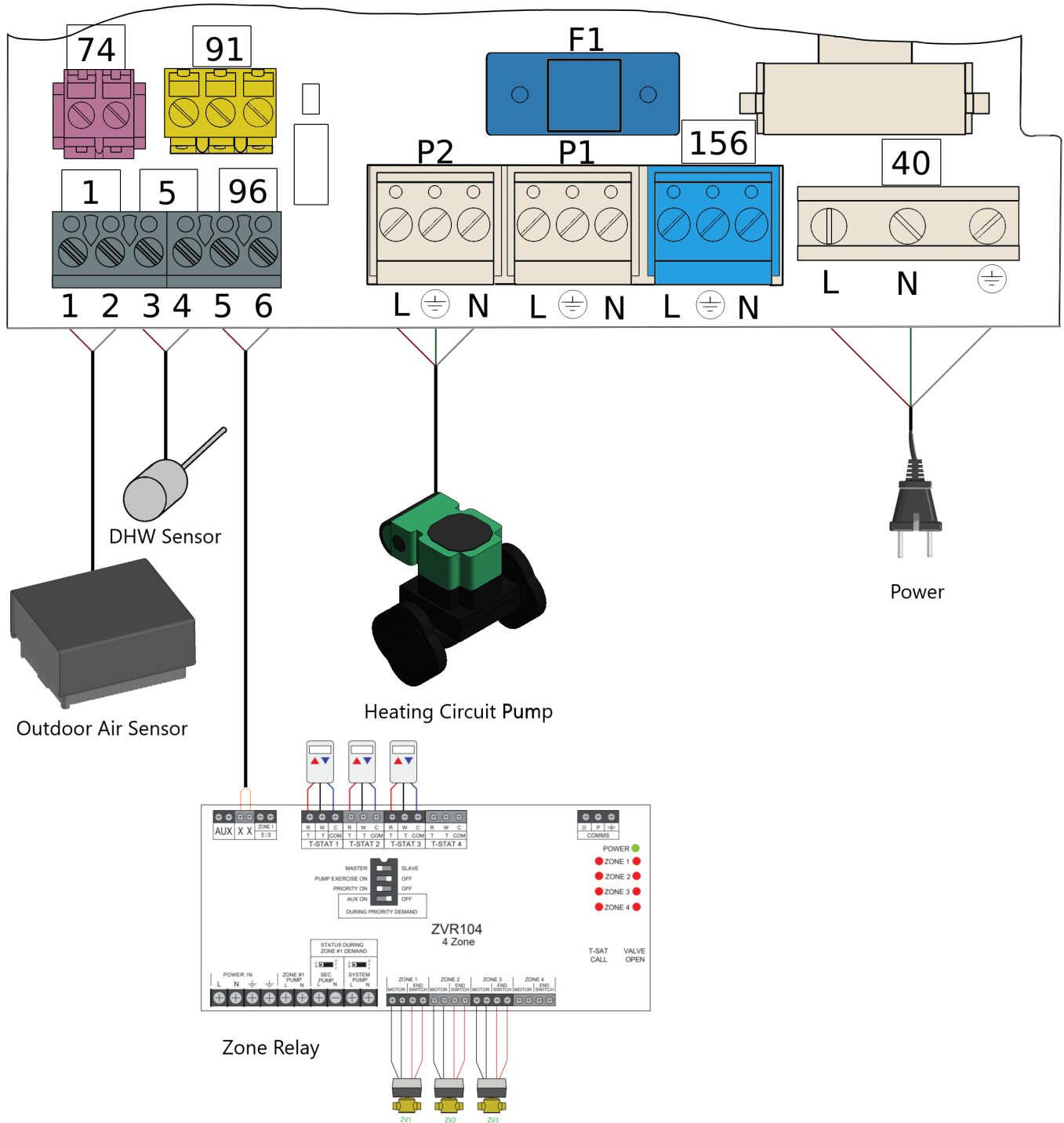

# Vitodens 100-W

# Application 4

## Primary secondary

One Boiler, Multiple Temperatures with one Mixing Valve and DHW

[← Back to Index](#)

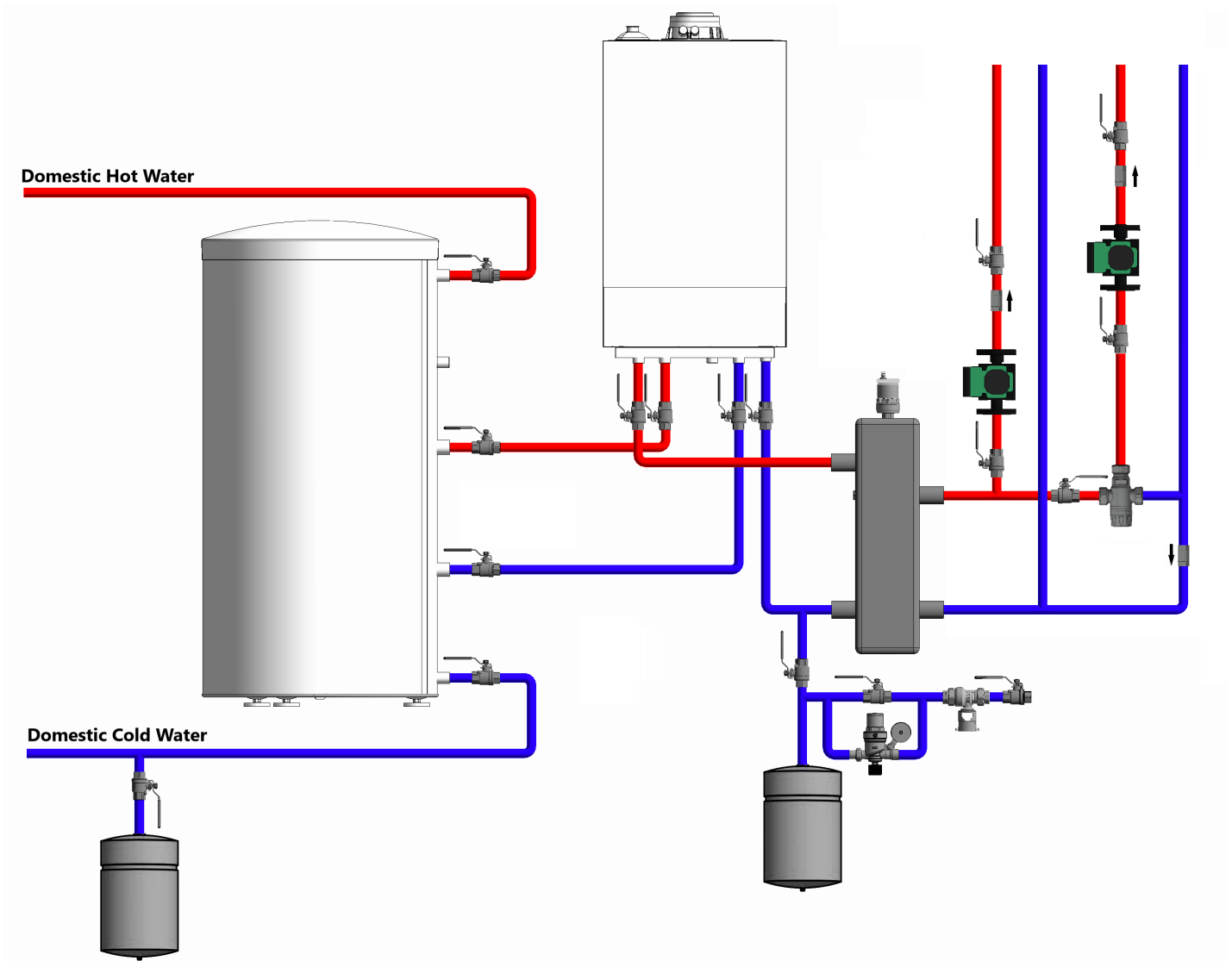

### Closely Spaced Tees

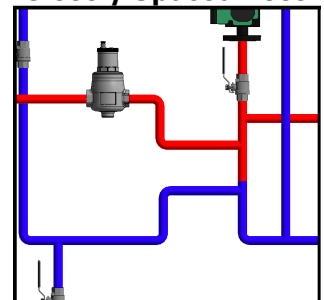

**Disclaimer:** Tempering Valves are field supplied where required by local jurisdiction.

**Disclaimer:** Refer to Installation Instructions for boiler connections when installing Viessmann Boilers, these are conceptual drawings.

# Vitodens 100-W Application 4

## Primary secondary

[← Back to Index](#)

One Boiler, Multiple Temperatures with one Mixing Valve and DHW

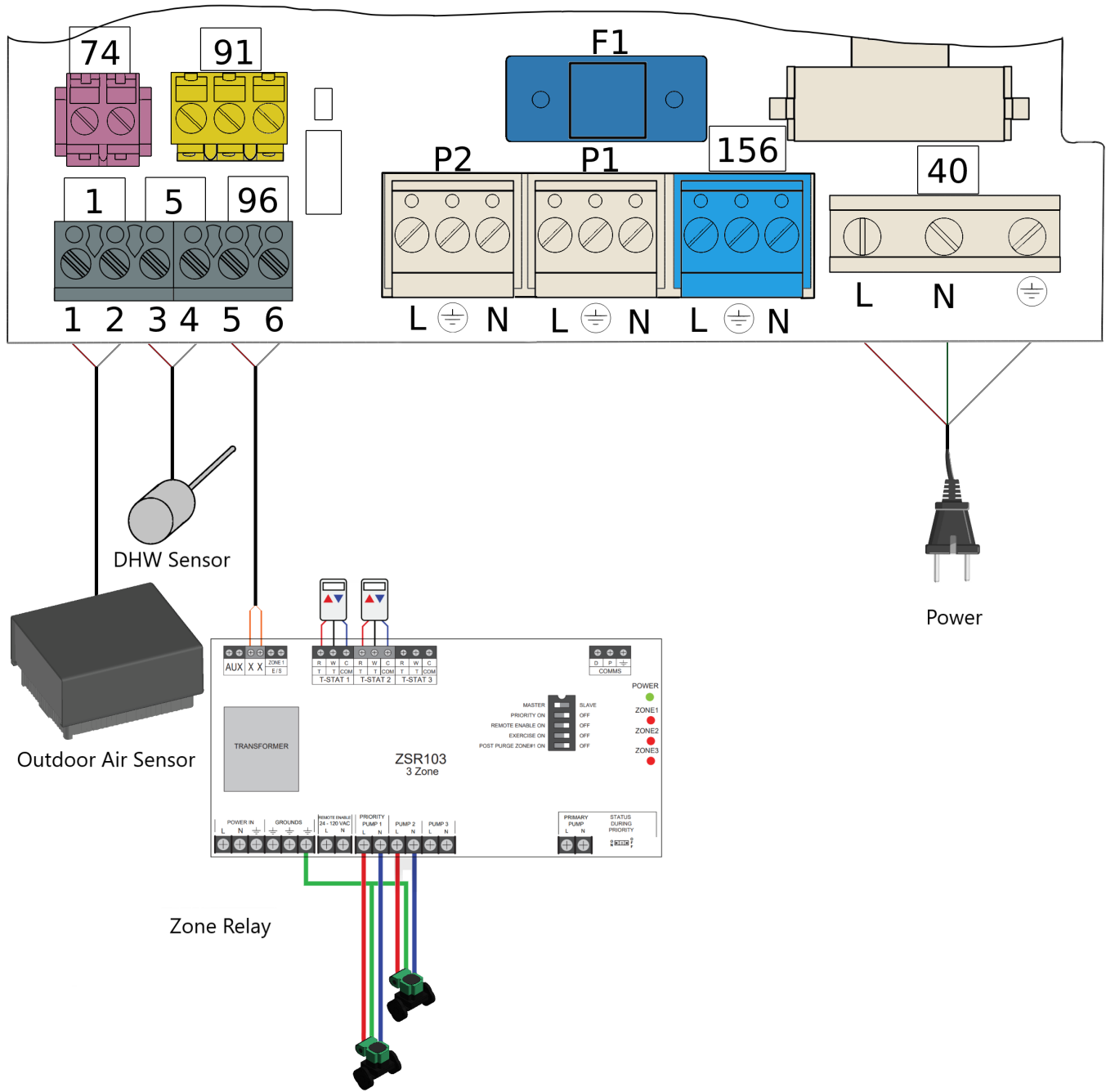

# Vitodens 100-W Application 5

## Primary secondary

One Boiler, Single Temperature with DHW on System Side

[← Back to Index](#)

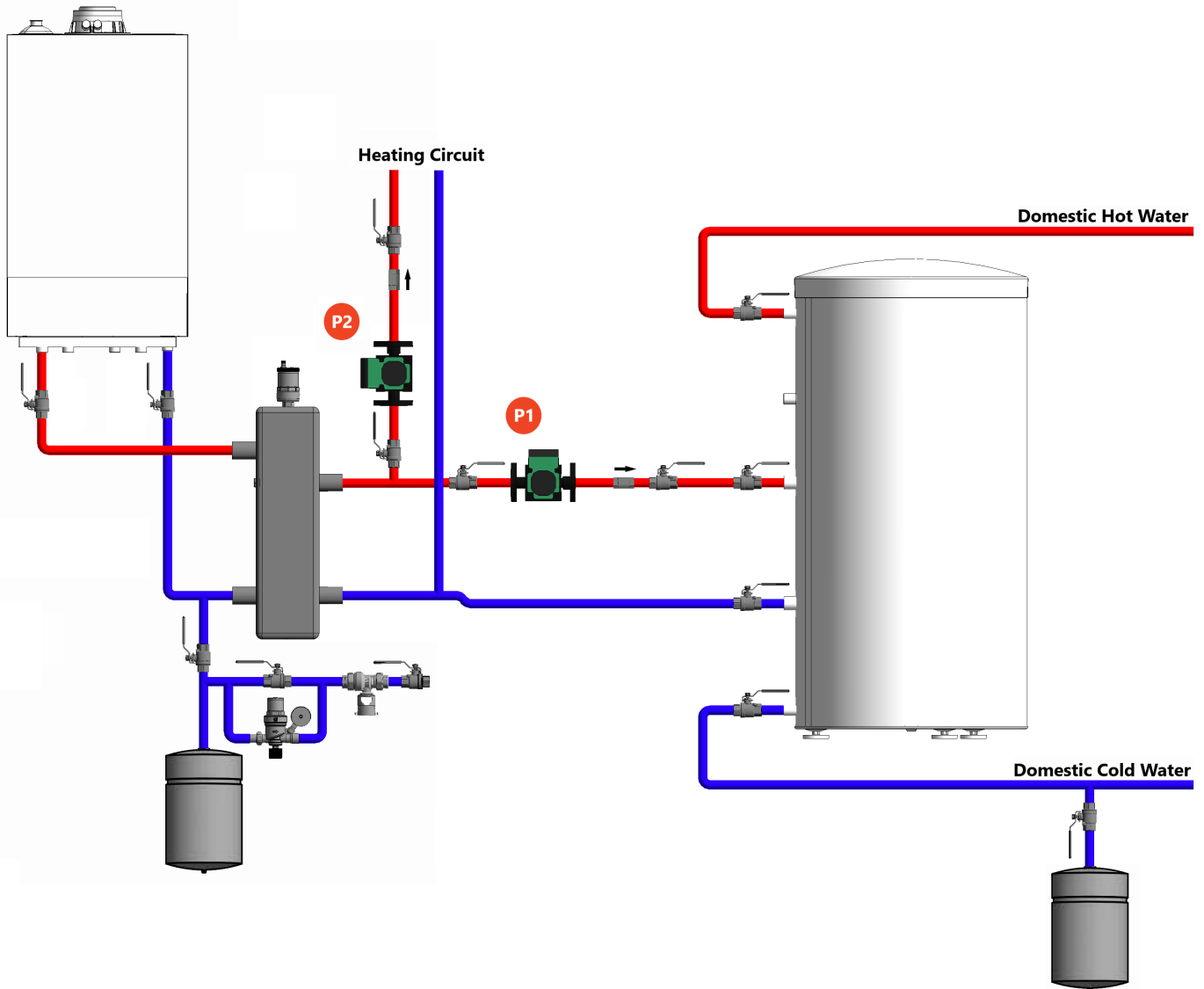

### Closely Spaced Tees

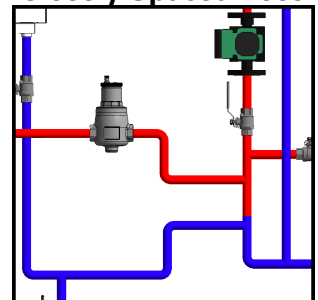

**Disclaimer:** Tempering Valves are field supplied where required by local jurisdiction.

**Disclaimer:** Refer to Installation Instructions for boiler connections when installing Viessmann Boilers, these are conceptual drawings.

# Vitodens 100-W

# Application 5

[← Back to Index](#)

## Primary secondary

One Boiler, Single Temperature with DHW on System Side

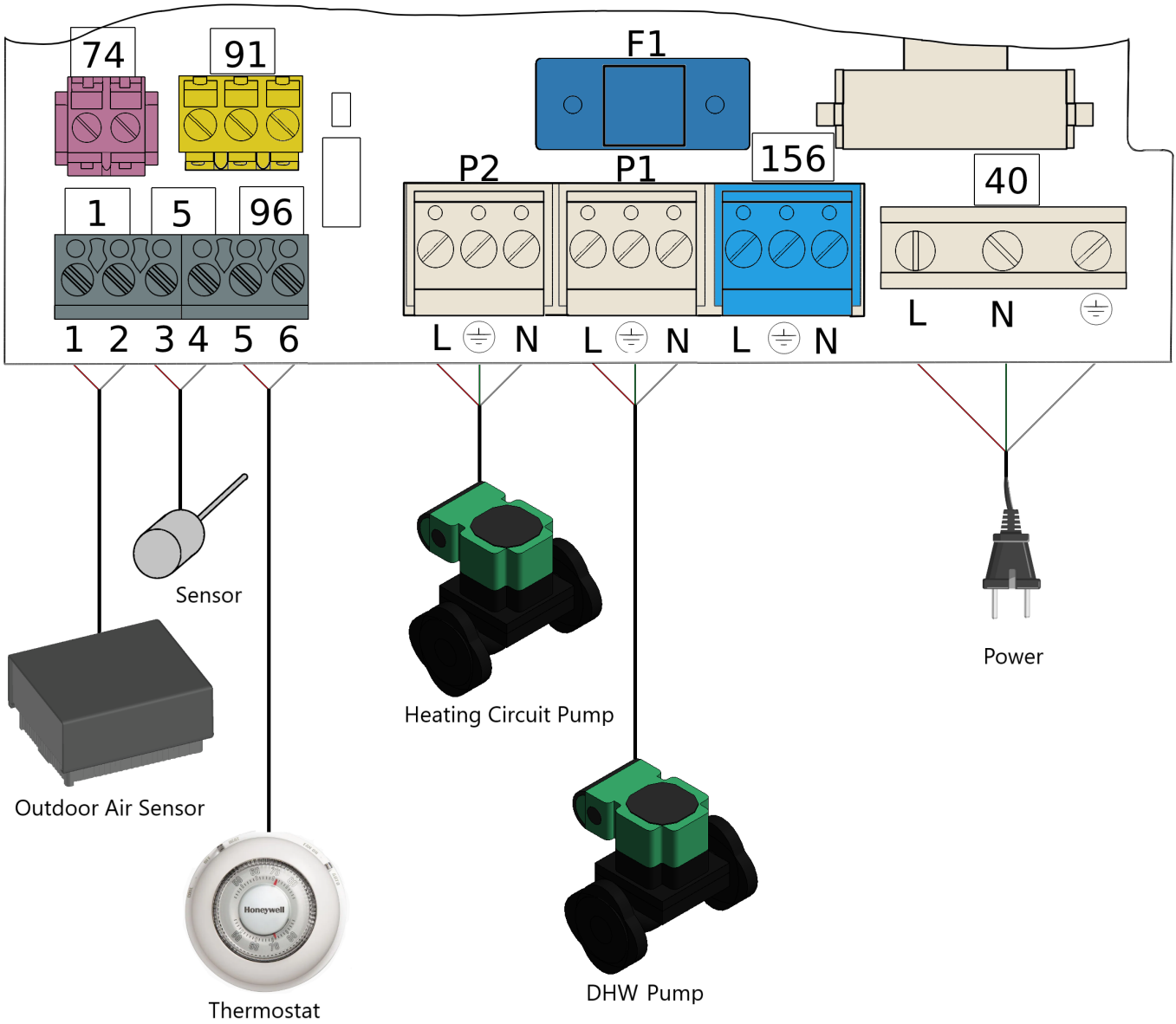

# Vitodens 100-W

# Application 6

## Primary secondary

One Boiler, Single Temperature with a single Heating Circuit and DHW

[← Back to Index](#)

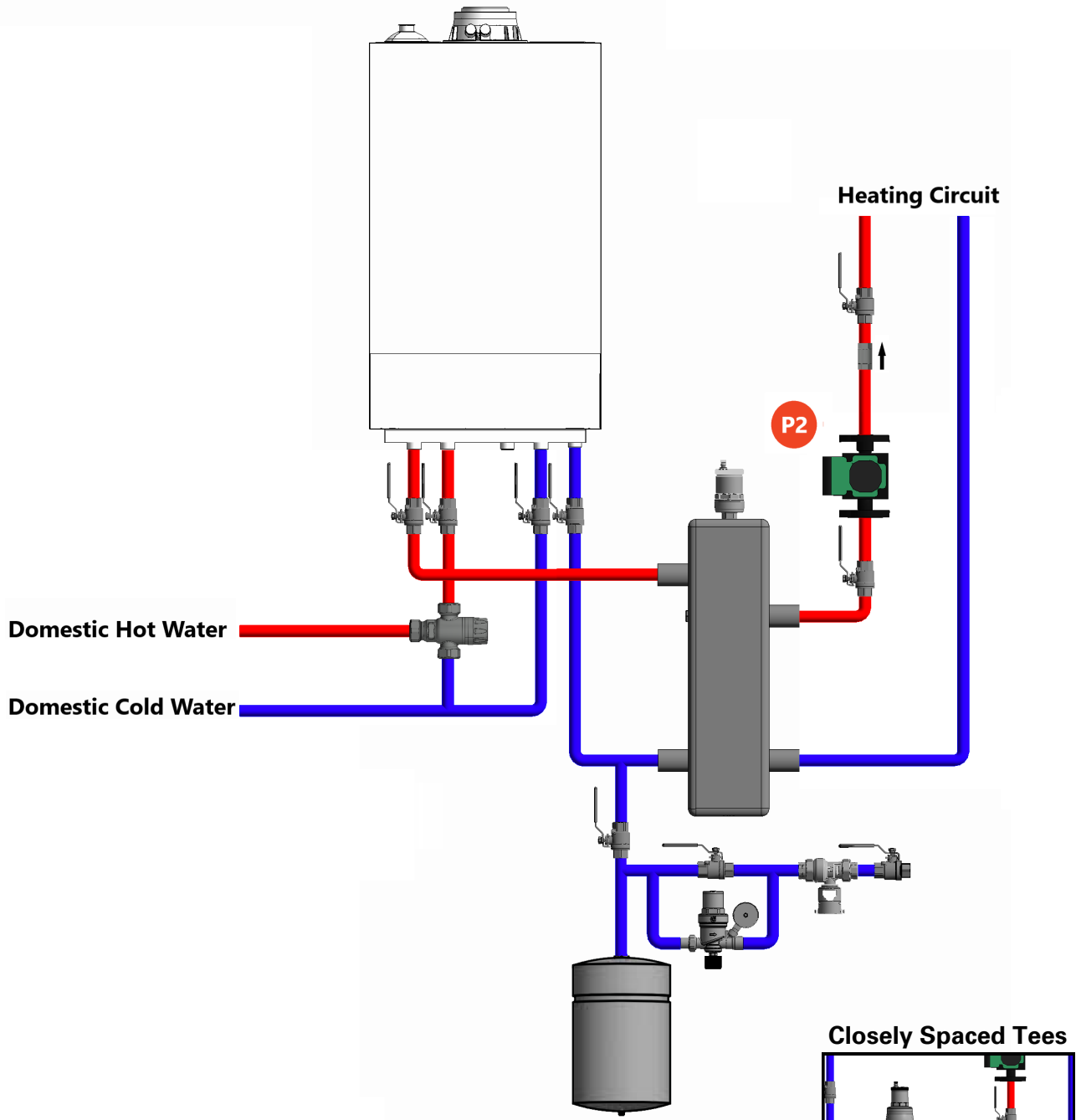

**Disclaimer:** Tempering Valves are field supplied where required by local jurisdiction.

**Disclaimer:** Refer to Installation Instructions for boiler connections when installing Viessmann Boilers, these are conceptual drawings.

# Vitodens 100-W

# Application 6

[← Back to Index](#)

## Primary secondary

One Boiler, Single Temperature with a single Heating Circuit and DHW

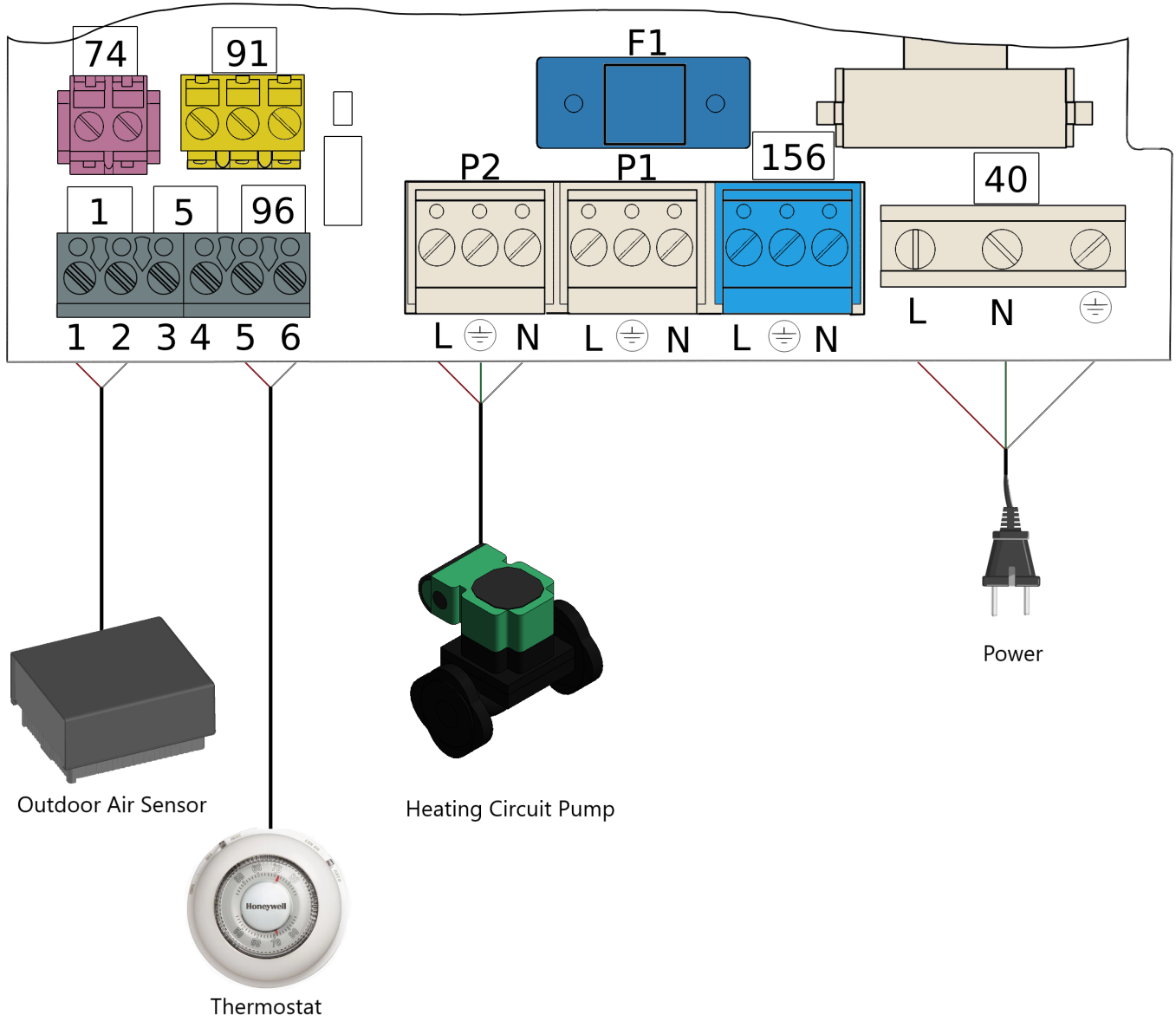

# Vitodens 100-W

# Application 7

[← Back to Index](#)

## Primary secondary

One Boiler, Single Temperature with three Heating Circuits and DHW

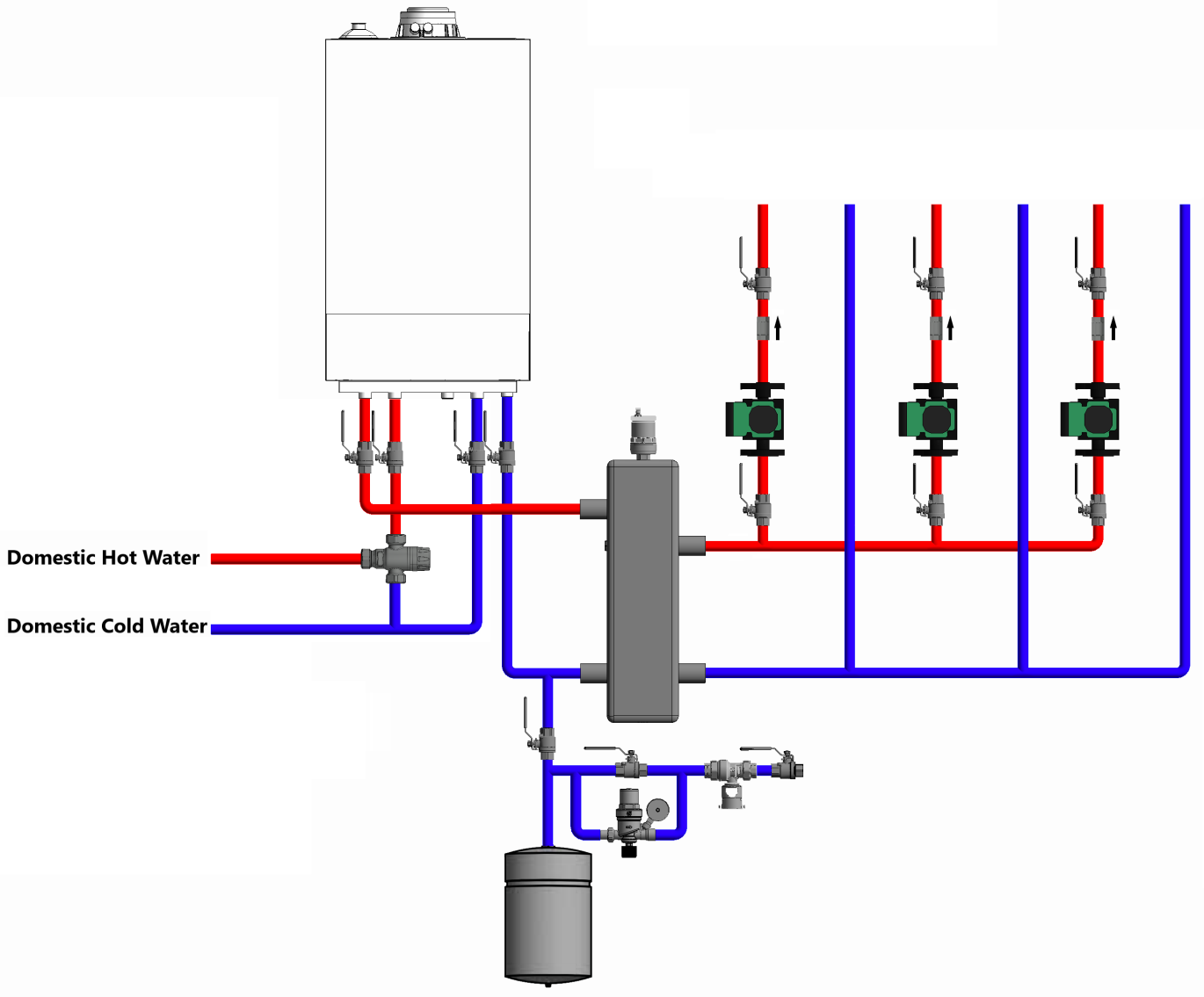

### Closely Spaced Tees

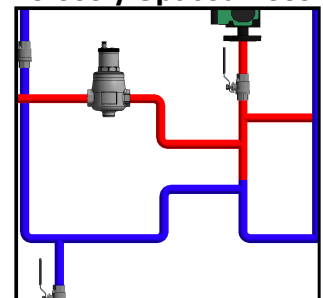

**Disclaimer:** Tempering Valves are field supplied where required by local jurisdiction.

**Disclaimer:** Refer to Installation Instructions for boiler connections when installing Viessmann Boilers, these are conceptual drawings.



# Vitodens 100-W Application 7

## Primary secondary

[← Back to Index](#)

One Boiler, Single Temperature with three Heating Circuits and DHW

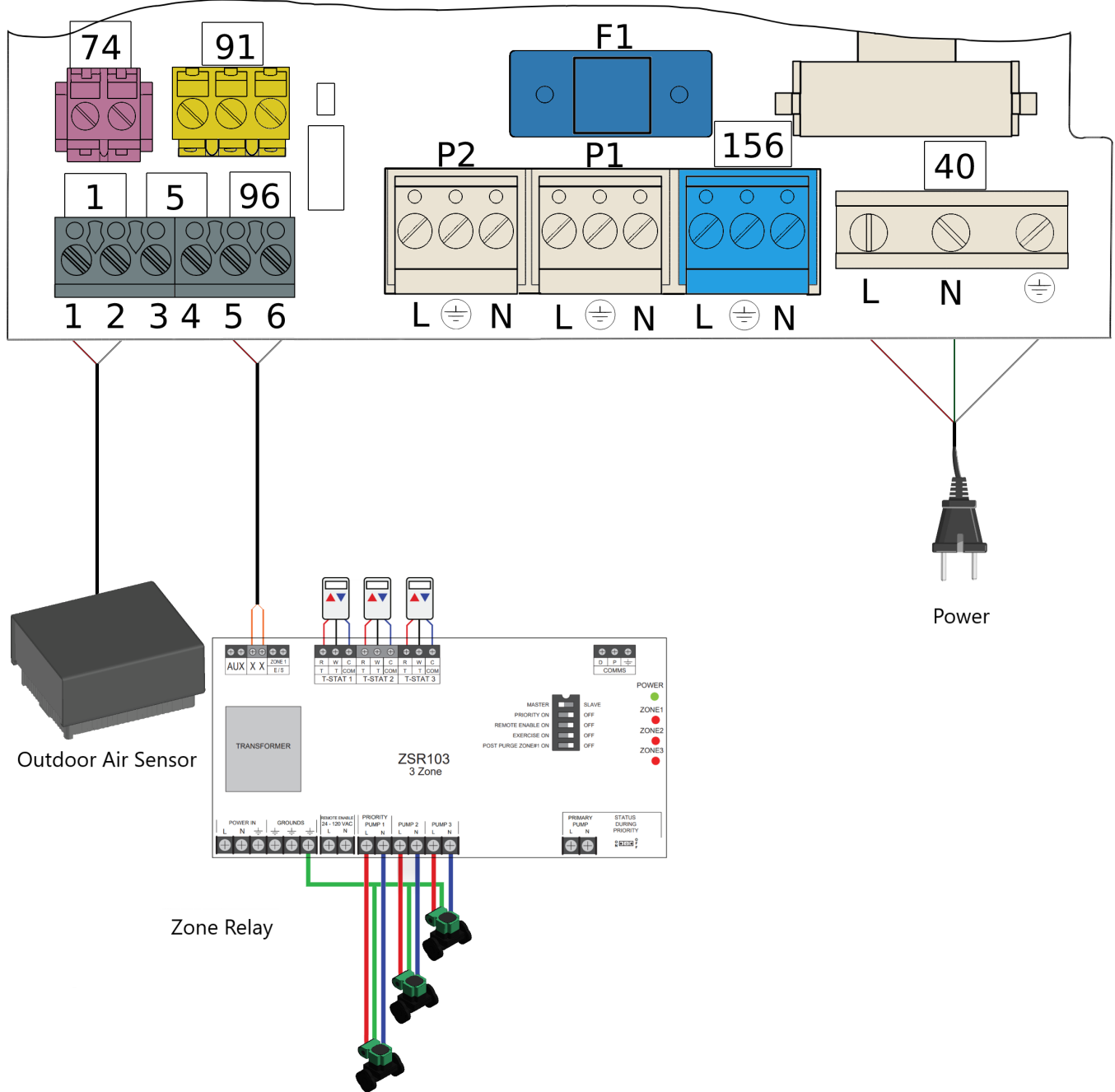

# Vitodens 100-W

# Application 8

[← Back to Index](#)

## Primary secondary

One Boiler, Single Temperature with three Zone Valves and DHW

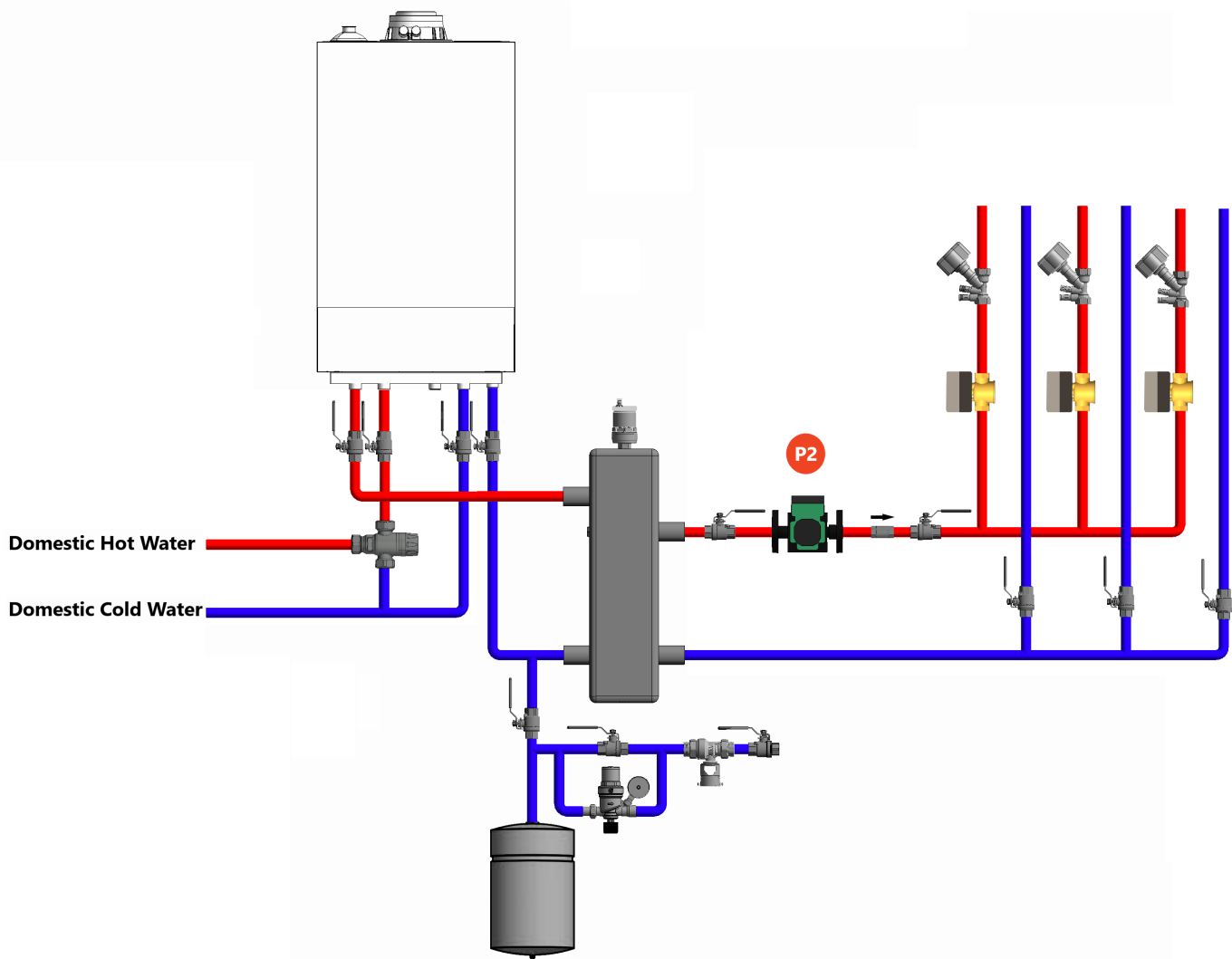

### Closely Spaced Tees

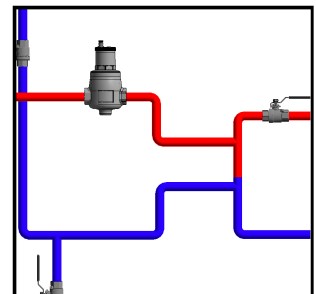

**Disclaimer:** Tempering Valves are field supplied where required by local jurisdiction.

**Disclaimer:** Refer to Installation Instructions for boiler connections when installing Viessmann Boilers, these are conceptual drawings.

# Vitodens 100-W Application 8

## Primary secondary

[← Back to Index](#)

One Boiler, Single Temperature with three Zone Valves and DHW

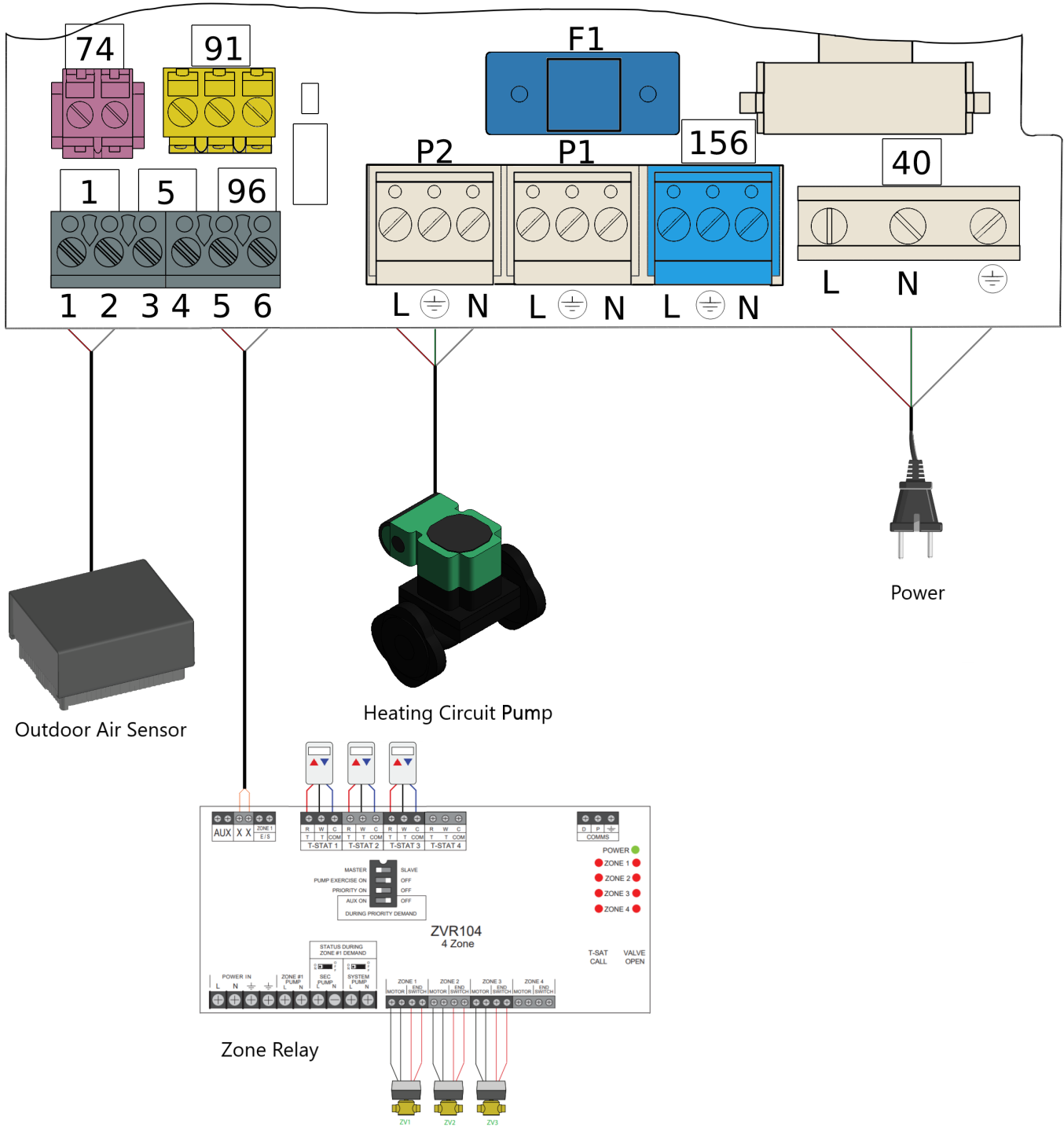

# Vitodens 100-W

# Application 9

[← Back to Index](#)

## Primary secondary

One Boiler, Multiple Temperatures with one Mixing Valve and DHW

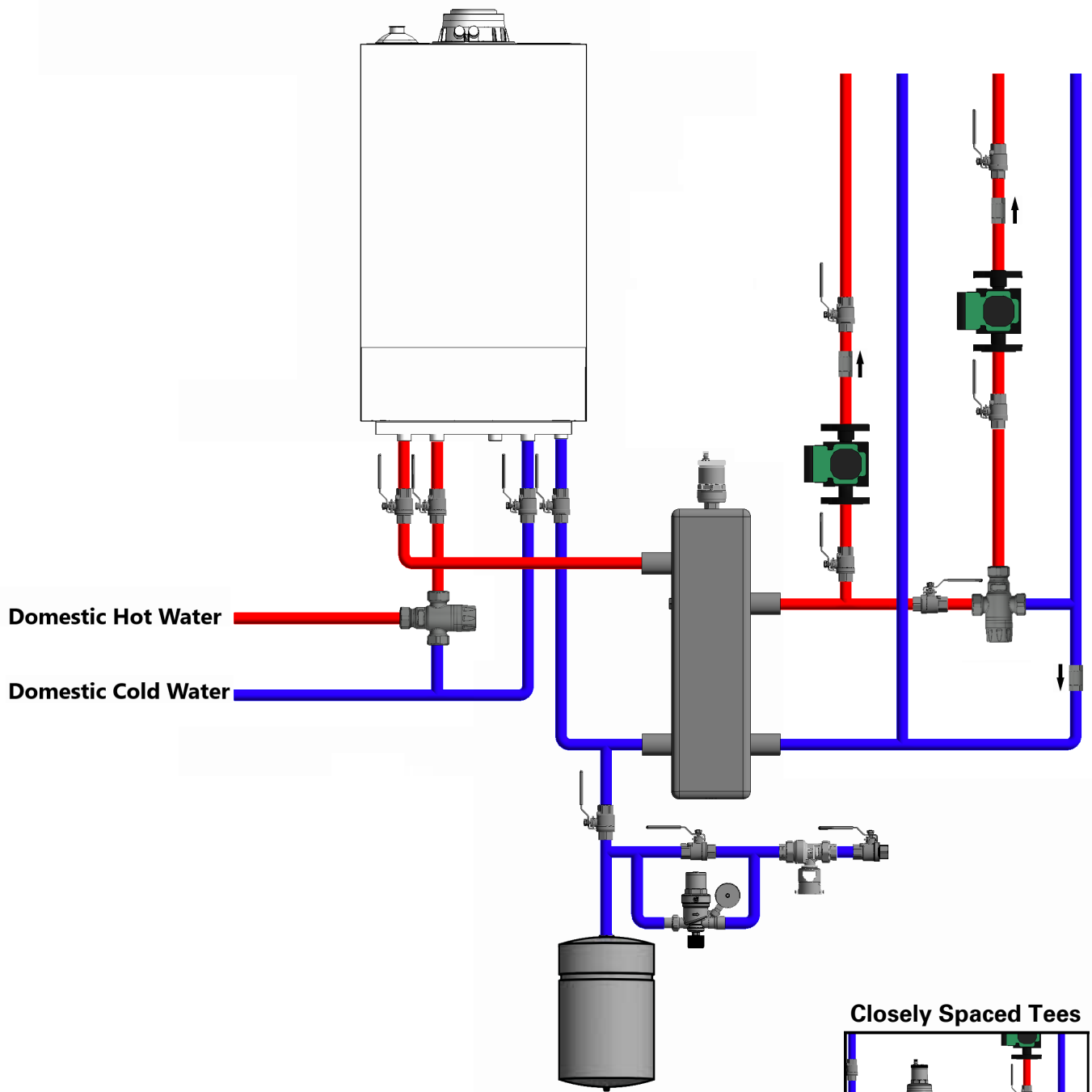

**Disclaimer:** Tempering Valves are field supplied where required by local jurisdiction.

**Disclaimer:** Refer to Installation Instructions for boiler connections when installing Viessmann Boilers, these are conceptual drawings.

**Closely Spaced Tees**

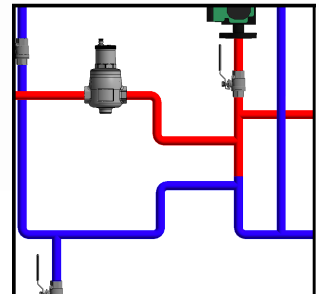

# Vitodens 100-W Application 9

## Primary secondary

[← Back to Index](#)

One Boiler, Multiple Temperatures with one Mixing Valve and DHW

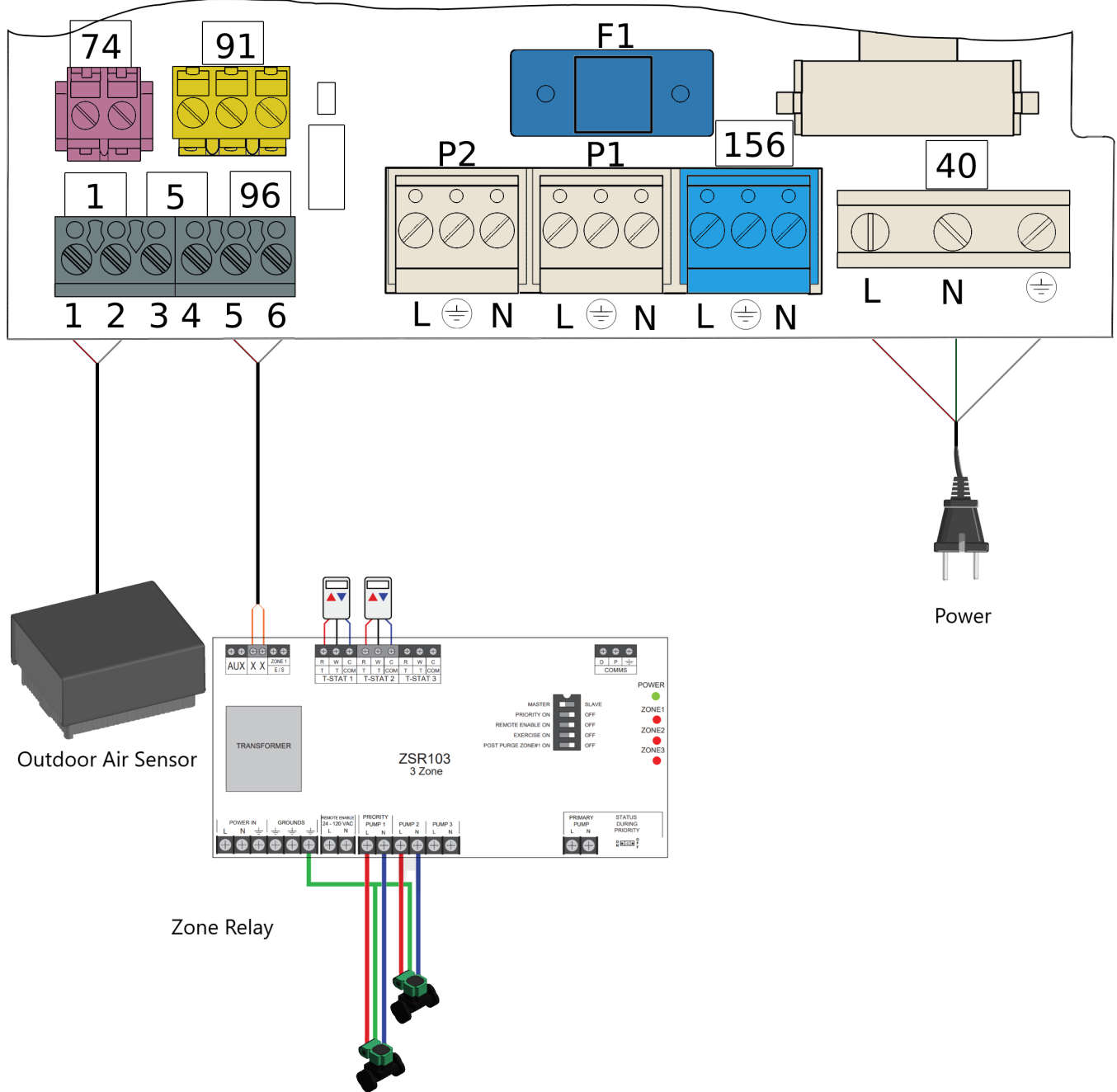

# Vitodens 100-W Gas Line Sizing Chart

[← Back to Index](#)

Schedule 40 Metallic Pipe		Gas							
		Natural							
		Inlet Pressure							
		Less than ½ psi							
		Pressure Drop							
		0.3 in. w.c.							
		Specific Gravity							
		0.6							
Pipe Size (in.)									
Nominal	1/2	3/4	1	1 1/4	1 1/2	2	2 1/2	3	4
Actual ID	0.622	0.824	1.049	1.38	1.61	2.067	2.469	3.068	4.062
Length (ft.)	MBH								
10	131	273	514	1,060	1,580	3,050	4,860	8,580	17,500
20	90	188	353	726	1,090	2,090	3,340	5,900	12,000
30	72	151	284	583	873	1,680	2,680	4,740	9,660
40	62	129	243	499	747	1,440	2,290	4,050	8,270
50	55	114	215	442	662	1,280	2,030	3,590	7,330
60	50	104	195	400	600	1,160	1,840	3,260	6,640
70	46	95	179	368	552	1,060	1,690	3,000	6,110
80	42	89	167	343	514	989	1,580	2,790	5,680
90	40	83	157	322	482	928	1,480	2,610	5,330
100	38	79	148	304	455	877	1,400	2,470	5,040
125	33	70	131	269	403	777	1,240	2,190	4,460
150	30	63	119	244	366	704	1,120	1,980	4,050
175	28	58	109	224	336	648	1,030	1,820	3,720
200	26	54	102	209	313	602	960	1,700	3,460
250	23	48	90	185	277	534	851	1,500	3,070

[← Back to Index](#)

- [Quick Start Guide](#)
- [Technical Data Manual](#)
- [Wiring Guide for B1HE](#)
- [Wiring Guide for B1KE](#)



Viessmann Manufacturing  
Company Inc.  
Warwick, RI 02886  
1-800-288-0667  
[viessmann-us.com](http://viessmann-us.com)

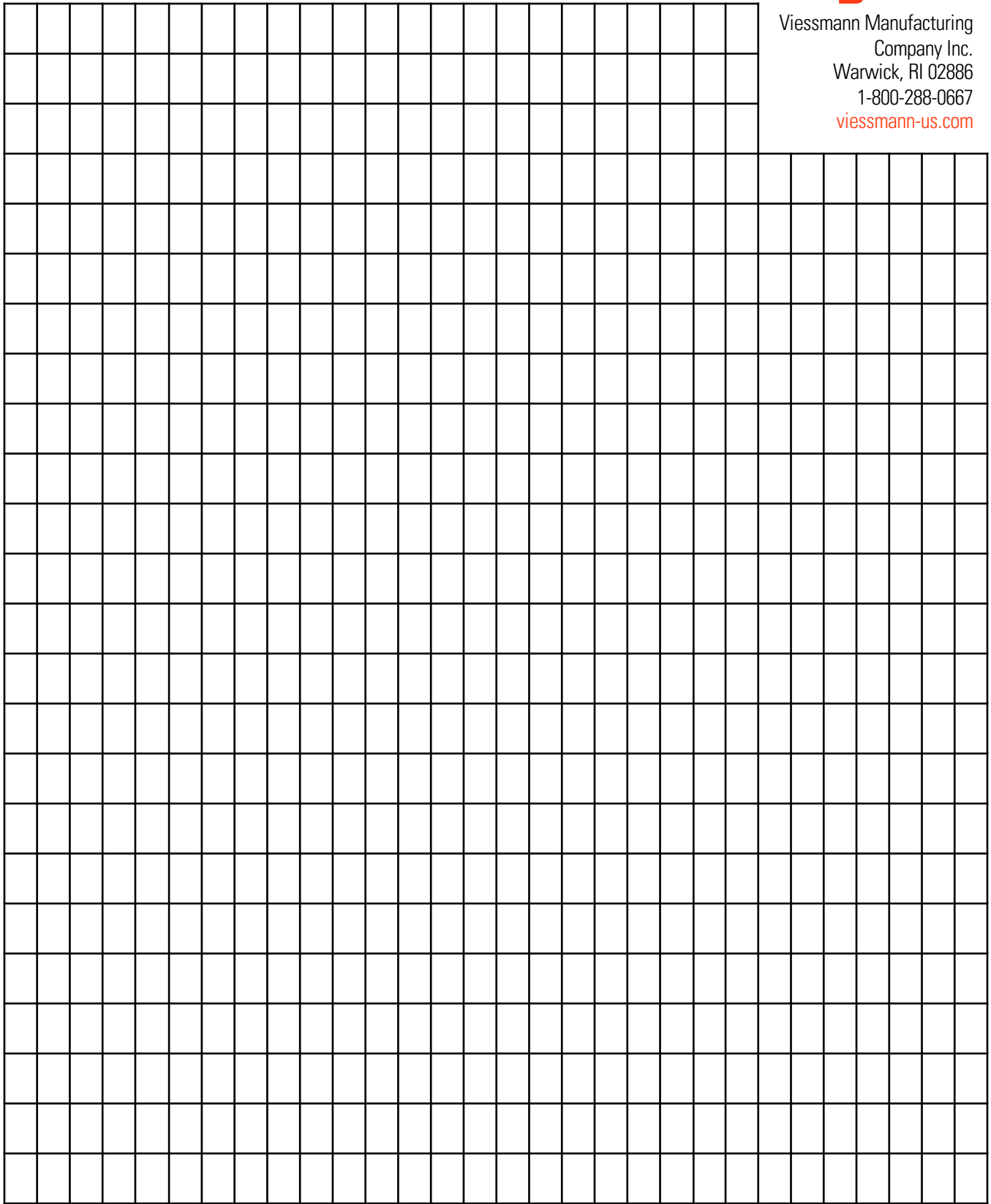

For most current product  
information, please visit  
**[viessmann-us.com](http://viessmann-us.com)**

Technical information subject to  
change without notice

