

Operating Instructions

VIESSMANN

Vitocrossal 300

CU3A Series 26 to 57

Floor mounted, gas-fired condensing boiler with MatriX gas burner and Lambda Pro control

For operation with natural gas and liquid propane gas

Heating input 19 to 199 MBH

5.6 to 58 kW



VITOCROSSAL 300

With Vitotronic 200 KW6B Controls



WARNING

If the information in this manual is not followed exactly, a fire or explosion may result causing property damage, personal injury or loss of life.

Do not store or use gasoline or other flammable liquids in the vicinity of this or any other appliance.

WHAT TO DO IF YOU SMELL GAS

- Do not try to light any appliances.
- Do not touch any electrical switches, do not use any phone in your building.
- Immediately call your gas supplier from a neighbor's phone. Follow the gas supplier's instructions.
- If you cannot reach your gas supplier, call the fire department.

Installation and service must be performed by a qualified installer, service agency or the gas supplier.

WARNING

Improper installation, adjustment, and/or operation could cause carbon monoxide poisoning resulting in injury or loss of life.

This product must be installed and serviced by a professional service technician who is experienced and qualified in hot water boiler installation and gas combustion.

Product may not be exactly as shown

IMPORTANT

Read and save these instructions for future reference.



Energy Verified



Safety, Installation and Warranty Requirements

Please ensure that these instructions are read and understood before commencing installation. Failure to comply with the instructions listed below and details printed in this manual can cause product/property damage, severe personal injury, and/or loss of life. Ensure all requirements below are understood and fulfilled (including detailed information found in manual subsections).

■ **Product documentation**

Read all applicable documentation before commencing installation. Store documentation near boiler in a readily accessible location for reference in the future by service personnel.

► *For a listing of applicable literature, please see section entitled "Important Regulatory and Safety Requirements".*



■ **Warranty**

Information contained in this and related product documentation must be read and followed. Failure to do so renders the warranty null and void.



■ **Licensed professional heating contractor**

The installation, adjustment, service and maintenance of this equipment must be performed by a licensed professional heating contractor.

► *Please see section entitled "Important Regulatory and Installation Requirements".*



■ **Contaminated air**

Air contaminated by chemicals can cause by-products in the combustion process, which are poisonous to inhabitants and destructive to Viessmann equipment.

► *For a listing of chemicals which cannot be stored in or near the boiler room, please see subsection entitled "Mechanical room" in the "Installation Instructions".*



■ **Advice to owner**

Once the installation work is complete, the heating contractor must familiarize the system operator/ultimate owner with all equipment, as well as safety precautions/requirements, shutdown procedure, and the need for professional service annually before the heating season begins.

■ **Carbon monoxide**

Improper installation, adjustment, service and/or maintenance can cause flue products to flow into living space. Flue products contain poisonous carbon monoxide gas.

► *For information pertaining to the proper installation, adjustment, service and maintenance of this equipment to avoid formation of carbon monoxide, please see subsection entitled "Mechanical room" and "Venting requirements" in the "Installation Instructions".*



■ **Fresh air**

This equipment requires fresh air for safe operation and must be installed ensuring provisions for adequate combustion and ventilation air exist.

► *For information pertaining to the fresh air requirements of this product, please see subsection entitled "Mechanical room" in the "Installation Instructions".*

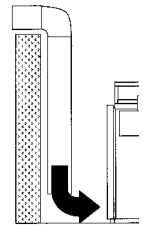

■ **Equipment venting**

Never operate boiler without an installed venting system. An improper venting system can cause carbon monoxide poisoning.

► *For information pertaining to venting and chimney requirements, please see section entitled "Venting Connection". All products of combustion must be safely vented to the outdoors.*



! WARNING

Installers must follow local regulations with respect to installation of carbon monoxide detectors. Follow the Viessmann maintenance schedule of the boiler contained in this manual.

! WARNING

This boiler requires fresh air for safe operation and must be installed with provisions for adequate combustion and ventilation air (in accordance with local codes and regulations of authorities having jurisdiction).

Do not operate this boiler in areas with contaminated combustion air. High levels of contaminants such as dust, lint or chemicals can be found at construction sites, home renovations, in garages, workshops, in dry cleaning/laundry facilities, near swimming pools and in manufacturing facilities.

Contaminated combustion air will damage the boiler and may lead to substantial property damage, severe personal injury and/or loss of life. Ensure boiler/burner is inspected and serviced by a qualified heating contractor at least once a year in accordance with the Service Instructions of the boiler.

Operating and Service Documentation

It is recommended that all product documentation such as parts lists, operating and service instructions be handed over to the system user for storage. Documentation is to be stored near boiler in a readily accessible location for reference by service personnel.

	Page
Safety	
	Safety, Installation and Warranty Requirements2
	About these Instructions6
	For your Safety6
	Operation6
	Working on the equipment6
	Maintenance and cleaning.....6
	Flue gas smell6
	Dangerous conditions6
	Technical information6
	Carbon monoxide.....7
	For safe operation.....7
	Frozen water pipe hazard8
	Replacement components, spare and wear parts.....8
	Installation area conditions.....8
	Sources of combustion and ventilation air contaminants8
General Information	
	Commissioning9
	Terminology9
	Your System is Preset at the Factory9
	Central heating.....9
	Time and date9
	Power failure.....9
	DWH heating9
	Frost protection.....9
	Wintertime/summertime changeover.....9
	Energy Savings Tips10
	Central heating.....10
	DHW heating10
	Tips for More Comfort11
	DHW heating11
	Central heating.....11
Controls	
	Opening the Control Unit11
	Overview of Controls12
	Modular structure12
	Programming unit (H01B).....12
Operation	
	Programming Unit13
	“Help” menu13
	Symbols13
	Standard Menu14
	Setting the standard room temperature for the primary heating circuit.....14
	Setting the operation program for the primary heating circuit.....14
	Extended Menu14
	How to Use the Controls15
	Operating Program16
	Operating programs for central heating, DHW, frost protection16
	Special operating programs15
	With frost protection monitoring16
	Without frost protection monitoring.....16
	Information on a prolonged shutdown.....16
	Time Program17
	Example of time phases within the time program for central heating17
	Setting a time program17
	Setting a time program using central heating17
	Setting the time program efficiently18
	Deleting time phases18

	Page
Start-up/Shutdown	
Starting the Heating System	19
Shutting Down the Heating System	19
With frost protection monitoring	19
For the primary heating circuit	19
For all heating circuits	19
Pump exercise function	19
Ending the heating program "Standby mode"	19
Without frost protection monitoring.....	19
Information on an extended shutdown.....	19
Central Heating	
Room Temperature	20
Setting the standard room temperature for central heating.....	20
Setting the reduced room temperature for central heating	20
Setting the Operating Program for Central Heating	20
Time Program	20
Setting the time program for central heating.....	20
Heating Curve	21
Setting the heating curve.....	21
End Central Heating	21
For the primary heating circuit	21
Comfort Function "Party Mode"	22
Selecting the comfort function "Party mode"	22
Setting "Party mode" for central heating.....	22
Cancelling "Party mode"	22
Energy Saving Function "Economy Mode"	22
Selecting the energy savings function "Economy mode"	22
Setting "Economy mode" for central heating	22
Cancelling "Economy mode"	22
Energy Saving Function "Holiday Program"	23
Selecting the energy savings function "Holiday program"	23
Setting "Holiday Program" for central heating.....	23
Display in the extended menu.....	23
Cancelling or deleting the "Holiday program".....	23
DHW Heating	
Setting the DHW Temperature	24
Factory setting 122°F (50°C)	24
Operating Program	24
Setting the operating program for DHW heating.....	24
Time Program	25
Setting the time program for DHW heating.....	25
DHW heating outside of the time program.....	25
Setting the time program for the DHW recirculation pump	25
Switching Off DHW Heating	26
Additional Adjustments	
Setting the Display Contrast	27
Setting the Display Brightness	27
Entering Names for the Heating Circuits	27
Setting the Primary Heating Circuit for the Standard Menu	28
Setting the Time and Date	28
Language Selection	28
Setting the Temperature Unit °F °C	29
Restoring Factory Settings	29

	Page
Scanning	
Scanning Information	30
Calling up the solar yield in conjunction with solar thermal systems	30
Resetting data	30
Scanning the Service Messages	31
Calling up an acknowledged service message	31
Scanning Fault Messages	32
Calling up an acknowledged fault message	32
Emissions	
Emissions Test Mode	33
Ending emissions test mode	33
Troubleshooting	
Rooms are too Cold	34
Rooms are too Hot	35
There is no Hot Water	35
The DHW is too Hot	35
"Flashes" and "Fault" is Displayed	36
"Flashes" and "Service" is Displayed	36
"Controls Locked Out" is Displayed	36
"External Hook-up" is Displayed	36
"External Program" is Displayed	36
Maintenance	
Inspection/Cleaning/Maintenance	37
Cleaning	37
Inspection and maintenance	37
Boiler	37
DHW tank	37
Safety valve (DHW tank)	37
Potable water filter (if installed)	37
Additional Information	
Overview of Extended Menu	38
Calling up Options Under "Information"	39
Scanning options in the extended menu	39
Terminology	40
Operating program	40
Operating status	40
Extension kit for heating circuit with mixing valve	40
Mixing valve	40
Under floor heating system	40
Standard heating mode	40
Reduced heating mode	40
Room temperature-dependent heating mode	40
Weather-compensated heating mode	40
Heating curve	41
Heating circuit	42
Heating circuit pump	42
Room temperature	42
Safety valve	42
Solar circuit pump	42
Set temperature	42
DHW pump	42
Drinking water filter	42
Weather-compensated heating mode	42
DHW recirculation pump	42

About these Instructions

 Take note of all symbols and notations intended to draw attention to potential hazards or important product information. These include “WARNING”, “CAUTION”, and “IMPORTANT”. See below.

 **WARNING**

Indicates an imminently hazardous situation which, if not avoided, could result in loss of life, serious injury or substantial product/property damage.

► *Warnings draw your attention to the presence of potential hazards or important product information.*

 **CAUTION**

Indicates an imminently hazardous situation which, if not avoided, may result in minor injury or product/property damage.

► *Cautions draw your attention to the presence of potential hazards or important product information.*

IMPORTANT

► *Helpful hints for installation, operation or maintenance which pertain to the product.*



► *This symbol indicates that additional, pertinent information is to be found.*



► *This symbol indicates that other instructions must be referenced.*

For your Safety

Operation

Before operating the boiler, make sure you fully understand its method of operation. Your heating contractor should always perform the initial start-up and explain the system. Any warranty is null and void if these instructions are not followed.

Working on the equipment

All personnel working on the equipment or the heating system must have the proper qualifications and hold all necessary licenses.

Ensure main power to equipment, heating system, and all external controls has been deactivated. Close main gas supply valve. Take precautions in all instances to avoid accidental activation of power during service work.

Maintenance and cleaning

Regular inspection and service by a qualified heating contractor is important to the performance of the Viessmann Vitocrossal 300 CU3A Series. Neglected maintenance impacts on warranty; regular inspection ensures clean, environmentally friendly and efficient operation. We recommend a maintenance contract with a qualified heating contractor.

Flue gas smell

- Deactivate heating equipment.
- Open windows and doors.
- Inform your heating contractor.

Dangerous conditions

- Deactivate main power immediately.
- Close gas supply valve.

Technical information

Literature applicable to all aspects of the Vitocrossal 300 CU3A Series:

- Technical Data Manual
- Installation Instructions
- Service Instructions
- Operating Instructions and User's Information Manual

Additional applicable literature:

- Accessory manuals

For your Safety *(continued)*

Carbon monoxide

The U.S. Consumer Product Safety Commission strongly recommends the installation of carbon monoxide detectors in buildings in which gas-burning equipment is installed. Carbon monoxide (CO) is a colorless, odorless gas, which may be produced during incomplete combustion of fuel and/or when the flame does not receive an adequate supply of combustion air.

Carbon monoxide can cause severe personal injury or loss of life.

Therefore, carbon monoxide detectors that are in compliance with a nationally recognized standard (e.g. ANSI/UL 2034, CSA 6.19) should be installed and maintained in buildings that contain gas-burning equipment.

Note: Viessmann does not test any detectors and makes no representation regarding any brand or type of detector.

For safe operation

We recommend that you frequently:

- Check for debris which could obstruct the flow of flue gases. The vent or chimney must not be blocked. A blocked or partially blocked vent or chimney can cause flue gases to leak into the structure. Flue gases leaking into the house can cause injury or loss of life. Blocked or partially blocked chimneys must have the blockage removed by a qualified heating contractor.
- Check pressure gage for correct system (water) pressure. Check for water on the floor from the discharge pipe of the pressure relief valve or any other pipe, pipe joint, valve or air vent.
- Check for moisture, water, or appearance of rust on the flue gas pipes, their joints as well as vent dampers, or side wall vent terminals (if so equipped).
- Ensure that nothing is obstructing the flow of combustion and ventilation air and no chemicals, garbage, gasoline, combustible materials, flammable vapors and liquids are stored (not even temporarily) in the vicinity of the boiler.
- Do not allow unsupervised children near the boiler.

Service/inspection of the boiler and the system is recommended once a year. Maintenance, service and cleaning are specified in the Installation Instructions.

Before the heating season begins, it is recommended that the boiler and burner be serviced by a qualified heating contractor. Service contracts may be established through gas suppliers or other licensed contractors in your area.

WARNING

As there are no user-serviceable parts on the boiler, burner or control, the end-user must not perform service activities or adjustments of any kind on system components. Failure to heed this warning can cause property damage, severe personal injury, or loss of life.

WARNING

Improper installation, adjustment, service, or maintenance can cause flue products to flow into living space. Flue products contain poisonous carbon monoxide gas which can cause nausea or asphyxiation resulting in severe personal injury or loss of life.

CAUTION

Should overheating occur or the gas supply fail to shut off, do not disconnect the electrical supply to the pump. Instead, shut off the gas supply at a location external to the appliance.

WARNING

The operator/ultimate owner is required to have the heating boiler, burners, and controls checked, as a minimum once per year, by the original installer or by a competent heating contractor familiar with the equipment. Defects must be corrected immediately.

CAUTION

Do not use this boiler if any part has been under water. Immediately call a qualified heating contractor to inspect the boiler and to replace any part of the control system and any gas control which has been under water.

For your Safety *(continued)*

Frozen water pipe hazard

Your heating boiler is designed to provide a warm and comfortable living environment. It is not designed to ensure against freezing of water pipes. The boiler is equipped with several safety devices that are designed to shut down the boiler and to prevent it from restarting in the event of various unsafe conditions.

If your boiler remains off for an extended period of time during cold weather, water pipes may freeze and burst, resulting in extensive water damage and conditions in which mold could grow. Certain molds are known to cause respiratory problems, as well as to pose other serious health risks. In case of water damage, immediate measures should be taken to dry out affected areas as quickly as possible to prevent mold from developing.

If your home will be unattended for an extended period of time during cold weather, you should...

- Shut off the water supply to the building, drain the water pipes and add an antifreeze for potable water to drain traps and toilet tanks. Open faucets where appropriate.

Or..

- Have someone check the building frequently during cold weather and call a qualified service agency if required.

Or...

- Install a reliable remote temperature sensor that will notify somebody of freezing conditions within the home.

! WARNING

Failure to protect against frozen pipes could result in burst water pipes, serious property damage and/or personal injury. Boiler may shut down. Do not leave your home unattended for long periods of time during freezing weather conditions without turning off the water supply and draining water pipes or otherwise protecting against the risk of frozen pipes.

Replacement components, spare and wear parts

IMPORTANT

Components which are not tested with the heating system may damage the heating system or affect its functions. Installation or replacement may only be performed by a qualified heating contractor.

Installation area conditions

! WARNING

Incorrect ambient conditions can lead to damage to the heating system and put safe operation at risk.

Ensure ambient temperatures are higher than 32°F (0°C) and lower than 104°F (40°C).

- Prevent the air from becoming contaminated by halogenated hydrocarbons (e.g. as contained in paint solvents or cleaning fluids) and excessive dust (e.g. through grinding or polishing work). Combustion air for the heating process, and ventilation of the boiler room must be free of corrosive contaminants. To that end, any boiler must be installed in an area that has no chemical exposure. The list below indicates the main, currently known sources.
- Avoid continuously high levels of humidity (e.g. through frequent drying of laundry).
- Never close existing ventilation openings.

Sources of combustion and ventilation air contaminants

Areas likely to contain contaminants:

- New building construction
- Swimming pools
- Remodelling areas, hobby rooms
- Garages with workshops
- Furniture refinishing areas
- Dry cleaning/laundry areas and establishments
- Auto body shops
- Refrigeration repair shops
- Metal fabrication plants
- Plastic manufacturing plants
- Photo processing plants
- Beauty salons

Products containing contaminants:

- Chlorine-type bleaches, detergents and cleaning solvents found in household laundry rooms
- Paint and varnish removers
- Hydrochloric acid, muriatic acid
- Chlorine-based swimming pool chemicals
- Spray cans containing chlorofluorocarbons
- Chlorinated waxes and cleaners
- Cements and glues
- Refrigerant leaks
- Calcium chloride used for thawing
- Sodium chloride used for water softening salt
- Permanent wave solutions
- Adhesives used to fasten building products and other similar items
- Antistatic fabric softeners used in clothes dryers

Commissioning

The commissioning and matching of the control unit to local conditions and building characteristics, as well as instructing the user in the operation of the system, must be carried out by your heating contractor.

Terminology

To provide you with a better understanding of the functions of your Vitotronic control unit some terminology is explained.

The terms are marked as follows:

Further information can be found in the "Terminology" section.

Your System is Preset at the Factory

Your heating system is preset factory preset to 'Heating and DHW' and is therefore ready for use.

Central heating

- Constant 24 h, the rooms are heated to 68°F (20°C) "Room temp setpoint" (standard heating mode).
- Reduced room temperature, the rooms are heated to 64°F (18°C) "Red. room temp setpoint" (reduced room temperature, frost protection when used with time program).
- Your heating contractor can make further settings for you during commissioning. You can change any settings individually at any time to suit your requirements (see "Central heating").

Time and date

- The day and time were set by your heating contractor during commissioning.

Power failure

- All settings are saved if there is a power failure. If the heating system has been powered off for a prolonged period, reset the date and time (refer to page 28).

DHW heating

- Constant 24 h, the DHW tank is heated to 122°F (50°C) "Set DHW temperature". Any installed DHW recirculation pump is on. Set time program for night setback.

Frost protection

- Your boiler and DHW tank are protected against frost.

Wintertime/summertime changeover

- This changeover is automatic.

Energy Saving Tips

Central heating

- Standard room temperature ("Room temp setpoint", refer to page 20):
Never overheat your home. Every degree of room temperature reduction saves up to 6% on your heating bills.
Never set your standard room temperature higher than 68°F (20°C).
- Time program (refer to page 17):
Heat your rooms to the standard room temperature during the day and the reduced temperature at night. Set the time program for this.
- Operating program:
If you do not require central heating, select one of the following operating programs:
 - "Only DHW" (refer to page 24):
If you require no heating for your home in summer, but you need hot water.
 - "Standby mode" (refer to page 21):
If you don't need to heat your home and don't need hot water for longer periods.
- Short absence (refer to page 22):
Reduce the room temperature if you are going shopping, for example. For this, select "Economy mode".
- Holidays (refer to page 23):
If you are going away, select the "Holiday program":
The room temperature will be reduced, and DHW heating will be turned off.
- Ventilation:
To ventilate, close the thermostatic valves and open the windows fully for a short time.
- Roller shutters:
Close roller shutters (where installed) at dusk.
- Thermostatic valves:
Ensure that thermostatic valves are properly set.
- Radiators:
Never cover radiators or thermostatic valves.

DHW heating

- DHW recirculation pump (refer to page 25):
Only activate the DHW recirculation pump for periods in which DHW is regularly drawn off. Set the time program for this.
- DHW consumption:
Consider showering instead of running a bath. A shower generally uses less energy than a full bath. For additional energy saving functions of the Vitocrossal 300 CU3A, please contact your heating contractor.

Tips for More Comfort

DHW heating

- Time program (refer to pages 15 and 27):
Use the time program for DHW heating.
Use the time program for the DHW recirculation pump.
During the selected time phases, DHW will be available at the draw-off points at the required temperature.

Central heating

- Standard room temperature ("Room temp setpoint", refer to page 20):
You can select your desired temperature at any time in the standard menu.
- Primary heating circuit (refer to page 28):
If your heating system consists of several heating circuits, you can make the most important adjustments for a primary heating circuit directly via the standard menu.
- Time program (refer to page 17):
Make use of the time program. In the time program, you can set time phases with different room temperatures, for example different temperatures for day and night time.
- Heating curve (refer to page 21):
The heating curve enables you to individually adjust the heating system to the actual heat demand in your home. If set correctly, your desired temperature will be achieved all year round.
- "Party mode" (refer to page 22):
Select "Party mode" if you want to heat your home to a temperature that is different from that dictated by the time program.
Example: The time program determines that in the evening, your home is heated to a reduced room temperature, but you have visitors staying into the evening.

Opening the Control Unit

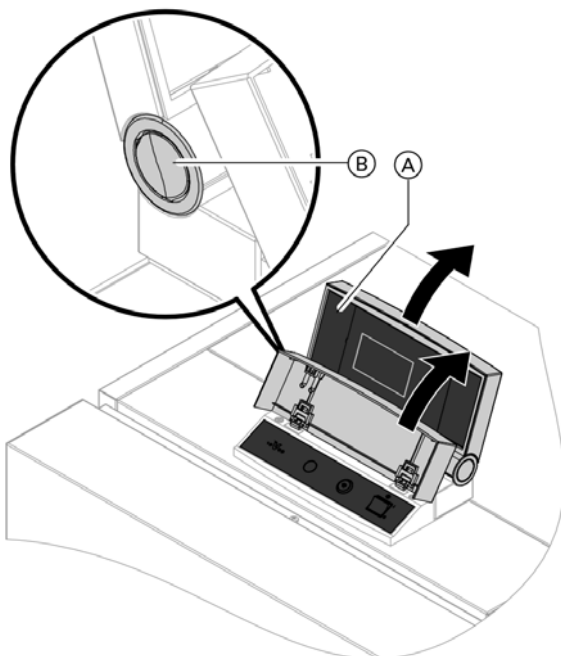

Vitotronic 200, type KW6B

Legend

- Ⓐ Top part of control unit with programming unit
- Ⓑ Pushbutton for changing the angle

Overview of Controls

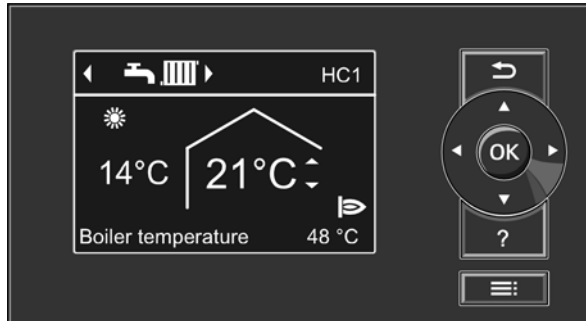

Modular structure

The control unit is integrated into the boiler. The control unit comprises a standard unit, electronics modules and a programming unit.

Standard unit:

- ON/OFF switch
- Optolink laptop interface
- Operating and fault indicators
- Reset button
- Fuses



Programming unit (HO1B):

- Easy operation through:
 - Plain text display with graphic ability
 - Large font and black & white depiction for good contrast
 - Context-sensitive help text
- With digital time switch
- Control keys for:
 - Navigation
 - Confirmation
 - Help and additional information
 - Menu
- Setting the:
 - Standard room temperature
 - Reduced room temperature
 - DHW temperature
 - Heating program
 - Time programs for central heating, DHW heating and DHW recirculation
 - Economy mode
 - Party mode
 - Holiday program
 - Heating curves
 - Coding addresses
 - Actuator tests
 - Test mode
- Displaying the:
 - Boiler water temperature
 - DHW temperature
 - Operating details
 - Diagnostic details
 - Fault messages

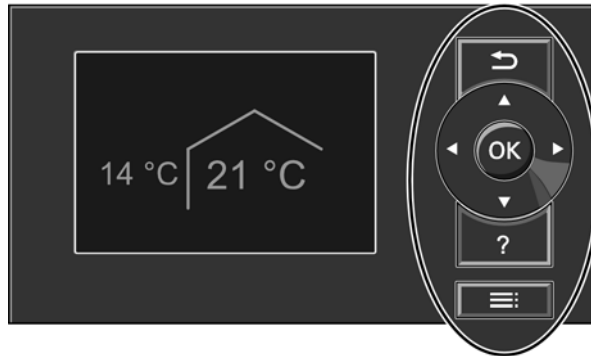
Programming Unit



Legend

-  Takes you to the previous step in the menu or cancels a setting that has been started
-  Cursor keys To scroll through the menu or to set values
- OK Confirms your selection or saves the setting
- ? Calls up help or additional information on the selected menu.
-  Calls up the extended menu

You can change any settings on your heating system centrally at the programming unit of the boiler control unit.

If remote control units are installed in your rooms, you can also adjust the settings at the remote control units.



Refer to the remote control operating instructions

Two control levels are available:

- The standard menu: Refer to page 14.
- The extended menu: Refer to page 14.

Note: The screen saver is activated if you have not made any adjustments on the programming unit for a few minutes (refer to page 15).

“Help” menu

Displays explanations about operation in the form of a short guide.







Call up the short guide as follows:

- If the screen saver is active (refer to page 15):
Press ?.
- From anywhere in the menu:
Keep pressing the  key until the standard menu is displayed (refer to page 14).
Press ?.

Symbols

These symbols are not always displayed, but appear subject to the system version and the operating state.

Indicators:

-  Frost protection enabled
-  Central heating to standard room temperature
-  Central heating with reduced room temperature
-  Party mode enabled
-  Economy mode enabled
-  In conjunction with a solar thermal system:
Solar circuit pump is running

Heating circuits:

Heating circuit ...

Operating programs:



For an explanation of the symbols (refer to page 16).

Messages:

 Fault

 Service

Standard Menu

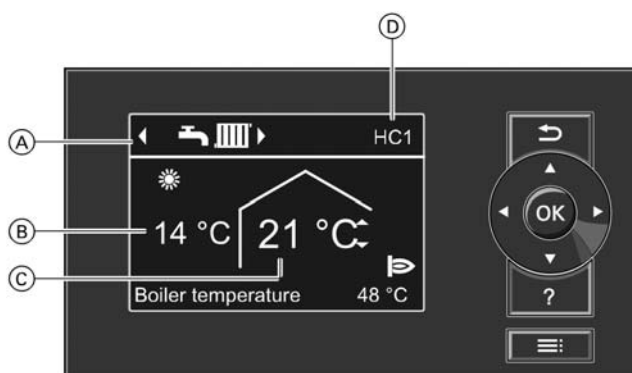

Legend

- Ⓐ Header (shows the operating program for displayed heating circuit Ⓓ)
- Ⓑ Current outside temperature
- Ⓒ Set room temperature
- Ⓓ Heating circuit which is selected for operation in the standard menu (primary heating circuit)

The following settings for the primary heating circuit Ⓓ can be called up and adjusted in the standard menu:

- Standard room temperature
- Operating program
Call up the standard menu as follows:
 - If the screen saver is active (refer to page 15): Press OK.
 - If you are in the extended menu: Keep pressing the ↩ button until the standard menu appears.

- Note:**
- Settings for the primary heating circuit can also be adjusted in the extended menu
 - The settings for any other connected heating circuits can only be adjusted in the extended menu.
 - Your heating contractor can block the operation of the standard menu. In such cases, you will not be able to make adjustments in either the standard menu or in the extended menu.

Setting the standard room temperature for the primary heating circuit (displayed in the header Ⓓ)

Press the following keys:
▲/▼ for the required value.
OK to confirm.

Setting the operating program for the primary heating circuit (displayed in the header Ⓓ)

Press the following keys:
◀▶ for the required operating program.
OK to confirm.

Extended Menu

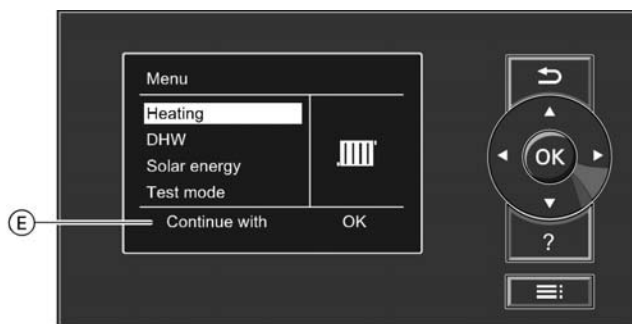

Legend

- Ⓔ Dialogue line

In the extended menu, all settings for the Vitotronic control unit's range of functions can be called up and adjusted, including for example adjustments to the holiday program and time programs.

The menu overview can be found on page 38.

Call up the extended menu as follows:

- If the screen saver is active (refer to page 15): Press OK and then ≡.
- From anywhere in the menu: Press ≡.

Note: Your heating contractor can block access to the extended menu. In this case, you can only call up service and fault messages.

How to Use the Controls

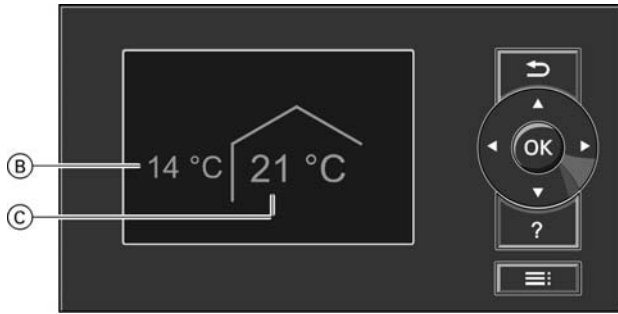

Legend

- (B) Current outside temperature
- (C) Standard room temperature

The screen saver will become active if you have not adjusted any settings on the programming unit for a few minutes. The display brightness is reduced.



1. Press OK. This takes you to the standard menu (refer to page 14).
2. Press ≡: This takes you to the extended menu (refer to page 14). The selected menu option is highlighted in white. The dialogue line (E) (refer to diagram on page 14) then shows the necessary instructions.

Adjustments to the central heating can be made for every heating circuit. It is therefore necessary to select the respective heating circuit prior to making any adjustments (e.g. standard room temperature). The following diagram shows how to make adjustments, using the standard room temperature as an example. The diagram shows the adjustment without and with selection of the heating circuit, as well as different dialog lines.



Operating Program

Operating programs for central heating, DHW, frost protection

Symbol	Operating program	Function
	"Heating and DHW"	<ul style="list-style-type: none"> ■ The rooms of the selected heating circuit are heated in accordance with the room temperature and time program specified (see section "Central heating"). ■ DHW is heated in accordance with the DHW temperature and time program specified (see section "DHW heating").
	"Only DHW"	<ul style="list-style-type: none"> ■ DHW is heated in accordance with the DHW temperature and time program specified (see section "DHW heating"). ■ No central heating. ■ Frost protection enabled.
	"Standby mode"	<ul style="list-style-type: none"> ■ No central heating. ■ No DHW heating. ■ Frost protection for the boiler and the DHW tank is active.

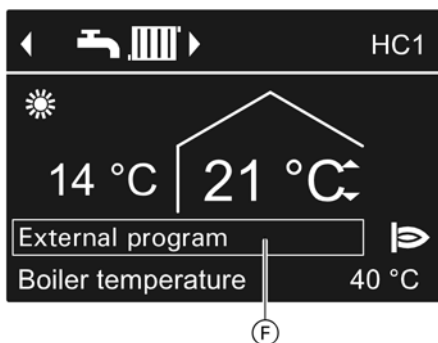

Legend

(F) Special operating programs

Special operating programs

"External hook-up"

Your heat pump control unit is regulated by a higher control unit.

"External program"

The operating program was changed by a communications interface (e.g. Vitocom 100).

"Holiday program"

Refer to page 23.

Note: In the extended menu, you can call up the set operating program under "Information" (refer to page 39).

With frost protection monitoring

For every heating circuit select the "Standby mode" operating program

- No central heating
- No DHW heating
- Frost protection for the boiler and the DHW tank is active.

Single boiler system control: Refer to page 20

Without frost protection monitoring (shutdown)

When the boiler control and accessories are de-energized, frost protection is not active for the boiler or the DHW tank.

IMPORTANT

If outdoor temperatures of below 37°F (3°C) are expected, take appropriate measures to protect the heating system from frost.

If necessary, contact your heating contractor.

Information on a prolonged shutdown

- Circulation pumps may seize up as they are not being supplied with power.
- It may be necessary to reset the date and time (refer to page 28).

Time Program

Example of time phases within the time program for central heating

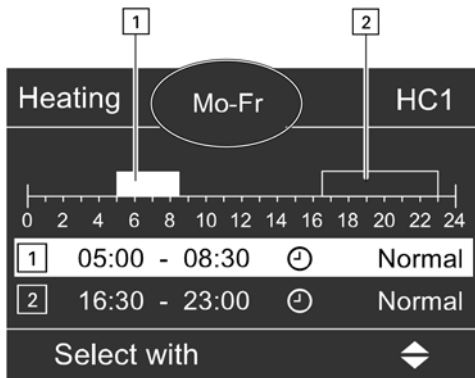

- Time program for the following part of the week: "Monday–Friday" ("Mo-Fr")
- Time phase 1: 05:00 to 08:30 h
- Time phase 2: 16:30 to 23:00 h

In between these time phases the system heats to a reduced temperature.

The following explains how to input the settings for a time program. The special features of each individual time program are assigned to the relevant chapters.

Setting a time program for the following functions:

- Central heating (refer to page 20)
- DHW heating (refer to page 25)
- DHW recirculation pump (refer to page 25)
- You can set the time program individually, to be the same for every day of the week or different: You can select up to 4 time phases per day for standard heating mode. Set the start and end points for each time phase. Between these time phases, the rooms are heated with the reduced room temperature (see chapter "Setting the room temperature for reduced heating mode").
- When setting, bear in mind that your heating system requires some time to heat the rooms to the required temperature.
- You can set the time program individually, to be the same, or different, for every day of the week.
- You can select up to 4 time phases per day.
- For each time phase you will need to select the start and end points. The selected time phase is illustrated by a white bar on the time chart. The length of the bar reflects the length of time.
- In the extended menu, you can call up the time programs under "Information" (refer to page 39).

Setting a time program using central heating as an example

Extended menu:

- 1.
2. "Heating"
3. Poss. for the required heating circuit.
4. "Heating time program"
5. Select part of the week or a day.
6. Select a time phase 1 to 4. The selected time phase is illustrated by a white bar on the time chart.
7. Set the start and end points for the relevant time phase. The length of the white bar in the time diagram is adjusted accordingly.
8. Press to exit the menu.

Note: If you want to terminate a time phase setting process prematurely, keep pressing until the required display appears.

Time Program *(continued)*

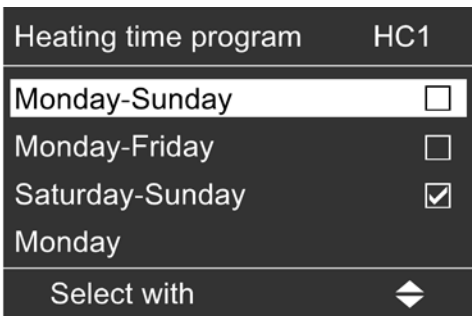
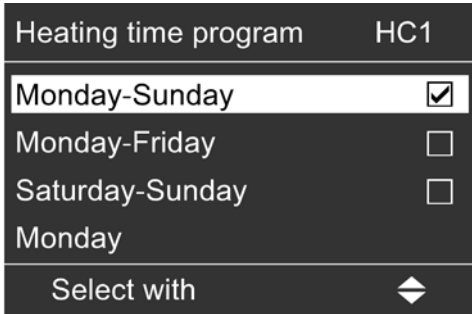

Setting the time program efficiently

If you would like to set a different time program for just one day of the week, proceed as follows:

Example: You want to set a different time program for Monday:

1. Select the period "Monday–Sunday" and set the time program.
Note: The check mark is always set at the sections of the week with identical time phases.
 Factory setting: Same for all days of the week, therefore "Monday-Sunday" is checked.

2. Then select "Monday" and adjust the time program for that day.
Note: The "Saturday-Sunday" part of the week is checked because the set time phases correspond only to this part of the week.

Deleting time phases

- Set the time for the end point to the same time that was set for the start point.
- Or
- For the start point, select a time prior to 00:00 h. The display shows the selected time phase as "--:--".

Starting the Heating System

Vitotronic 200, type KW6B

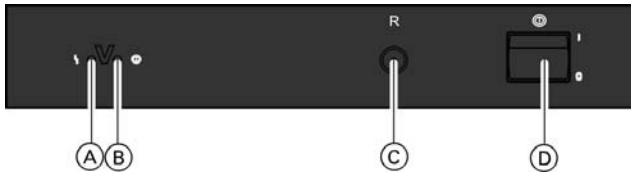

Legend

- (A) Fault indicator (red)
- (B) On indicator (green)
- (C) Reset button
- (D) ON/OFF switch

Ask your heating contractor about the following:

- Boiler type and relevant control unit type
 - Required system pressure
 - Location of the pressure gauge, shut-off valve, gas shut-off valve, ventilation apertures
1. Check the heating system pressure at the pressure gauge. If the pressure of the heating system is too low, top up the water or notify your heating contractor.
 2. In boilers for room air dependant operation: Check that the ventilation apertures of the mechanical room are open and unrestricted.
 3. Open the gas shut-off valve(s).
 4. Switch ON the power supply, e.g. at a separate MCB/fuse or a mains isolator.
 5. Switch ON the ON/OFF switch

After a short time, the standard menu is displayed (refer to page 14) and the green ON indicator illuminates. Your heating system and, if installed, your remote control unit are now ready for use.

Shutting Down the Heating System

With frost protection monitoring

For every heating circuit, select heating program "Standby mode".

- No central heating.
- No DHW heating.
- Frost protection for the boiler and the DHW tank is enabled.

For the primary heating circuit (displayed in the header)

Standard menu

1. ►/◄ for the operating program OK to confirm

For all heating circuits

Extended menu

1. ≡:
2. "Heating"
3. Poss. ►/◄ for the required heating circuit.
4. "Operating program"
5. "Standby mode"

Pump exercise function

Circulation pumps are started for 10 sec. once every 24 hours to prevent the pumps from seizing up. This function is active during all operating programs and during warm weather shutdown.

Ending the heating program "Standby mode"

Select another heating program.

Without frost protection monitoring

1. Switch the ON/OFF switch OFF.
2. Close the shut-off valves.
3. Isolate the heating system from its main power supply, e.g. at a separate MCB/fuse or a mains isolator.
4. Where outside temperatures of below 37°F (3°C) are anticipated, please take suitable measures to protect the heating system against frost. If necessary, contact your heating contractor.

Information on an extended shutdown

- Circulation pumps may seize up if they are not supplied with power.
- After an extended shutdown, it may be necessary to reset the date and time (refer to page 28).

Room Temperature

Further information can be found in "Terminology" page 40.

Setting the standard room temperature for central heating

Factory setting: 68°F (20°C)

For the primary heating circuit (refer to page 28)

Standard menu

1. ▲▼ for the required value.
2. OK to confirm.

For all heating circuits

Extended menu

1. ≡:
2. "Heating"
3. Poss. ◀▶ for the required heating circuit.
4. "Room temp setpoint"
5. Set the required value.

Setting the reduced room temperature for central heating (night setback)

Factory setting: 64°F (18°C)

Extended menu

1. ≡:
2. "Heating"
3. Poss. ◀▶ for the required heating circuit.
4. "Reduced room temp setpoint"
5. Set the required value.

Central heating to this temperature:

- Between the time phases for standard heating mode.
- In the holiday program (refer to page 23).

Setting the Operating Program for Central Heating

Further information can be found in "Terminology" page 40.

Setting the operating program for central heating

For the primary heating circuit (refer to page 28)

Standard menu

1. ◀▶ for the operating program:
"Heating and DHW"
2. OK to confirm.

For all heating circuits

Extended menu

1. ≡:
2. "Heating"
3. Poss. ◀▶ for the required heating circuit.
4. "Operating program"
5. For example "Heating and DHW"

For information on the operating programs, refer to page 16.

Time Program

Further information can be found in "Terminology" page 40.

Setting the time program for central heating

Factory setting: One time phase from 0:00 to 24:00 h for every day of the week.

Extended menu:

1. ≡:
2. "Heating"
3. Poss. ◀▶ for the required heating circuit.
4. "Heating time program"
5. Set the required time phases.

Procedure for setting a time program, refer to page 17.

Note: When setting, bear in mind that your heating system requires some time to heat the rooms to the required temperature.

Heating Curve

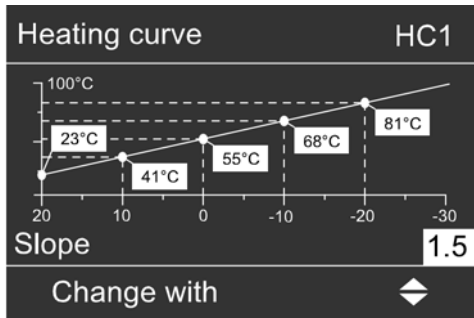

Example: Changing the heating curve slope to 1.5
A graph clearly shows the change in the heating curve as soon as you alter the value for the slope or shift.

Depending on various outside temperatures (shown on the horizontal axis), the assigned set supply temperatures for the heating circuit are highlighted in white.

Your system's heating characteristics are affected by the slope and the shift of the selected heating curve. Further information about the heating curve can be found under "Terminology" on page 40.

Factory setting:



- Slope: 1.4
- Heating curve shift: 0
- Standard room temperature (set value): 68°F (20°C)
- Reduced room temperature (set value): 64°F (18°C)

Setting the heating curve

Factory setting:

- "Slope": 1.4
- "Shift" of the heating curve: 0

Extended menu:



1. ;
2. "Heating"
3. Poss.   for the required heating circuit.
4. "Heating curve"
5. "Slope" or "Shift"
6. Set the required value.

Note: Tips on when and how to change the heating curve slope and shift are displayed by pressing ?.

End Central Heating



For the primary heating circuit (refer to page 28)

Standard menu

1.   for the operating program:
"Only DHW" (no central heating)
Or
"Standby mode" (frost protection active)
2. OK to confirm.

For all heating circuits

Extended menu

1. ;
2. "Heating"
3. Poss.   for the required heating circuit.
4. "Heating program"
5. "Only DHW" (no central heating)
Or
"Standby mode" (frost protection active)

Comfort Function "Party Mode"

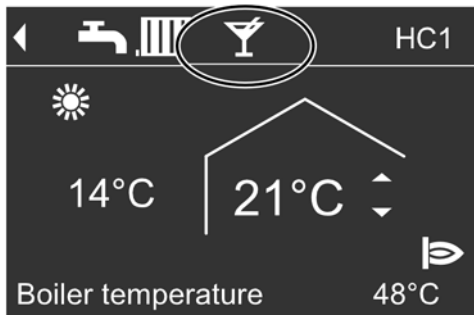
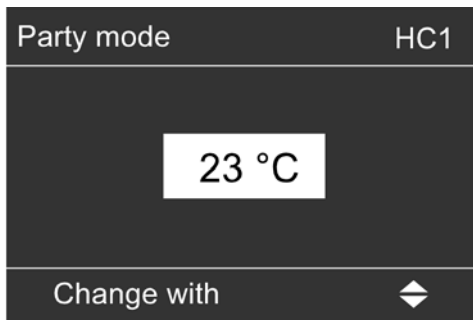

Display in the standard menu

Selecting the comfort function "Party mode"

With this function, you can change the room temperature for several hours, e.g. if guests unexpectedly stay longer in the evening. You do not have to change any existing control settings. The DHW is reheated in this function to the selected set temperature.

Setting "Party mode" for central heating

Extended menu

1. ☰:
2. "Heating"
3. Poss. ⬅➡ for the required heating circuit.
4. "Party mode"
5. Set the required room temperature for "Party mode".

Note: The display of the set standard room temperature does not change.

- The rooms are heated to the required temperature.
- Provided your heating contractor has not altered the settings, DHW is heated to the selected set temperature first, before central heating begins.
- The DHW recirculation pump is switched ON (if installed).

Cancelling "Party mode"

- Automatically after 8 hours.

Note: If you want to make changes to this, contact your local heating contractor.

Or

- Automatically when the system switches to standard heating mode in accordance with the time program.

Or

- Set "Party mode" to "OFF".

Energy Saving Function "Economy Mode"

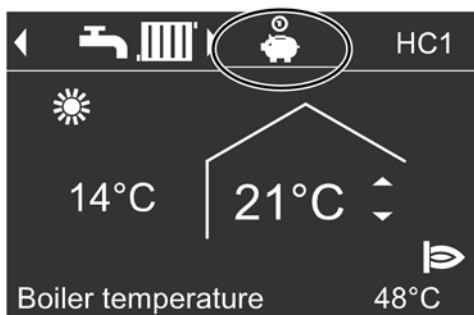

Selecting the energy saving function "Economy mode"

To save energy, you can reduce the room temperature in standard heating mode. For example, if you leave the house for a few hours.

Setting "Economy mode" for central heating

Extended menu

1. ☰:
2. "Heating"
3. Poss. ⬅➡ for the required heating circuit.
4. "Economy mode"

Note: The display of the set room temperature does not change.

Cancelling "Economy mode"

- Automatically when the system switches to reduced heating mode in accordance with the time program.

Or

- Set "Economy mode" to "OFF".

Energy Saving Function "Holiday Program"

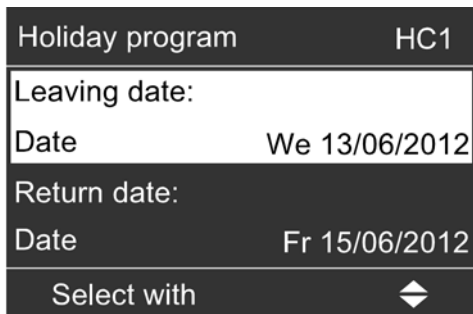
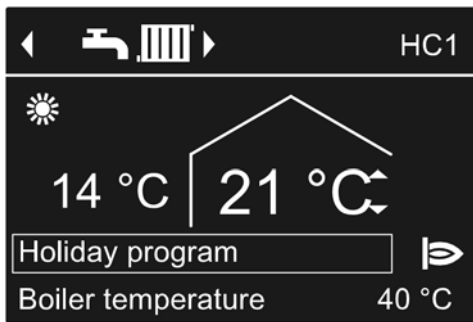

Display in the standard menu

Selecting the energy saving function "Holiday program"

To save energy, for example over long holidays, you can activate the "Holiday program".

Setting the "Holiday program" for central heating

Note: The holiday program affects all heating circuits.
If you want to make changes to this, contact your local heating contractor.

The holiday program starts at 00:00 h on the day following your departure and ends at 00:00 h on the day of your return. This means the selected time program is active on the days of departure and return (refer to page 20).

Extended menu:

1. ☰:
2. "Heating"
3. "Holiday program"
4. Set the required departure and return dates.

The holiday program has the following effect:

- Central heating:
 - For heating circuits in the operating program "Heating and DHW":
The rooms are heated to the selected reduced room temperature (refer to page 20).
 - For heating circuits in the operating program "Only DHW":
No central heating. Frost protection for the boiler and the DHW tank is active.
- DHW heating:
There is no DHW heating while 'holiday program is active. Frost protection for the DHW tank is active.

Display in the extended menu

In the extended menu, you can call up the set holiday program under "Information" (refer to page 39).

Cancelling or deleting the "Holiday program"

Extended menu

1. ☰:
2. "Heating"
3. "Holiday program"

Setting the DHW Temperature

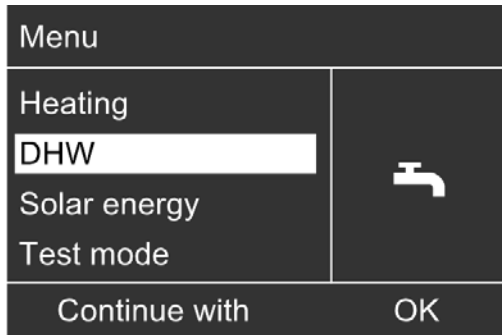

Factory setting 122°F (50°C)

Extended menu:

1. ☰:
2. "DHW"
3. "DHW temperature setpoint"
4. Using ◀▶ set the required value
5. Ok to confirm

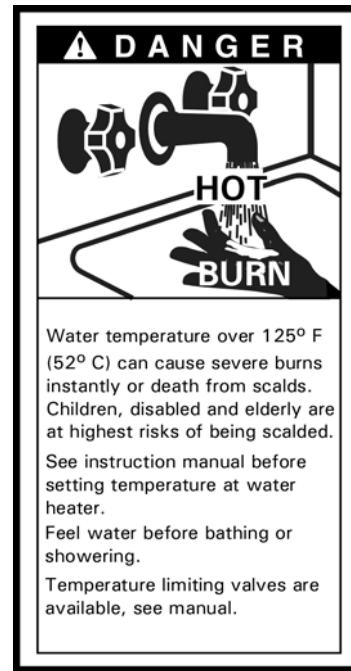

Operating Program

Further information can be found in "Terminology" page 40.

Setting the operating program for DHW heating

For the primary heating circuit (refer to page 28)

Standard menu

1. ◀▶ for the operating program:
"Heating and DHW"
Or
"Only DHW"

2. OK to confirm.

For all heating circuits

Extended menu

1. ☰:
2. "Heating"
3. Poss. ◀▶ for the required heating circuit.
4. "Heating program"
5. "Heating and DHW"
Or
"Only DHW" (summer mode no central heating)

For information on the operating programs (refer to page 16).

Time Program

Further information can be found in "Terminology" page 40.

Setting the time program for DHW heating

Factory setting: One time phase from 00:00 to 24:00 h for every day of the week.

Extended menu:

1. 
2. "DHW"
3. "DHW time program"
4. Set the required time phases.

Procedure for setting a time program, refer to page 17.

Note: Between the time phases, DHW is not heated; only frost protection for the DHW tank is active. When setting time programs, please bear in mind that your heating system requires some time to heat the DHW tank to the required temperature.

DHW heating outside of the time program

Note: The operating program "Heating and DHW" or "Only DHW" must be set for at least one system heating circuit.

Extended menu

1. 
2. "Heating"
3. "Party mode"
4. Disable "Party mode" again with "OFF" to prevent unintentional central heating with standard room temperature.

Setting the time program for the DHW recirculation pump

The time program for the DHW recirculation pump is preset to Automatic mode at the factory. In other words, the DHW recirculation pump operates in parallel to the DHW heating time program.

- If you don't want the automatic mode, you can select up to 4 individual time phases per day for the DHW recirculation pump, which can be the same for every day of the week or different. Set the start and end points for each time phase.
- In the "Information" menu, you can scan the current time program (see chapter "Scanning information", "DHW" group).

Note: Activating the DHW recirculation pump is only advisable for those times when DHW is actually drawn.

Extended menu:

1. 
2. "DHW"
3. "DHW circ time prog"
4. Set the required time phases.

Procedure for setting a time program, refer to page 17.

Note: Between time phases the DHW recirculation pump remains off.

Switching Off DHW Heating

You do not want to heat DHW or provide central heating	You do not want to heat DHW, but do want to provide central heating
<p>For the primary heating circuit (refer to page 28) Standard menu</p> <ol style="list-style-type: none"> 1. ◀▶ for the operating program "Standby mode" (frost protection is active). 2. OK to confirm. 	<p>--</p>
<p>For all heating circuits Extended menu</p> <ol style="list-style-type: none"> 1. ≡: 2. "Heating" 3. Poss. ◀▶ for the required heating circuit. 4. "Heating program" 5. "Standby mode" (frost protection active) 	<p>Extended menu</p> <ol style="list-style-type: none"> 1. ≡: 2. "Heating" 3. Poss. ◀▶ for the required heating circuit. 4. "Heating program" 5. "Heating and DHW" 6. ↶ until the menu is displayed. 7. "DHW" 8. "Set DHW temperature" 9. Set 50°F (10°C).

Setting the Display Contrast

Extended menu

1. ☰
2. "Settings"
3. "Contrast"
4. Set the required contrast.

Setting the Display Brightness

If you would like the texts in the menu to be more clearly legible, change the brightness for "Control". You can also alter the screen saver brightness.

Extended menu

1. ☰
2. "Settings"
3. "Brightness"
4. "Control" or "Screen saver"
5. Set the required brightness.

Entering Names for the Heating Circuits

Example: Name for "Heating circuit 2": Apartment

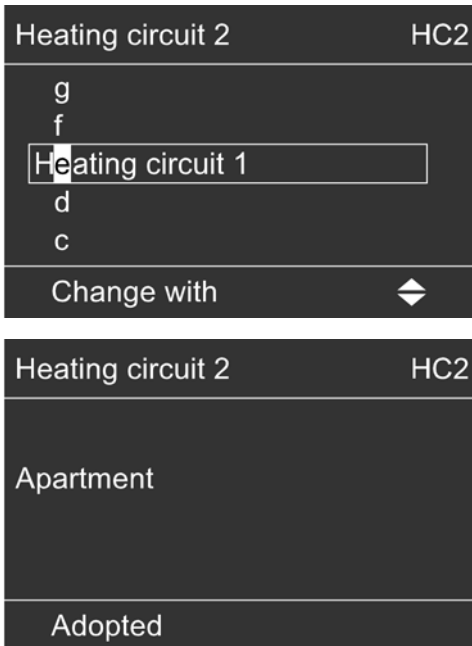

You can name all heating circuits individually. The abbreviations "HC1", "HC2" and "HC3" will be retained.

Extended menu

1. ☰
2. "Settings"
3. "Name for heating circ."
4. "Heating circuit 1", "Heating circuit 2" or "Heating circuit 3"
5. "Change?"
6. You can select the required symbol with ▲/▼.
7. ⬅️ takes you to the next character.
8. Press OK to accept all entered characters at once and simultaneously exit this menu.

Note: You can delete the name entered with "Reset?".

The menu shows "Apartment" for "Heating circuit 2".

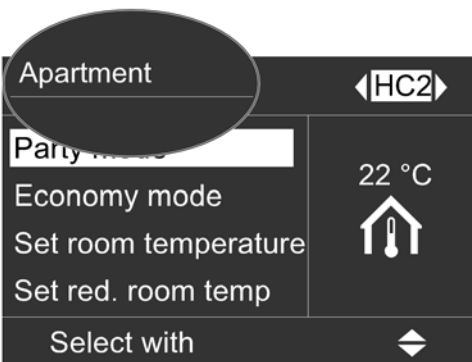

Setting the Primary Heating Circuit for the Standard Menu

If your heating system has several heating circuits, you can select the heating circuit to be displayed in the standard menu.

Extended menu

1. 
2. "Settings"
3. "Standard menu"
4. Select the heating circuit:
 - "Heating circuit 1" (for heating circuit 1)
"HC1" is displayed
 - "Heating circuit 2" (for heating circuit 2)
"HC2" is displayed
 - "Heating circuit 3" (for heating circuit 3)
"HC3" is displayed

Setting the Time and Date

The time and date are factory-set. If your heating system has been without power for a long time, it may be necessary to set the time and date.



Extended menu:

1. 
2. "Settings"
3. "Time/Date"
4. Set the time and date.

Language Selection

Sprache	
Deutsch	DE <input checked="" type="checkbox"/>
Cesky	CZ <input type="checkbox"/>
Dansk	DK <input type="checkbox"/>
American English	EUS <input type="checkbox"/>
Wählen mit 	

Extended menu:

1. 
2. "Settings"
3. "Language"
4. Select the required language with /
5. Accept by pressing OK.

Setting the Temperature Unit °F (°C)

Factory setting: °C

Extended menu:

1. 
2. "Settings"
3. "Temperature unit"
4. Select the temperature unit "°C" or "°F".

Restoring Factory Settings

You can reset the factory settings of all modified values for each heating circuit separately.

Extended menu:

1. 
2. "Settings"
3. "Standard setting"
4. "Heating circuit 1", "Heating circuit 2" or "Heating circuit 3"

System setting	Settings and values that are reset
"Heating circuit 1", "Heating circuit 2" or "Heating circuit 3"	<ul style="list-style-type: none"> ■ Set room temperature: 68°F (20°C) ■ Set reduced room temperature ■ Operating program ■ Set DHW temperature ■ Time program for central heating ■ Time program for DHW heating ■ Time program for DHW recirculation pump ■ Heating curve slope and shift ■ Comfort and energy saving functions ("Party mode", "Economy mode", "Holiday program") are deleted. <p>Note: If heating circuits have been named (see chapter "Naming heating circuits") the assigned name is retained.</p>

Scanning Information

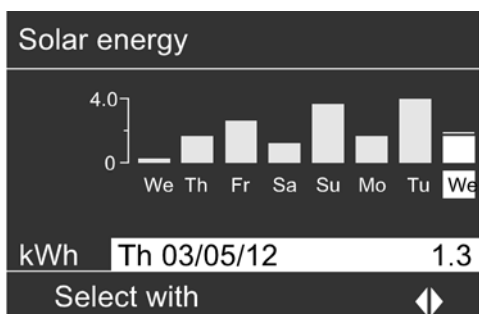

Subject to the connected components and settings made, you can scan current temperatures and operating conditions.

The extended menu splits the information into groups:

- "General"
- "Heating circuit 1"
- "Heating circuit 2"
- "Heating circuit 3"
- "DHW"
- "Solar"
- "Reset data"

Note: If heating circuits have been named, the name is displayed (see section "Entering names for the heating circuits"). Detailed options for calling up data on individual groups can be found in chapter "Calling up options under information".

Extended menu:

- 1.
2. "Information"
3. Select the group.
4. Select the required information.

Calling up the solar yield in conjunction with solar thermal systems

Extended menu:

- 1.
2. "Solar energy"

The solar energy yield is shown in diagrammatic form. The flashing line on the graph indicates that the current day is not yet over.

Note: Further options for calling up data, e.g. for the solar circuit pump hours run, can be found in the extended menu under "Information" in the "Solar" group.

Resetting data

You can reset the following data:

- Burner hours run.
- Fuel consumption.
- In conjunction with a solar thermal system: Solar energy yield, solar circuit pump hours run and hours run output 22.
- All the above data simultaneously.

Extended menu:

- 1.
2. "Information"
3. "Reset data"

Scanning the Service Messages

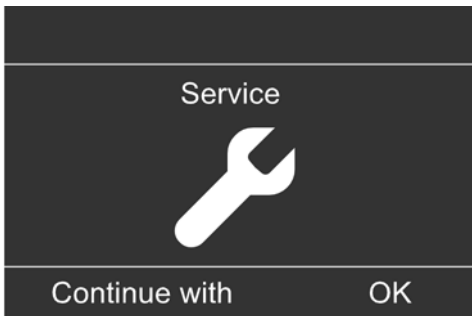

If your heating system is due for a service, the symbol  flashes in the display, and "Service" appears.

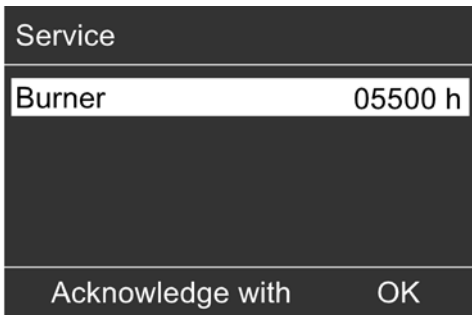

1. You can call up the reason for the service with OK.
2. Pressing ? calls up information on the service that is due.
3. If you want to acknowledge the service message, follow the instructions in the menu. Contact your local heating contractor. The service message is transferred to the menu.

Note: If the service can only be carried out at a later date, the service message is displayed again the following Monday.

Display in the standard menu

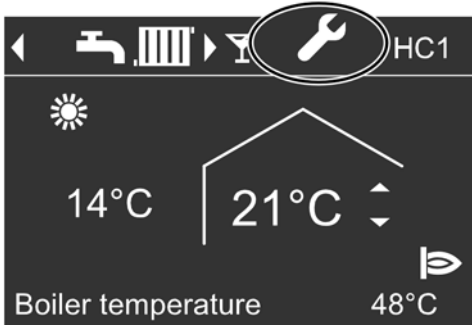

Calling up an acknowledged service message

Extended menu:

1. 
2. "Service"

Display in the extended menu

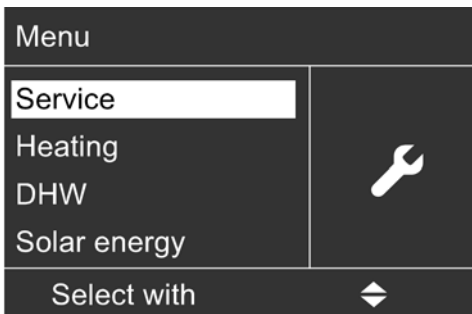

Scanning Fault Messages

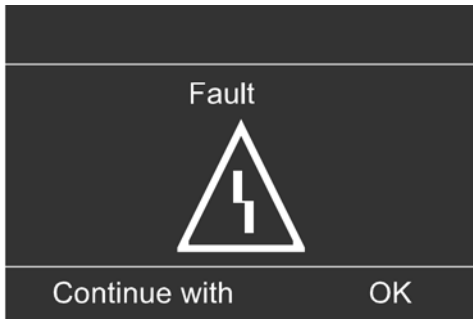

If any faults have occurred in your heating system, the symbol  flashes in the display, and "Fault" appears. The red fault indicator also flashes (see chapter "Starting the heating system").

WARNING

If faults are not rectified, they can have life threatening consequences. Do not acknowledge fault messages several times in quick succession. If a fault occurs repeatedly, notify your heating contractor so the cause can be analyzed and the fault rectified.

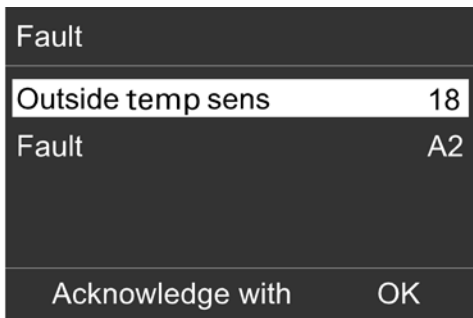

1. You can call up the cause of the fault with OK.
2. Pressing ? calls up information on the heating system performance. Tips on which measures you can take yourself before notifying your heating contractor are also displayed.
3. Make a note of the cause of the fault and the fault code next to it on the right. In this example: "Outside temp sens 18" and "Fault A2". This enables the heating contractor to be better prepared for the service call and may save additional time and costs.
4. If you want to acknowledge the fault message, follow the instructions in the menu. The fault message is transferred to the menu.

Display in the standard menu

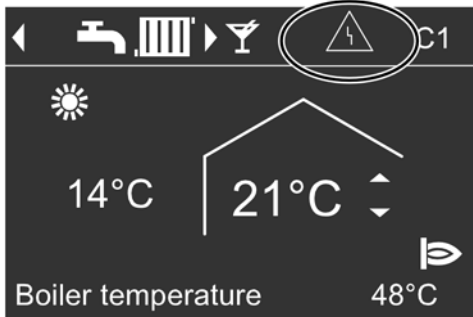

- Note:**
- If you have connected up signalling equipment (e.g. a buzzer) for fault messages, this is deactivated when the fault message is acknowledged.
 - If the fault can only be rectified later, the fault message will be displayed again the next day at 7:00 h, when the signalling equipment (if installed) is switched on again.

Display in the extended menu

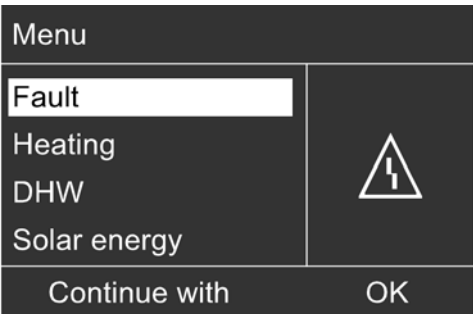

Calling up an acknowledged fault message

Extended menu:

1. :
2. "Fault"

Emissions Test Mode

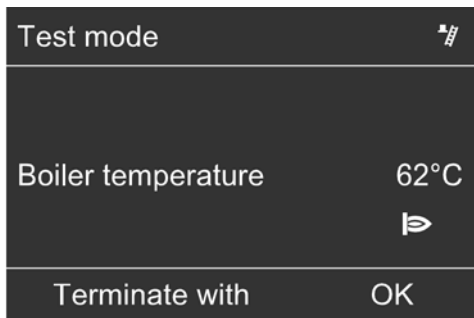

Emissions test mode should only be activated by a certified technician during the annual inspection.

Extended menu:

- 1.
2. "Test mode"
3. "Flue gas test °C ON"

The following functions are activated:

- The burner is switched on (the display shows symbol).

Note: Burner start-up can be delayed, e.g. through fuel oil preheating.



- The pumps are started and the mixing valves remain in control function.
- The temperature controller regulates the boiler water temperature.

Note: You can also enable emissions test mode if the controls are locked out by your heating contractor.

Ending emissions test mode

- Automatically after 30 min.
- Press OK.

Rooms are too Cold

Cause	Remedy
The heating system is off.	<ul style="list-style-type: none"> - Switch the ON/OFF switch ON (refer to diagrams on page 18). - Switch ON the mains isolator, (if installed outside the boiler room). - Reset the MCB in the power distribution board (main domestic MCB).
<ul style="list-style-type: none"> ■ Control unit incorrectly adjusted. ■ Remote control (if installed) set incorrectly.  See separate operating instructions	<p>Central heating must be enabled. Check settings and correct if required:</p> <ul style="list-style-type: none"> - Operating program (refer to page 20) - Room temperature (refer to page 20) - Time (refer to page 28) - Time program central heating (refer to page 20) - Heating curve (refer to page 21)
The DHW tank is being heated.	<p>Wait until the DHW tank has been heated up. Possibly reduce the DHW draw-off rate or temporarily reduce the standard DHW temperature.</p>
No fuel.	<p>With LPG: Check the fuel reserves and re-order if required. With natural gas: Open the gas shut-off valve. If necessary, check with your gas supply utility.</p>
"Fault" is displayed, and the red fault indicator flashes.	<p>Call up and acknowledge the type of fault (refer to page 32). If necessary, notify your heating contractor.</p>
"Slab curing" is active.	<p>No action required. After expiry of the slab curing time, the selected operating program will become active.</p>
"Combustion controller" is shown on the display.	<p>Press R (refer to diagram on page 19). Acknowledge the fault (refer to page 32).</p>
	<div style="border: 1px solid black; padding: 5px;"> <p> WARNING</p> <p>If faults are not rectified, they can have life threatening consequences. Do not acknowledge fault messages several times in quick succession. If a fault occurs repeatedly, notify your heating contractor so the cause can be analyzed and the fault rectified.</p> </div>
"Fault" is displayed and the red fault indicator on the burner is illuminated.	<p>Press the reset button on the burner. If there is no reset button, switch the ON/OFF switch (refer to diagrams from page 18) first OFF and then ON again.</p>
	<div style="border: 1px solid black; padding: 5px;"> <p> WARNING</p> <p>If faults are not rectified, they can have life threatening consequences. Do not acknowledge fault messages several times in quick succession. If a fault occurs repeatedly, notify your heating contractor so the cause can be analyzed and the fault rectified.</p> </div>
Mixing valve motor faulty.	Adjust the mixing valve manually.

Rooms are too Hot

Cause	Remedy
<ul style="list-style-type: none"> ■ Control unit incorrectly adjusted. ■ Remote control (if installed) set incorrectly.  See separate operating instructions	Check settings and correct if required: <ul style="list-style-type: none"> - Operating program (refer to page 20) - Room temperature (refer to page 20) - Time (refer to page 28) - Time program central heating (refer to page 20) - Heating curve (refer to page 21)
"Fault" is displayed, and the red fault indicator flashes.	Scan and acknowledge the type of fault (refer to page 32). If necessary, notify your heating contractor.
Mixing valve motor faulty.	Adjust the mixing valves manually.

There is no Hot Water

Cause	Remedy
The heating system is off.	<ul style="list-style-type: none"> - Switch the ON/OFF switch ON (refer to diagrams on page 19). - Switch ON the mains isolator, if installed (outside the boiler room). - Reset the fuse/MCB in the power distribution board (main domestic fuse/ MCB).
<ul style="list-style-type: none"> ■ Control unit incorrectly adjusted. ■ Remote control (if installed) set incorrectly.  See separate operating instructions	Check settings and correct if required: <ul style="list-style-type: none"> - DHW heating must be enabled (refer to page 24). - DHW temperature (refer to page 24). - Time program (refer to page 25). - Time (refer to page 28).
No fuel.	With LPG: Check the fuel reserves and re-order if required. With natural gas: Open the gas shut-off valve. If necessary, check with your gas supply utility.
"Fault" is displayed, and the red fault indicator flashes.	Call up and acknowledge the type of fault (refer to page 32).

The DHW is too Hot

Cause	Remedy
The control unit is incorrectly adjusted.	Check and correct the DHW temperature if required (refer to page 24).
	Check and correct settings, if required, at the solar control unit.  See separate operating instructions

“⚠” Flashes and “Fault” is Displayed

Cause	Remedy
Heating system fault.	Proceed as described (refer to page 32).

“🔧” Flashes and “Service” is Displayed

Cause	Remedy
The time for a service, as specified by your heating contractor, has arrived.	Proceed as described on page 31.

“Controls Locked Out” is Displayed

Cause	Remedy
Control was blocked by your heating contractor.	Your heating contractor can lift this block.

“External Hook-up” is Displayed

Cause	Remedy
The operating program set at the control unit was changed by an external device, e.g. extension EA1.	No remedy is required.

“External Program” is Displayed

Cause	Remedy
The operating program set at the control unit was changed by the Vitocom communication interface	You can change the operating program.

Inspection/Cleaning/Maintenance

Cleaning

All equipment can be cleaned with a commercially available domestic cleaning agent (non-scouring). Clean the surface of the programming unit with the microfibre cloth provided.

Inspection and maintenance

Regular maintenance ensures trouble free, energy efficient, environmentally responsible and safe heating. Your heating system must be serviced by an authorised contractor at least every 2 years. For this, we advise you to arrange an inspection and maintenance contract with your local heating contractor.

Boiler

Increasing boiler contamination raises the flue gas temperature and thereby increases energy losses. For that reason, all boilers should be cleaned annually.

DHW tank

Maintenance and cleaning should be carried out no later than two years after commissioning and thereafter as required.

Only a qualified heating contractor should clean the inside of a DHW tank and the DHW connections. Refill any water treatment equipment (e.g. water softener or water filtration unit) on time, if such equipment is installed in the cold water supply of the DHW tank. Observe the manufacturer's instructions.

Additionally for a Vitocell 100:

We recommend that the correct function of the sacrificial anode is checked annually by your heating contractor. The anode function can be checked without interrupting the system operation. The heating contractor will check the earth current with an anode tester.

Safety valve (DHW tank)

The safety valve function should be checked every six months by venting, either by the system user or the local heating contractor. The valve seat may become contaminated (see the valve manufacturer's instructions).

Potable water filter (if installed)

To maintain high hygienic standards, proceed as follows:

- Replace filter element on non-back flushing filters every six months (visual inspection every two months).
- On back flushing filters, back flush every two months.

Overview of Extended Menu

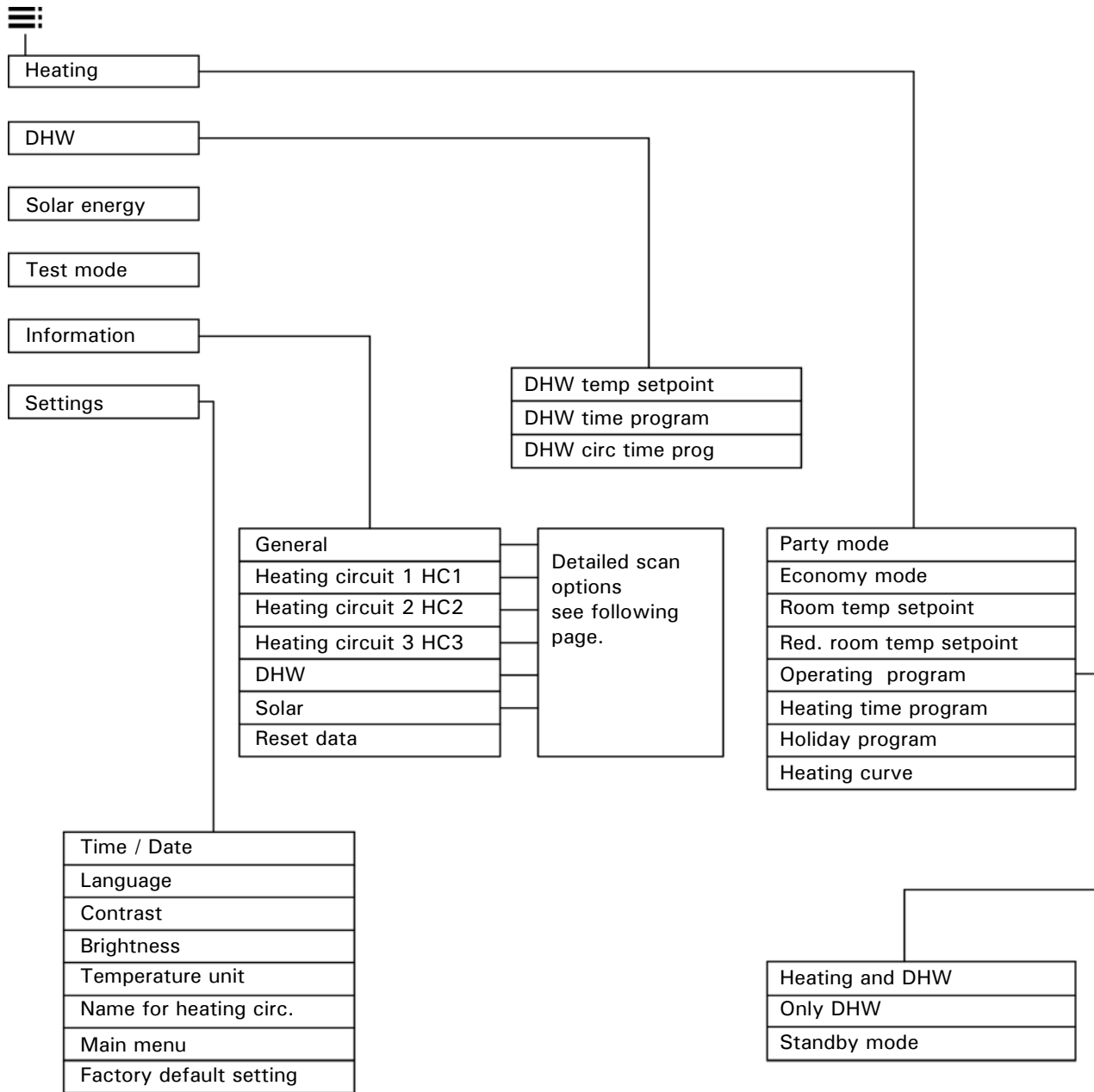

Calling up Options Under "Information"

Scanning options in the extended menu

Note: Subject to the actual heating system equipment level, not all of the scans listed here may be available. You can view more details on the information marked with ▶.

General	
"Outside temp"	
"Boiler temperature"	
"Flue gas temp"	
"Sensor 9"	
"Burner"	
"Operating hours"	
"Burner stage 1"	
"Hours run"	
"Burner stage 2"	
"Hours run"	
"Fuel consumption"	
"Feed pump"	
"Block 3rd pty dev"	
"Compiled fault msg."	
"Participant no."	
"Input ext. EA1"	▶
"Time"	
"Date"	
"Radio clock signal"	

Heating circuit 1 (HC1)	
"Operating program"	▶
■ "External hook-up"	
■ "Holiday program"	
■ "External program"	
■ "Party mode"	
■ "Economy mode"	
■ "Heating and DHW"	
■ "Only DHW"	
■ "Standby mode"	
"Operating status:"	▶
■ "Standard heating mode"	
■ "Reduced mode"	
■ "Standby mode"	
"Time program"	▶
"Room temp setpoint"	
"Room temperature"	
"Red. room temp setpoint"	
"Set ext. room temp"	
"Set party temp"	
"Slope"	
"Shift"	
"Heating circ pump"	
"Holiday program"	▶

Heating circuit 2, 3 (HC2, HC3)	
"Operating program"	▶
■ "External hook-up"	
■ "Holiday program"	
■ "External program"	
■ "Party mode"	
■ "Economy mode"	
■ "Heating and DHW"	
■ "Only DHW"	
■ "Standby mode"	
"Operating status:"	▶
■ "Standard heating mode"	
■ "Reduced mode"	
■ "Standby mode"	
"Time program"	▶
"Set room temperature"	
"Room temperature"	
"Set reduced room temp"	
"Set ext. room temp"	
"Set party temp"	
"Slope"	
"Shift"	
"Heating circ pump"	
"Mixing valves"	
"Supply temperature"	
"Return temp"	
"Holiday program"	▶

DHW	
"DHW time program"	▶
"DHW circ time prog"	▶
"DHW temperature"	
"DHW loading pump"	
"DHW circ pump"	

Solar	
"Collector temp"	
"Solar DHW"	
"Solar circuit pump" (hours run)	
"Solar energy history"	▶
"Solar energy"	
"Solar circuit pump" (ON/OFF) or	
"Solar circ pump speed"	
"Heating suppr. DHW"	
"SM1 output 22" (ON/OFF)	
"SM1 output 22" (hours run)	
"Sensor 7"	
"Sensor 10"	
"Heat suppr. heating"	

Terminology

Operating program

The operating program determines whether you heat your rooms and DHW, or only heat DHW, or whether you switch off central heating (with frost protection monitoring).

Operating status

In the operating program "Heating and DHW", the operating status changes from "Standard heating mode" to "Reduced heating mode" and vice versa. The times for the operating status changeover are defined by you when setting the time program.

Extension kit for heating circuit with mixing valve

Assembly (accessory) for controlling a heating circuit with mixing valves. See "Mixing valves".

Mixing Valve

A mixing valve mixes the water heated in the boiler with the cooled water returning from the heating circuit. The water, heated to the right temperature in line with demand, is delivered to the heating circuit by the heating circuit pump. The control unit adjusts the heating circuit supply temperature via the mixing valve to the various conditions, e.g. different outside temperature.

Under floor heating system

Under floor heating systems are slow, low temperature heating systems and only respond very slowly to short term temperature changes. Therefore, heating to the reduced room temperature at night and enabling "Economy mode" during short absences do not result in significant energy savings.

Heating mode

Standard heating mode

For periods when you will be at home during the day, use the standard room temperature to heat your rooms. Set the periods (time phases) using the time program for central heating.

Reduced heating mode

For periods when you will be absent or during the night, heat your rooms to the reduced room temperature. Set the periods using the time program for central heating. With underfloor heating systems, reduced heating mode only yields limited energy savings (see "Underfloor heating").

Room temperature-dependent heating mode

With room temperature-dependent operation a room will be heated until the selected set room temperature has been reached. A separate temperature sensor must be installed in the room for this purpose. The heating output is regulated independent of the outside temperature.

Weather-compensated heating mode

In weather-compensated operation, the supply temperature is controlled according to the outside temperature.

This means that only that amount of heat is generated that is necessary to heat the rooms to the room temperature you selected.

The outside temperature is captured and transmitted to the control unit by a sensor fitted outside the building.

Terminology (continued)

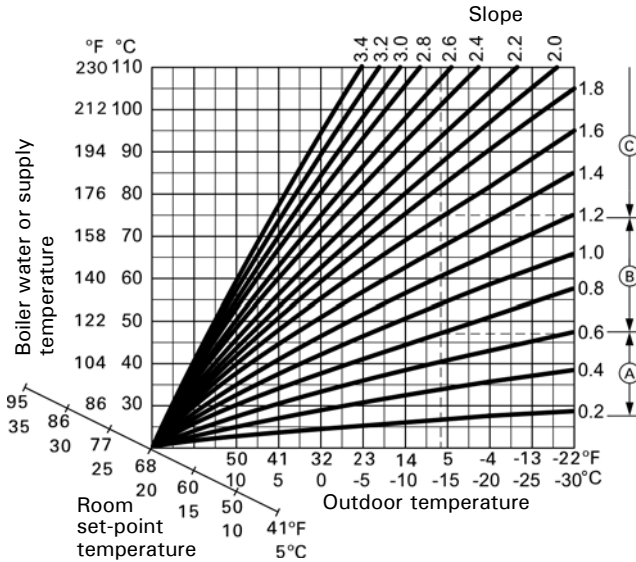

Example:

For outside temperature 7°F (-14°C):

- (A) Underfloor heating system, slope 0.2 to 0.8
- (B) Low temperature heating system, slope 0.8 to 1.6
- (C) Heating system with a boiler water temperature in excess of 167°F (75°C), slope 1.6 to 2.0

Heating curve

Heating curves illustrate the relationship between the outside temperature, room temperature (set value) and boiler water or (heating circuit) supply temperature. The lower the outside temperature, the higher the boiler water temperature or heating circuit supply temperature. In order to guarantee sufficient heat and minimum fuel consumption at any outside temperature, the conditions of your building and your heating system must be taken into consideration. For this, you can adapt the heating curve yourself.

Note: If your heating system includes heating circuits with mixing valves, then the supply temperature for the heating circuit without mixing valve is higher by a selected differential than the supply temperature for the heating circuits with mixing valve.

The illustrated heating curves apply with the following settings:

- Heating curve shift = 0
- Standard room temperature (set value) = 68°F (20°C)

Note: Setting the slope or shift of the heating curve too high or too low will not result in damage to your heating system.

Both settings affect the shift of the supply temperature, which may then be too low or unnecessarily high.

Tips on when and how to change the heating curve slope and shift are displayed by pressing ?.

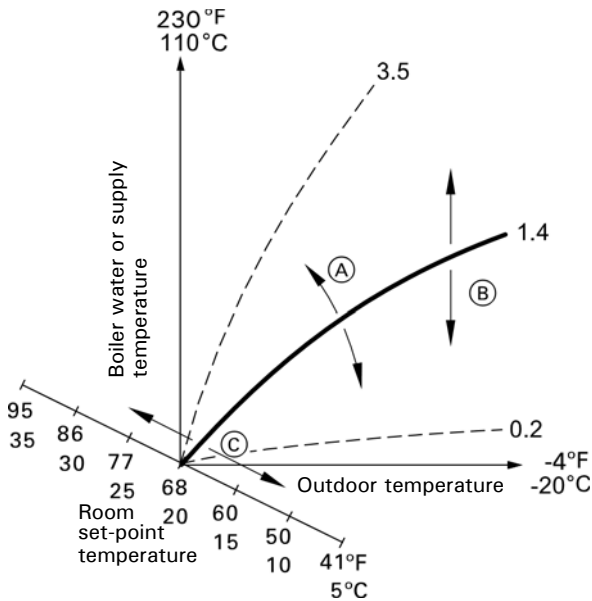

Legend

- (A) Changing the slope:
The gradient of the heating curves changes.
- (B) Changing the shift:
The heating curves are shifted in parallel in a vertical direction.
- (C) Changing the standard room temperature (set value):
The heating curves are offset along the "Set room temperature" axis.

Terminology *(continued)***Heating circuit**

A heating circuit is a sealed circuit between the boiler and radiators, in which the heating water circulates. A heating system may comprise several heating circuits. For example, one heating circuit for the rooms occupied by you and one heating circuit for the rooms of a separate apartment.

Heating circuit pump

Circulation pump for the circulation of the heating water in the heating circuit.

Room temperature**■ Standard room temperature:**

For periods when you will be at home during the day, set the standard room temperature.

■ Reduced room temperature:

For periods when you will be absent or during the night, set the reduced room temperature. See also "Heating mode".

Safety valve

A safety device that must be installed in the cold water pipe by your heating contractor. The safety valve opens automatically to prevent excess pressure in the DHW Tank.

Solar circuit pump

In conjunction with solar thermal systems. The solar circuit pump transports the heated heat transfer medium from the collectors into the indirect coil of the DHW tank

Set temperature

Default temperature that should be reached; e.g. set DHW temperature.

DHW pump

Circulation pump for heating the DHW in the DHW tank.

Drinking water filter

A device that removes solids from the drinking water. The drinking water filter is installed in the cold water pipe upstream of the DHW tank or the instantaneous water heater.

Weather-compensated heating mode

See "Heating mode".

DHW recirculation pump

The DHW recirculation pump transports the DHW around a ring pipeline between the DHW tank and the draw-off points (e.g. hot tap). This ensures that hot water is rapidly available at the draw-off point.





Printed on environmentally friendly
(recycled and recyclable) paper.

Technical information subject to change without notice.

Viessmann Manufacturing Company Inc.
750 McMurray Road
Waterloo, Ontario • N2V 2G5 • Canada
TechInfo Line 1-888-484-8643
1-800-387-7373 • Fax (519) 885-0887
www.viessmann.ca • info@viessmann.ca

Viessmann Manufacturing Company (U.S.) Inc.
45 Access Road
Warwick, Rhode Island • 02886 • USA
TechInfo Line 1-888-484-8643
1-800-288-0667 • Fax (401) 732-0590
www.viessmann-us.com • info@viessmann-us.com