

DeltaTherm[®] HC mini

beginning with firmware version 2.0

RESOL[®]

Heating controller

Manual for the
specialised craftsman

Installation

Operation

Functions and options

Troubleshooting

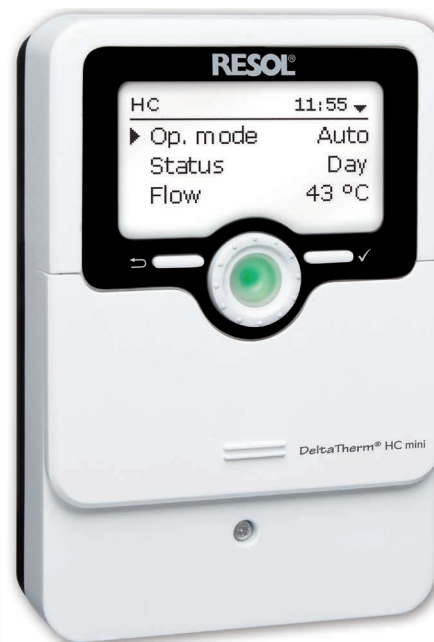

10000953



The Internet portal for easy and secure access to
your system data – www.vbus.net

Thank you for buying this product.

Please read this manual carefully to get the best performance from this unit. Please keep this manual safe.

en

Manual

www.resol.com

Safety advice

Please pay attention to the following safety advice in order to avoid danger and damage to people and property.

Danger of electric shock:

- When carrying out works, the device must first of all be disconnected from the mains.
- It must be possible to disconnect the device from the mains at any time.
- Do not use the device if it is visibly damaged!

The device must not be used by children or persons with reduced physical, sensory or mental abilities or without any experience and knowledge. Make sure that children do not play with the device!

Only connect accessories authorised by the manufacturer to the device.

Make sure that the housing is properly closed before commissioning the device.

Set the code to the customer code before handing over the controller to the customer.

Target group

These instructions are exclusively addressed to authorised skilled personnel.

Only qualified electricians are allowed to carry out electrical works.

Initial commissioning must be effected by authorised skilled personnel.

Authorised skilled personnel are persons who have theoretical knowledge and experience with the installation, commissioning, operation, maintenance, etc. of electric/electronic devices and hydraulic systems and who have knowledge of relevant standards and directives.

Instructions

Attention must be paid to the valid local standards, regulations and directives!

Subject to technical change. Errors excepted.

Information about the product

Proper usage

The controller is designed for use in heating systems in compliance with the technical data specified in this manual.

Any use beyond this is considered improper.

Proper usage also includes compliance with the specifications given in this manual. Improper use excludes all liability claims.



Note

Strong electromagnetic fields can impair the function of the device.

- ➔ Make sure the device as well as the system are not exposed to strong electromagnetic fields.

EU Declaration of conformity

The product complies with the relevant directives and is therefore labelled with the CE mark. The Declaration of Conformity is available upon request, please contact the manufacturer.



Scope of delivery

The scope of delivery of this product is indicated on the packaging label.

Storage and transport

Store the product at an ambient temperature of 0 ... 40 °C and in dry interior rooms only.

Transport the product in its original packaging only.

Cleaning

Clean the product with a dry cloth. Do not use aggressive cleaning fluids.

Data security

We recommend regular backups of the data stored on the device via MicroSD card.

Decommissioning

1. Disconnect the device from the power supply.
2. Dismount the device.

Disposal

- Dispose of the packaging in an environmentally sound manner.
- At the end of its working life, the product must not be disposed of as urban waste. Old appliances must be disposed of by an authorised body in an environmentally sound manner. Upon request we will take back your old appliances bought from us and guarantee an environmentally sound disposal of the devices.



Description of symbols

Warnings are indicated with a warning symbol!

Signal words describe the danger that may occur, when it is not avoided.

WARNING



means that **injury, possibly life-threatening injury, can occur.**

→ It is indicated how to avoid the danger described.

ATTENTION



means that **damage to the appliance can occur.**

→ It is indicated how to avoid the danger described.



Note

Notes are indicated with an information symbol.

→ Texts marked with an arrow indicate one single instruction step to be carried out.

1. Texts marked with numbers indicate several successive instruction steps to be carried out.

The heating controller offers a compact and user-friendly solution for simple heating systems. It controls a weather-compensated heating circuit and its backup heating demand. Additional DHW functions such as circulation or thermal disinfection, and the implementation of further heating circuits via extension modules are possible. Additionally, there's a choice of 6 different operating modes, a boiler protection option and a night correction.

Due to the commissioning menu and the 4 pre-configured basic systems, configuration is quick and easy.

In summer, the heating circuit takes over the demand-based cooling by means of a humidity sensor for dew point calculation.

Contents

1 Overview	5	8 Heating	31
2 Installation	6	8.1 Shared relays.....	31
2.1 Mounting	6	8.2 Heating circuits.....	33
2.2 Electrical connection.....	8	8.3 Optional functions	42
2.3 Data communication / Bus.....	10	8.4 Screed drying.....	46
2.4 MicroSD card slot.....	10	9 Arrangement	47
3 Operation and function	11	9.1 Optional functions	47
3.1 Buttons and adjustment dial	11	10 HQM	54
3.2 Microbutton for chimney sweeper function and holiday mode.....	11	11 Basic settings	56
3.3 Operating control LED	11	11.1 Sensors	56
3.4 Selecting menu points and adjusting values.....	11	11.2 Modules	57
3.5 Adjusting the timer	13	11.3 Devices	57
3.6 Adjusting functions.....	15	12 SD card	58
3.7 Output submenu	17	13 Manual mode	59
3.8 Sensor configuration.....	19	14 User code	59
4 Commissioning	20	15 Troubleshooting	60
4.1 Schemes with basic settings	22	16 Index	62
4.2 Step-by-step parameterisation	27		
5 Menu structure	28		
6 Main menu	29		
7 Status	29		
7.1 Heating.....	29		
7.2 Arrangement	30		
7.3 HQM	30		
7.4 Measured / Balance values.....	30		
7.5 Messages.....	30		
7.6 Home screen.....	30		

1 Overview

- 4 pre-configured basic systems
- Cooling over the heating circuit with humidity sensor
- Up to 5 extension modules via VBus® connectable, up to 7 weather-compensated heating circuits
- 6 operating modes, boiler protection, room thermostat and night correction
- Holiday mode and chimney sweeper function via microbuttons
- Data logging, storing, easy transfer of controller adjustments prepared and firmware updates via MicroSD card
- Modulating heating control with 0-10 V boiler control
- Weather-compensated control with room influence or demand-based room control with up to 5 room temperature sensors
- Remote access with a room control unit or the VBus® Touch HC App
- Heat pump demand (optional)

Technical data

Inputs: 5 inputs for Pt1000, Pt500 or KTY temperature sensors (can optionally be used for remote controls, operating mode switches or potential-free switches, 1 of them convertible to V40), 1 analogue input for Grundfos Direct Sensor™ or FRH humidity sensor

Outputs: 3 semiconductor relays, 1 potential-free extra-low voltage relay, 2 PWM outputs (switchable to 0-10 V)

PWM frequency: 512 Hz

PWM voltage: 10.8 V

Switching capacity:

1 (1) A 240 V~ (semiconductor relay)

1 (1) A 30 V== (potential-free relay)

Total switching capacity: 3 A 240 V~

Power supply: 100–240 V~ (50–60 Hz)

Supply connection: type X attachment

Standby: 0.62 W

Temperature controls class: VIII

Energy efficiency contribution: 5%

Mode of operation: type 1.B.C.Y action

Rated impulse voltage: 2.5 kV

Data interface: VBus®, MicroSD card slot

VBus® current supply: 60 mA

Functions: weather-compensated heating circuit control, backup heating, room thermostat, chimney sweeper function, screen drying function

Housing: plastic, PC-ABS and PMMA

Mounting: wall mounting, also suitable for mounting into patch panels

Indication / Display: graphic display, operating control LED (Lightwheel®)

Operation: 4 buttons and 1 adjustment dial (Lightwheel®)

Ingress protection: IP 20/EN 60529

Protection class: I

Ambient temperature: 0... 40 °C

Degree of pollution: 2

Relative humidity: 10... 90 %

Fuse: T4A

Maximum altitude: 2000 m above MSL

Dimensions: 110 x 166 x 47 mm

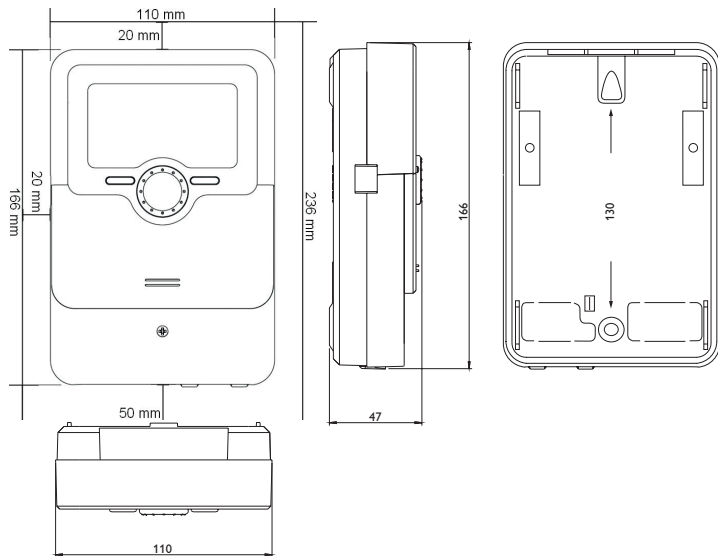

2 Installation

2.1 Mounting

WARNING! Danger of electric shock!



Upon opening the housing, live parts are exposed!

→ **Always disconnect the device from power supply before opening the housing!**



Note

Strong electromagnetic fields can impair the function of the device.

→ Make sure the device as well as the system are not exposed to strong electromagnetic fields.

The device must only be located in dry interior rooms.

If the device is not equipped with a mains connection cable and a plug, the device must additionally be supplied from a double pole switch with contact gap of at least 3 mm or must be equipped with a disconnecting device (fuse) in accordance with the required installation regulations.

Please pay attention to separate routing of sensor cables and mains cables.

In order to mount the device to the wall, carry out the following steps:

1. Unscrew the crosshead screw from the cover and remove it along with the cover from the housing.
2. Mark the upper fastening point on the wall. Drill and fasten the enclosed wall plug and screw leaving the head protruding.
3. Hang the housing from the upper fastening point and mark the lower fastening points (centres 130 mm).
4. Insert lower wall plug.
5. Fasten the housing to the wall with the lower fastening screws and tighten.
6. Carry out the electrical wiring in accordance with the terminal allocation (see page 8).
7. Put the cover on the housing.
8. Attach with the crosshead screw.

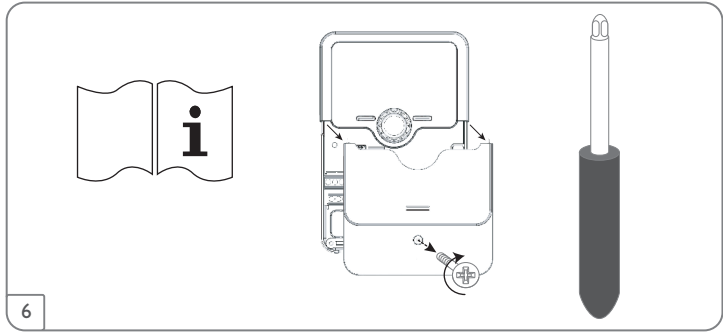
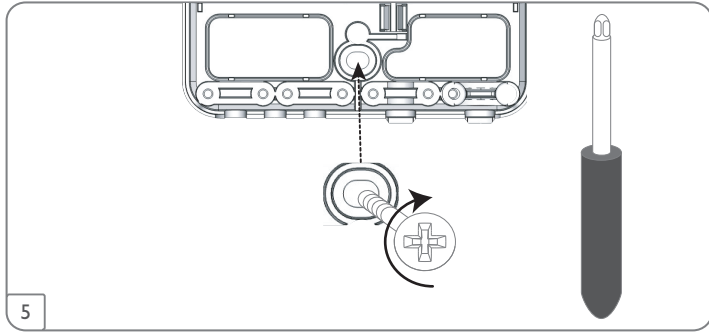
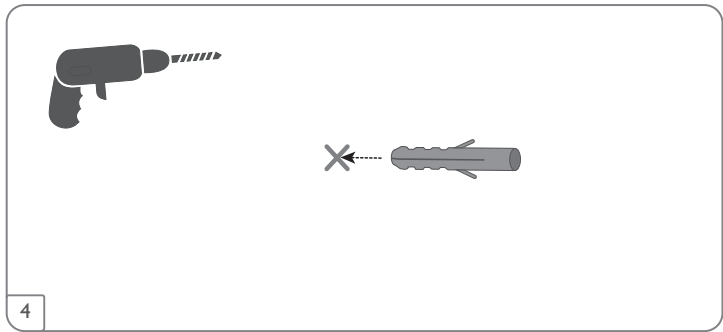
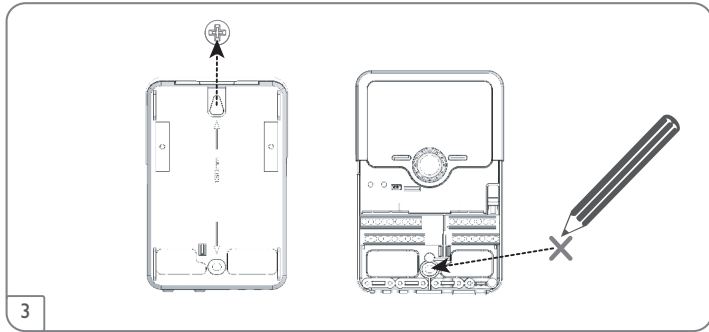
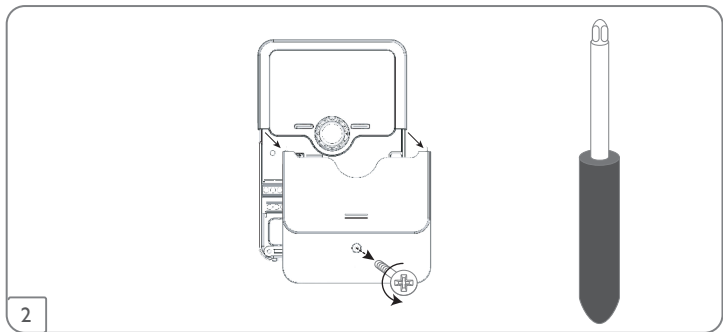
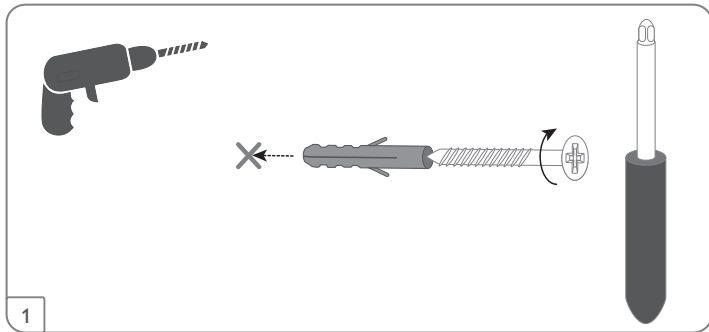

2.2 Electrical connection

WARNING! Danger of electric shock!



Upon opening the housing, live parts are exposed!

→ **Always disconnect the device from power supply before opening the housing!**

ATTENTION! Damage by overheating! Danger of fire!



Improper connection of cables to the terminals can lead to damage caused by overheating!

→ **For a safe and permanent electrical connection, take care to properly connect the cables to the terminals according to IEC 60947-1!**

ATTENTION! ESD damage!



Electrostatic discharge can lead to damage to electronic components!

→ **Take care to discharge properly before touching the inside of the device! To do so, touch a grounded surface such as a radiator or tap!**



Note

Connecting the device to the power supply must always be the last step of the installation!



Note

The **Speed** option must be set to **Off** when non-speed-controlled devices such as valves are connected.



Note

It must be possible to disconnect the device from the mains at any time.

- Install the mains plug so that it is accessible at any time.
- If this is not possible, install a switch that can be accessed.

If the mains cable is damaged, it must be replaced by a special connection cable which is available from the manufacturer or its customer service.

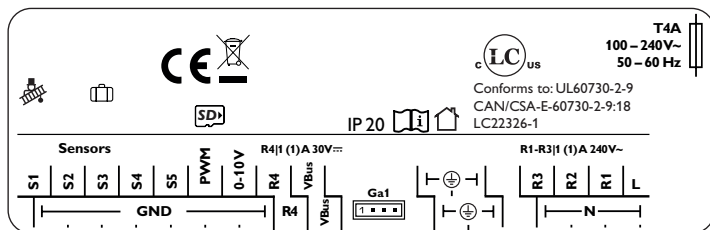

Do not use the device if it is visibly damaged!

The controller is equipped with **4 relays** in total to which loads such as pumps, valves, etc. can be connected:

Relays 1 ... 3 are semiconductor relays, designed for pump speed control:

Conductor R1 ... R3

Neutral conductor N (common terminal block)

Protective earth conductor \ominus (common terminal block)

Relay 4 is a potential-free extra-low voltage relay:

Connections to the R4 terminals can be made with either polarity.

Depending on the product version, mains cables and sensor cables are already connected to the device. If that is not the case, please proceed as follows:

Attach flexible cables to the housing with the enclosed strain relief and the corresponding screws.

Connect the **temperature sensors** (S1 to S5) to the terminals S1... S5 and GND (either polarity).

The cables carry low voltage and must not run together in a cable conduit with cables carrying a voltage higher than 50 V (please pay attention to the valid local regulations). The cable lengths depend on the cross-sectional area.

Example: up to 100 m at 1.5 mm², up to 50 m at 0.75 mm². The cables can be extended with a two-wire cable.

A **V40** flowmeter can be connected to the terminals S5 / V40 and GND (either polarity).

The terminals marked **PWM/0-10V** are control outputs for high-efficiency pumps (for connection see illustration).

Electrical connection of a high-efficiency pump (HE pump)

Speed control of a HE pump is possible via a PWM signal / 0-10V control. The pump has to be connected to the relay (power supply) as well as to one of the PWM outputs of the controller. In the **Output** adjustment channel one of the PWM control types as well as a relay have to be selected (see page 17).

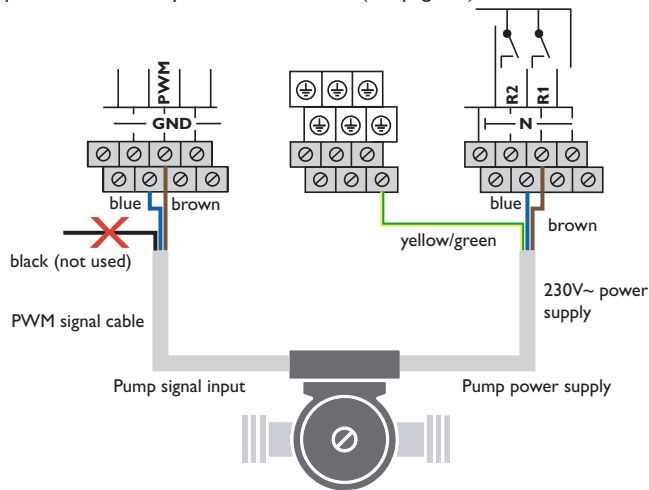

Note

When Grundfos Direct Sensors™ are used, connect the sensor ground common terminal block to PE.

Connect the **analogue Grundfos Direct Sensor™** or **FRH humidity sensor** to the Ga1 input.

The controller is supplied with power via a mains cable. The power supply of the device must be 100–240V~ (50–60 Hz).

Connect the **mains cable** to the following terminals:

Neutral conductor N

Conductor L

Protective earth conductor ⊕ (common terminal block)



Note

For more details about the commissioning procedure see page 20.

2.3 Data communication / Bus

The controller is equipped with a VBus® for data transfer and energy supply to external modules. The connection is to be carried out at the terminals marked **VBus** (any polarity).

One or more VBus® modules can be connected via this data bus.

Different solutions for visualisation and remote parameterisation are available on the website www.resol.com. On the website, firmware updates are also available.

2.4 MicroSD card slot

The controller is equipped with a MicroSD card slot.

With a MicroSD card, the following functions can be carried out:

- Store measurement and balance values onto the MicroSD card. After the transfer to a computer, the values can be opened and visualised, e.g. in a spreadsheet.
- Prepare adjustments and parameterisations on a computer and transfer them via the MicroSD card.
- Store adjustments and parameterisations on the MicroSD card and, if necessary, retrieve them from there.
- Download firmware updates from the Internet and install them on the controller via MicroSD card.

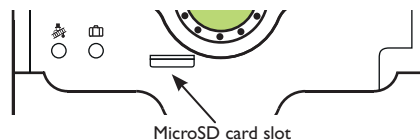

Note

For more information about using a MicroSD card, see page 58.

3 Operation and function

3.1 Buttons and adjustment dial

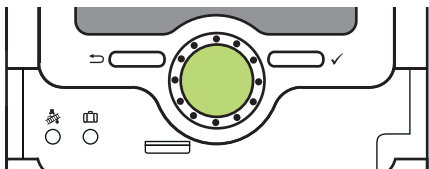

The controller is operated via 2 buttons and 1 adjustment dial (Lightwheel®) below the display:



Left button (←) - escape button for changing into the previous menu / to the home screen (keep pressed for 2 s, see page 30)



Right button (✓) - confirming / selecting

Lightwheel® - scrolling upwards/scrolling downwards, increasing adjustment values / reducing adjustment values

3.2 Microbutton for chimney sweeper function and holiday mode





The controller is equipped with two microbuttons for quick access to the holiday mode and the chimney sweeper function. The microbuttons are located underneath the slidable housing cover, the slider.

Microbutton : The **chimney sweeper function** can be triggered with the microbutton . The chimney sweeper function is activated by default. In order to trigger the chimney sweeper function, press and hold down the microbutton  for 3 s.

Microbutton : The microbutton  is used for activating the holiday mode. If the microbutton is pressed and held down for approx. 3 s, the adjustment channel **Days of absence** appears, allowing to enter the number of days for an absence. If the parameter is set to a value higher than 0, the holiday mode becomes active and the days will be counted backwards at 00:00. If the value is set to 0, the holiday mode is deactivated.

3.3 Operating control LED

The controller is equipped with a multicolour LED in the centre of the Lightwheel®, indicating the following states:

Colour	Permanently shown	Flashing
	Everything OK	Manual mode on, initialisation
	Screed drying cancelled	Sensor line break, sensor short circuit
	Holiday mode active	Chimney sweeper function / screed drying active
		Manual mode off

3.4 Selecting menu points and adjusting values

During normal operation of the controller, the display shows the status menu.

If no button is pressed for 1 min, the display illumination switches off. After 3 further minutes, the controller will display the home screen (see page 30).

→ In order to get from the status menu into the main menu, press the left button (←)!

→ Press any key to reactivate the display illumination.

→ In order to scroll through the menu items, turn the Lightwheel®.

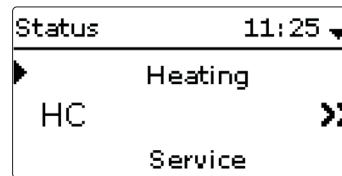

If the symbol  is shown behind a menu item, pressing the right button (✓) will open a new submenu.

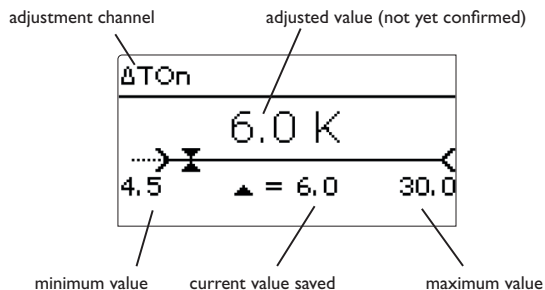

Values and options can be changed in different ways:

Numeric values can be adjusted by means of a slide bar. The minimum value is indicated to the left, the maximum value to the right. The large number above the slide bar indicates the current adjustment. By turning the Lightwheel®, the upper slide bar can be moved to the left or to the right.

Only after the adjustment has been confirmed by pressing the right button (✓) will the number below the slide bar indicate the new value. The new value will be saved if it is confirmed by pressing the right button (✓) again.

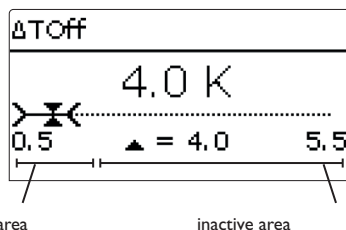

When values are locked against each other, they will display a reduced adjustment range depending on the adjustment of the respective other value.

In this case, the active area of the slide bar is shortened, the inactive area is indicated as a dotted line. The indication of the minimum and maximum values will adapt to the reduction.

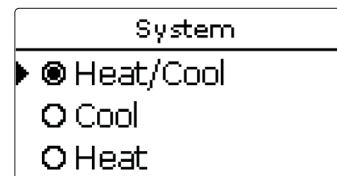

If only one item of several can be selected, they will be indicated with radio buttons. When one item has been selected, the radio button in front of it is filled.

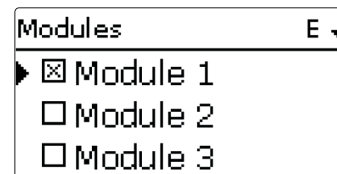

If more than one item of several can be selected, they will be indicated with checkboxes. When an item has been selected, an x appears inside the checkbox.

If no button has been pressed within a couple of minutes, the adjustment is cancelled and the previous value is retained.

3.5 Adjusting the timer

When the **Timer** option is activated, a timer is indicated in which time frames for the function can be adjusted.

In the **Day selection** channel, the days of the week are available individually and as frequently selected combinations.

If more than one day or combination is selected, they will be merged into one combination for the following steps.

The last menu item after the list of days is **Continue**. If Continue is selected, the timer menu opens, in which the time frames can be adjusted.

▶ Day selection
Reset
back

Day selection

Mon-Sun
 Mon-Fri
 Sat-Sun
 Mon
 Tue
 Wed
 Thu
 Fri
 Sat
 Sun

▶ Continue

Adding a time frame:

In order to add a time frame, proceed as follows:

1. Select **New time frame**.

Mon, Wed, Sun

00 06 12 18

▶ New time frame
Copy from

Mon, Wed, Sun

▶ Start ---:--
Stop ---:--
back

2. Adjust **Start** and **Stop** for the desired time frame. The time frames can be adjusted in steps of 15 min.

Start

06:00

3. In order to save the time frame, select **Save** and confirm the security enquiry with **Yes**.

Stop

08:30

Mon, Wed, Sun

Start 06:00
Stop 08:30

▶ Save

Save

Save? Yes

4. In order to add another time frame, repeat the previous steps.

6 time frames can be adjusted per day or combination.

Mon, Wed, Sun

00 06 12 18

▶ New time frame
Copy from

Mon, Wed, Sun

00 06 12 18

▶ New time frame
Copy from

5. Press the left button in order to get back to the day selection.

Day selection

▶ Mon, Wed, Sun
Reset

Copying a time frame:

In order to copy time frames already adjusted into another day / another combination, proceed as follows:

1. Choose the day / the combination into which the time frames are to be copied and select **Copy from**.

A selection of days and / or combinations with time frames will appear.

2. Select the day or combination from which the time frames are to be copied.

All time frames adjusted for the selected day or combination will be copied.

If the time frames copied are not changed, the day or combination will be added to the combination from which the time frames have been copied.

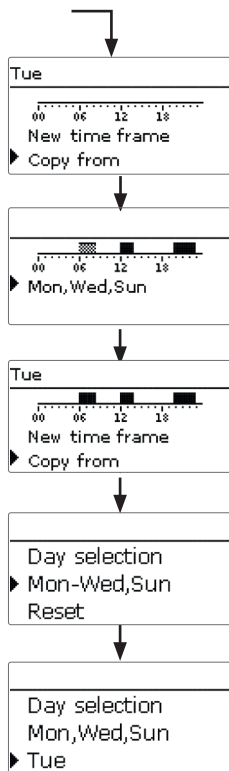

Changing a time frame:

In order to change a time frame, proceed as follows:

1. Select the time frame to be changed.
2. Make the desired change.
3. In order to save the time frame, select **Save** and confirm the security enquiry with **Yes**.

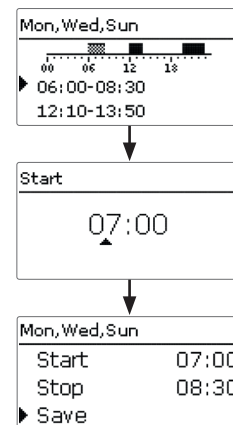

Removing a time frame:

In order to delete a time frame, proceed as follows:

1. Select the time frame that is to be deleted.
2. Select **Delete** and confirm the security enquiry with **Yes**.

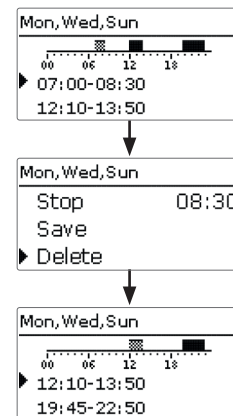

Resetting the timer:

In order to reset time frames adjusted for a certain day or combination, proceed as follows:

1. Select the desired day or combination.

Day selection
▶ Mon,Wed,Sun
Tue

Mon,Wed,Sun
00 06 12 18
Copy from
▶ Reset

Reset
Reset? Yes

▶ Day selection
Tue
Reset

2. Select **Reset** and confirm the security enquiry with **Yes**.

The selected day or combination will disappear from the list, all its time frames will be deleted.

In order to reset the whole timer, proceed as follows:

- ➔ Select **Reset** and confirm the security enquiry with **Yes**.

Mon,Wed,Sun
Tue
▶ Reset

Reset
Reset? Yes

All adjustments made for the timer are deleted.

Day selection
▶ Reset
back

3.6 Adjusting functions

Add new function	E
▶ Th. Disinfection	
DHW heating	
DHW preheat.	

In the **Optional functions / Add new function** menus, optional functions can be selected and adjusted.

The kind and number of optional functions offered depends on the previous adjustments.



Note

For most optional functions, an extension module is required.

Th. Disinfection	E
▶ Dem and	A
<input type="checkbox"/> Circulating pump	
Sensor	

When a function is selected, a submenu opens in which all adjustments required can be made.

In this submenu, an output and, if necessary, certain system components can be allocated to the function.

If an output can be allocated to the function, the **Output** submenu opens (see page 17).

When a function has been adjusted and saved, it will appear in the **Opt. functions** menu above the menu item **Add new function**.

Heating/Opt. funct.	E
▶ Th. Disinfection	
DHW heating	
Add new function	

This allows an easy overview of functions already saved.

An overview about which sensor has been allocated to which component and which output has been allocated to which function is given in the **Status** menu.

Circulation	E ▲
Toff	45 °C
Funct.	Activated
▶ Save function	

At the end of each optional function submenu, the menu items **Funct.** and **Save function** are available. In order to save a function, select **Save function** and confirm the security enquiry by selecting **Yes**.

In functions already saved, the menu item **Delete function** will appear instead.

Circulation	E ▲
Toff	45 °C
Funct.	Activated
▶ Delete function	

In order to delete a function already saved, select **Delete function** and confirm the security enquiry by selecting **Yes**. The function will become available under **Add new function** again. The corresponding outputs will be available again.

Funct.
<input type="radio"/> Switch
▶ <input checked="" type="radio"/> Activated
<input type="radio"/> Deactivated

With the menu item **Funct.**, an optional function already saved can be temporarily deactivated or re-activated respectively. In this case, all adjustments will remain stored, the allocated outputs will remain occupied and cannot be allocated to another function. The allocated sensor will be monitored for faults.

By selecting **Switch**, the function can be activated or deactivated respectively by means of an external potential-free switch.

If **Switch** is selected, the channel **Sensor** appears, in which a sensor input can be defined as a switch.

Circulation	E ▲
Toff	45 °C
Funct.	Switch
▶ Sensor	-

3.7 Output submenu

The **Output** submenu is available in almost all functions. Therefore, it will not be explained in the individual function descriptions.

In this submenu, relays and/or signal outputs can be allocated to the function selected. All adjustments required for the outputs can be made in this menu.

All controller and module (if connected) outputs available will be displayed. If - is selected, the function will run normally in the software but will not operate an output. Relay and signal outputs can be activated separately. Depending on the adjustments made, the following results are possible:

Adjustments

Relay option	PWM/0-10V option	Speed control	Result	Behaviour of the relay output	Behaviour of the signal output
Yes	Yes	Yes	→	On/Off	Modulating
Yes	No	Yes	→	Burst control	-
Yes	No	Yes	→	On/Off	-
Yes	No	No	→	On/Off	-
Yes	Yes	Yes	→	On/Off	Modulating
Yes	Yes	Yes	→	On/Off	Modulating
Yes	Yes	No	→	On/Off	0%/100%
No	Yes	Yes	→	-	Modulating
No	Yes	No	→	-	0%/100%

Adjustment channel	Description	Adjustment range / selection	Factory setting
Relay	Relay option	Yes, No	No
Relay	Relay selection	system dependent	system dependent
PWM/0-10V	PWM/0-10V option	Yes, No	No
Output	Signal output selection	system dependent	system dependent
Signal	Signal type	PWM, 0-10V	PWM
Profile	Curve	Solar, Heating	Solar
Speed	Speed control	Yes, No	system dependent
Min.	Minimum speed	20 ... 100%	30%
Max.	Maximum speed	20 ... 100%	100%
Inverted	Inverted switching option	Yes, No	No
Blocking protect.	Blocking protection option	Yes, No	No
Manual mode	Operating mode	On, Max., Auto, Min., Off	Auto

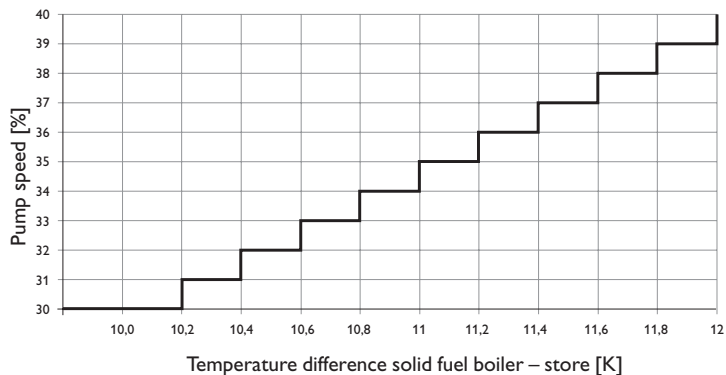
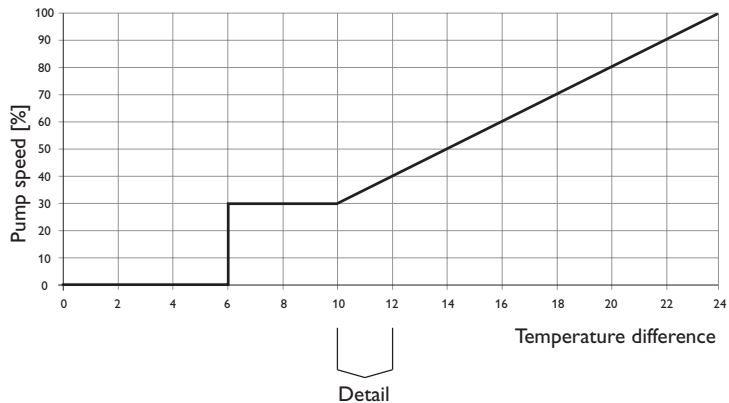

Speed control

In the **Speed** adjustment channel, the speed control for the output can be activated or deactivated respectively. If **Yes** is selected, the channels **Min.** and **Max.** will appear.

In the **Min.** adjustment channel, a relative minimum speed for a pump connected can be allocated to the output

In the **Max.** adjustment channel, a relative maximum speed for a pump connected can be allocated to the output.

For functions controlling loads which are not speed controlled, the speed control will not be shown on the display (e.g. mixer).

If the temperature difference reaches or exceeds the switch-on temperature difference, the pump switches on at 100% speed for 10 s. Then, the speed is reduced to the minimum pump speed value. If the temperature difference exceeds the adjusted set value by 1/10 of the rise value, the pump speed increases by one step (1 %). The response of the controller can be adapted via the parameter **Rise**. Each time the difference increases by 1/10 of the adjustable rise value, the pump speed increases by one step until the maximum pump speed of 100% is reached. If the temperature difference decreases by 1/10 of the adjustable rise value, pump speed will be decreased by one step.

Relay option

If the **Relay** option is activated, a relay can be allocated to the output selection.

PWM/0-10 V option

If the **PWM/0-10 V** option is activated, a PWM/0-10 V output can be allocated to the output selection.

In the **Signal** channel, a selection between a PWM or a 0-10V signal can be made. In the **Profile** channel, characteristic curves for solar and heating pumps can be selected.

Signal characteristic: PWM; Profile: Solar

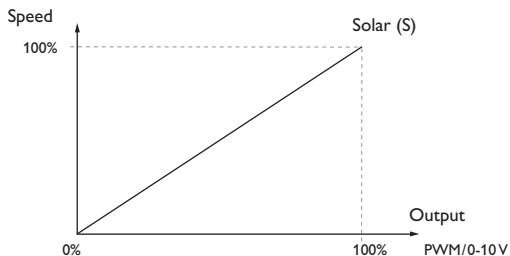

Signal characteristic: PWM; Profile: Heating

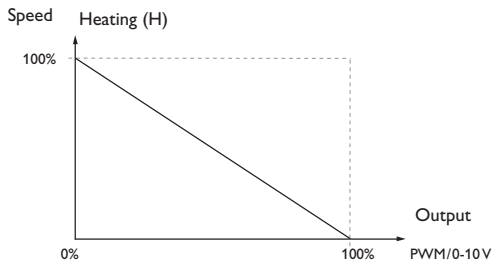

Blocking protection

In order to protect the pumps against blocking after standstill, the controller is equipped with a blocking protection option. This option can be activated in the output selection submenu. The **Blocking protection** option can be adjusted in the **Basic settings/Blocking protect.** menu (see page 56).

Manual mode

In the **Manual mode** adjustment channel, the operating mode of the output can be selected. The following options are available:

On = Output is active at 100% speed (manual mode)

Max. = Output is active at adjusted maximum speed (manual mode)

Auto = Output is in automatic mode

Min. = Output is active at adjusted minimum speed (manual mode)

Off = Output is switched off (manual mode)



Note

After service and maintenance work, the operating mode must be set back to Auto. In manual mode the control logic is suspended.

3.8 Sensor configuration

Some sensors must be registered and configured in the **Basic settings/Sensors** menu (see page 56 and page 59).

In some functions, the **Sensor config.** channel is available for sensor selection, in which sensors not used and not registered can be selected. The selected sensor input will automatically be set to the sensor type required for the function. Registering the sensor in the **Basic settings/Sensors** menu is then no longer necessary.



Note

If a sensor is used as the temperature sensor of a function, the sensor types **Switch**, **Fern**, **BAS** and **None** will not be available for the corresponding input.

4 Commissioning

When the hydraulic system is filled and ready for operation, connect the controller to the mains.

The controller runs an initialisation phase in which the operating control LED flashes green.

When the controller is commissioned or when it is reset, it will run a commissioning menu after the initialisation phase. The commissioning menu leads the user through the most important adjustment channels needed for operating the system.

Disconnecting the controller from the mains after having run the commissioning menu will not delete adjustments that have already been carried out. After you switch on the device again, the controller will not start the commissioning menu, but normal operation after the initialisation phase.

Commissioning menu

The commissioning menu consists of the channels described in the following.

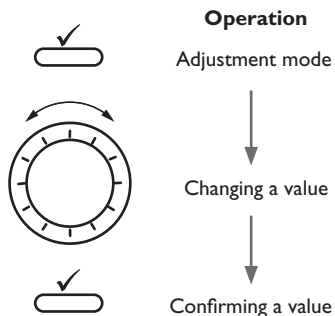

1. Language:

→ Adjust the desired menu language.

2. Units:

→ Adjust the desired unit system.

3. Daylight savings time adjustment:

→ Activate or deactivate the automatic daylight savings time adjustment.

4. Time:

→ Adjust the clock time. First of all adjust the hours, then the minutes.

5. Date:

→ Adjust the date. First of all adjust the year, then the month and then the day.

6. Scheme:

→ Enter the scheme number of the desired system (see page 22).

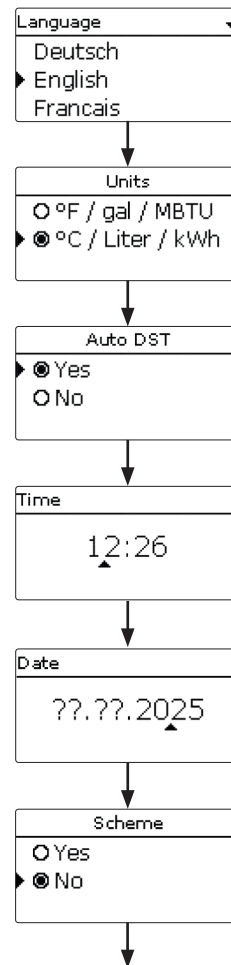

7. Completing the commissioning menu:

After the system has been selected or the scheme number has been entered, a security enquiry appears. If the security enquiry is confirmed, the adjustments will be saved.

- In order to confirm the security enquiry, select **Yes**.
- In order to reenter the commissioning menu channels, select **No**.

If the security enquiry has been confirmed, the controller will be ready for operation.



Note

The adjustments carried out during commissioning can be changed anytime in the corresponding adjustment channel. Additional functions and options can also be activated and adjusted (see page 28).

Set the code to the customer code before handing over the controller to the customer (see page 59).

Save?

Yes

No

4.1 Schemes with basic settings

The controller is pre-programmed for 4 basic systems. The basic pre-adjustments have already been made. For backup heating it is necessary to allocate the demand and the boiler loading pump by means of shared relays. Afterwards the system can easily be extended.

Relay and sensor allocation correspond to the figures.

Scheme 0 has no pre-adjustments. The schemes are set with preceding zeros.

Example: In order to select scheme 3, enter scheme number 0003.

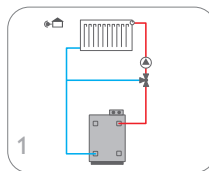
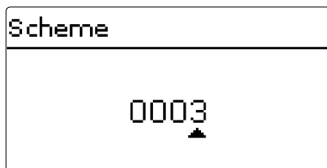

1 mixed heating circuit

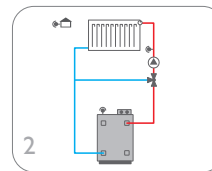

1 mixed heating circuit with backup heating

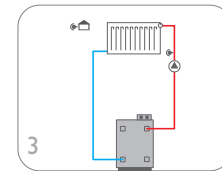

1 unmixed heating circuit

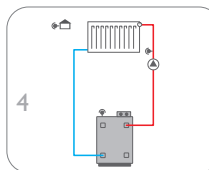

1 unmixed heating circuit with backup heating

Scheme 1: 1 mixed heating circuit

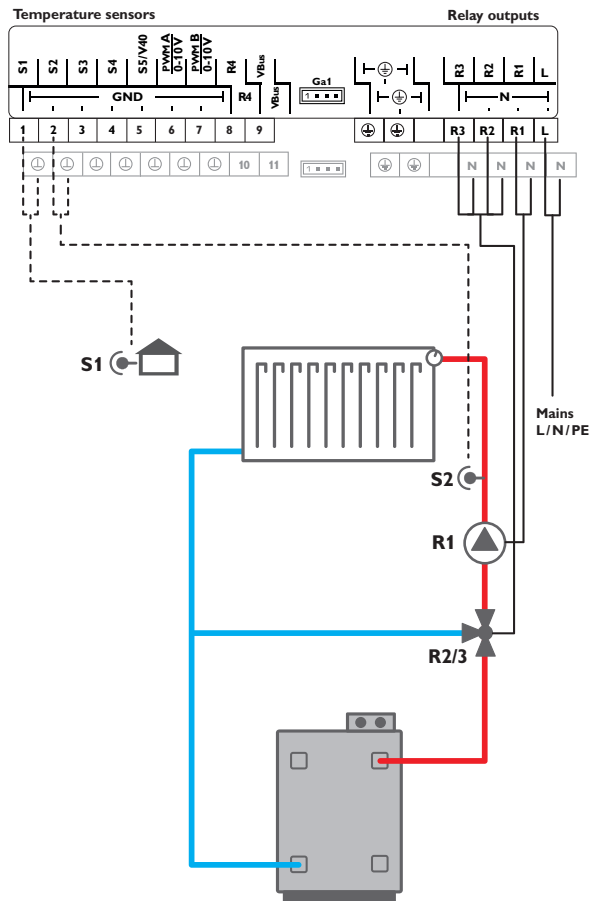

Sensors		
S1	Outdoor	1/GND
S2	Flow HC	2/GND
S3	Free	3/GND
S4	Free	4/GND
S5	Free	5/GND
Relay		
R1	HC pump	R1/N/PE
R2	Mixer open	R2/N/PE
R3	Mixer closed	R3/N/PE
R4	Free	8/10
0-10V/PWM		
A	Free	6/GND
B	Free	7/GND

By means of the outdoor temperature sensor S1 and the flow sensor S2, a mixed weather-compensated heating circuit can be controlled.

Scheme 2: 1 mixed heating circuit with backup heating (demand)

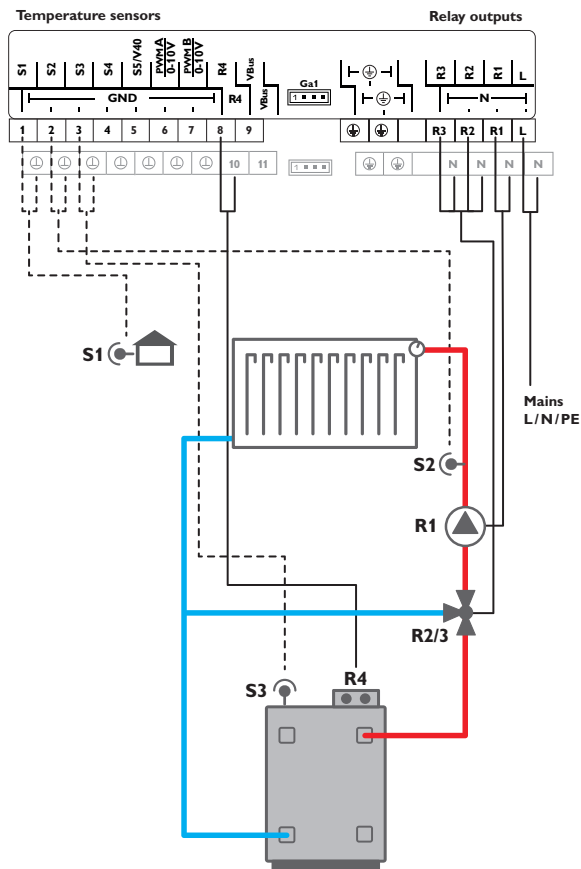

By means of the outdoor temperature sensor S1 and the flow sensor S2, a mixed weather-compensated heating circuit can be controlled. Boiler demand via the potential-free relay is triggered depending on the temperature difference between the set flow temperature and the value measured at the backup heating sensor S3.

Sensors		
S1	Outdoor	1/GND
S2	Flow HC	2/GND
S3	Backup heating/ boiler	3/GND
S4	Free	4/GND
S5	Free	5/GND
Relay		
R1	HC pump	R1/N/PE
R2	Mixer open	R2/N/PE
R3	Mixer closed	R3/N/PE
R4	Demand	8/10
0-10V/PWM		
A	Free	6/GND
B	Free	7/GND

Scheme 3: 1 unmixed heating circuit

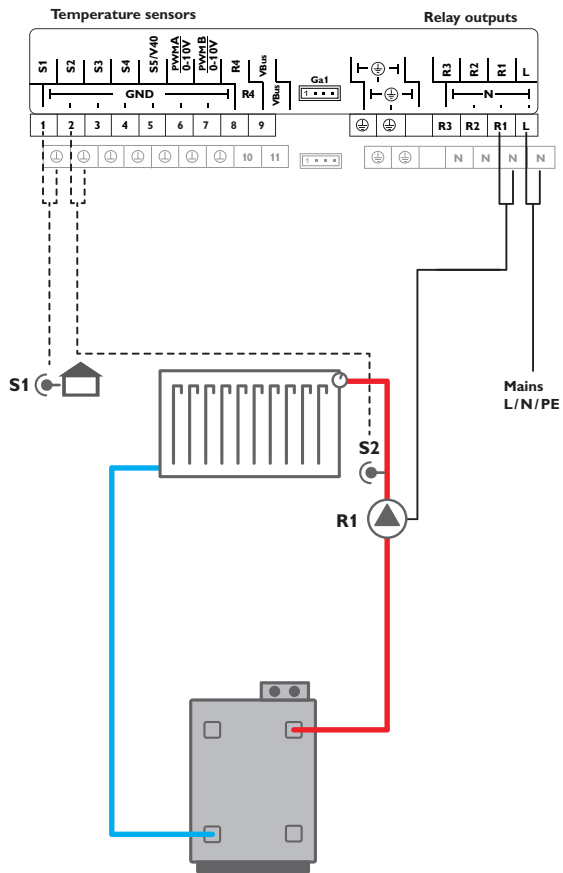

Sensors		
S1	Outdoor	1/GND
S2	Flow HC	2/GND
S3	Free	3/GND
S4	Free	4/GND
S5	Free	5/GND

Relay		
R1	HC pump	R1/N/PE
R2	Free	R2/N/PE
R3	Free	R3/N/PE
R4	Free	8/10

0-10V/PWM		
A	Free	6/GND
B	Free	7/GND

By means of the outdoor temperature sensor S1 and the flow sensor S2, an unmixed weather-compensated heating circuit can be controlled.

Scheme 4: 1 unmixed heating circuit with backup heating (demand)

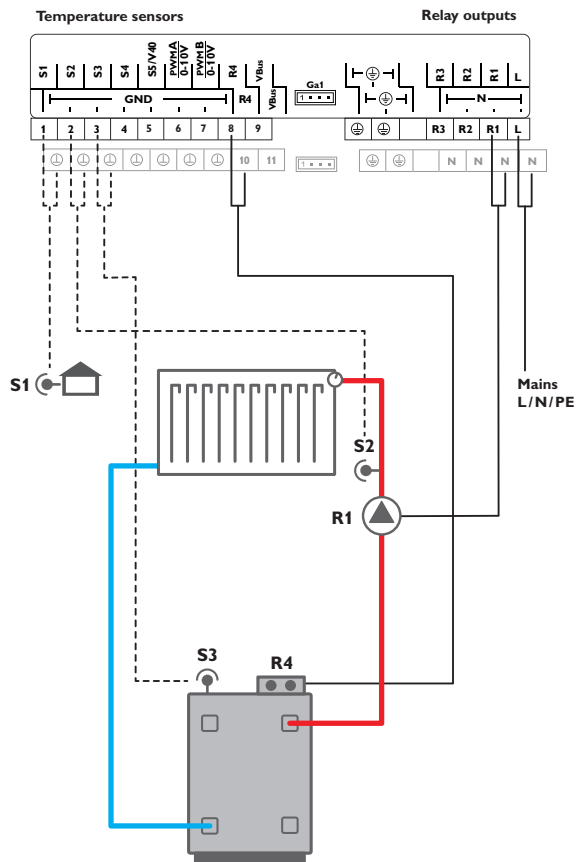

By means of the outdoor temperature sensor S1 and the flow sensor S2, an unmixed weather-compensated heating circuit can be controlled. Boiler demand via the potential-free relay is triggered depending on the temperature difference between the set flow temperature and the value measured at the backup heating sensor S3.

Sensors		
S1	Outdoor	1/GND
S2	Flow HC	2/GND
S3	Backup heating/ boiler	3/GND
S4	Free	4/GND
S5	Free	5/GND
Relay		
R1	HC pump	R1/N/PE
R2	Free	R2/N/PE
R3	Free	R3/N/PE
R4	Demand	8/10
0-10V/PWM		
A	Free	6/GND
B	Free	7/GND

4.2 Step-by-step parameterisation

The heating controller *DeltaTherm*[®] HC mini is a controller that offers a broad variety of functions to the user. At the same time, the user has a lot of freedom in configuring them. Therefore, to set up a complex system, careful planning is required. We recommend drawing a sketch of the system first.

If planning, hydraulic construction and electrical connection have all been carried out successfully, proceed as follows:

1. Running the commissioning menu

After the commissioning menu has been finished (see page 20), further adjustments can be made. The commissioning menu can be repeated any time by means of a reset (see page 56). Additional adjustments will be deleted.

2. Registering modules, sensors and devices

If a flowmeter, a switch, Grundfos Direct Sensors[™], humidity sensors, extension modules and/or room control units are connected, these have to be registered in the **Basic settings / Modules**, **Basic settings / Sensors** and **Basic settings / Devices** menu respectively.

For further information about the registration of modules, sensors and devices see page 56.

3. Adjusting heating circuits and activating optional heating functions

Now the heating circuit can be adjusted.

In combination with extension modules, further heating circuits can be controlled, for the heating part of the arrangement, optional functions can be selected, activated and adjusted.

Heating circuits and their optional functions can use shared relays for (boiler) demands, loading pumps or valves. They have to be selected in the shared relay menu first (see page 31). All free outputs available on the controller and on the modules connected can be used.

The controller always suggests the numerically smallest output available.

Sensors can be allocated to more than one function.

For further information about heating circuits and optional heating functions see page 42.

4. Adjusting the operating mode

After commissioning the heating circuit will be in automatic mode. The operating mode can be changed in the status menu (see page 29).

The operating mode of the first heating circuit also applies to all further heating circuits (via extension modules), if they are linked. If you wish to operate one of the heating circuits 2 ... 7 independently, deactivate the linking of the corresponding heating circuit (see page 29).

5. Activating optional arrangement functions

Now, optional functions for the arrangement can be selected, activated and adjusted: Outputs available can be allocated to functions which require an output. The controller always suggests the numerically smallest output available.

Sensors can be allocated to more than one function.

For further information about the optional arrangement functions see page 47.

5 Menu structure

Main menu

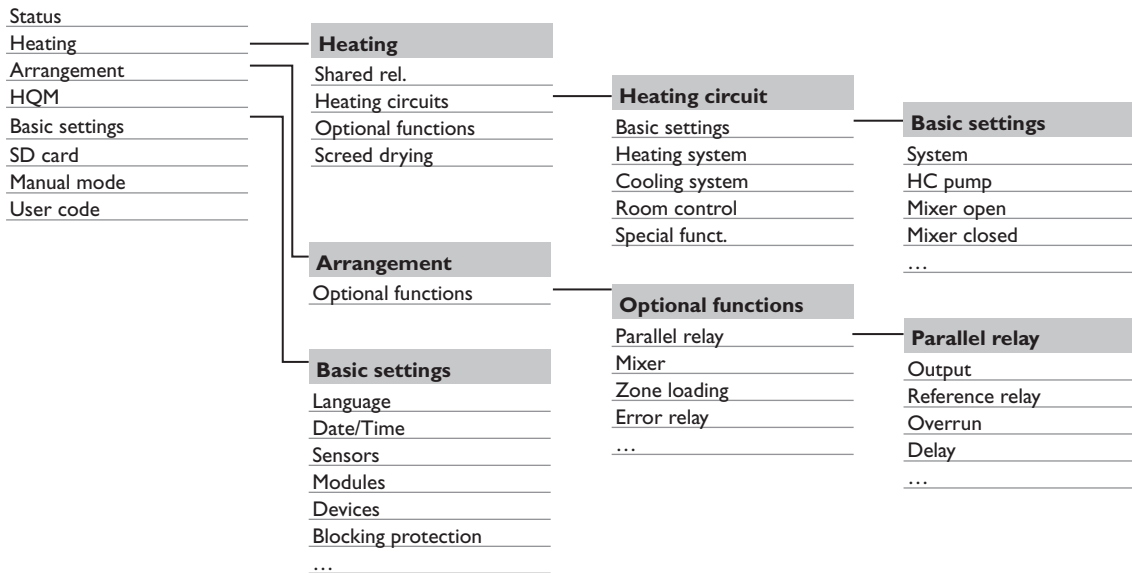

Note

The menu items and adjustment values selectable are variable depending on adjustments already made. The figure only shows an exemplary excerpt of the complete menu in order to visualise the menu structure.

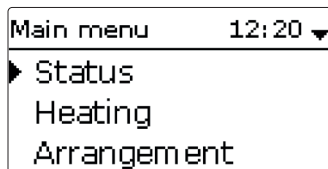

The following menus are available:

- Status
- Heating
- Arrangement
- HQM
- Basic settings
- SD card
- Manual mode
- User code

The following chapters describe the individual menus.



Note

If no button is pressed for 1 min, the display illumination switches off. After 3 further minutes, the controller will display the home screen (see page 30).

In the status menu of the controller, the status messages for every menu area can be found.

At the end of each submenu, the menu item **Adj. values** can be found.

If this one is selected, the corresponding menu opens.

→ In order to get back to the Home Screen (see page 30), push the left button ↵ for 2 s.

7.1 Heating

In this menu, the status of the activated heating circuits as well as of the selected optional functions is indicated.

The status of the first heating circuit is also the home screen of the controller. In this menu, the operating mode of the heating circuit can be changed:

Auto: Automatic heating mode with optionally activated DHW heating and circulation.

Day: Constant heating mode with the adjusted day correction.

Night: Constant heating mode with the adjusted night correction and the selected correction mode.

Summer: The heating circuit is switched off. The optionally activated DHW heating and circulation remain active.

Off: The heating circuit as well as the optionally activated DHW heating and circulation are switched off.

Holiday: Constant heating mode within an adjustable time frame with the adjusted night correction and the selected correction mode.

If the operating mode **Holiday** is selected, the adjustment channel **Holiday** will appear for adjusting the days of an absence. The day, on which the adjustment is made, is the first day of absence. The days will be counted backwards at 00:00. The remaining days are indicated in the status menu (countdown). If 0 is reached, the controller automatically switches to the operating mode Automatic.

The operating mode of the first heating circuit also applies to all further heating circuits (via extension modules), if they are linked. If you wish to operate one of the heating circuits 2 ... 7 independently, deactivate the linking of the corresponding heating circuit (see page 41).

7.2 Arrangement

This menu shows all status information of all activated optional functions of the arrangement.

7.3 HQM

In this menu, all current measured values of the flow and return sensors, flow rate and power as well as heat quantities are indicated.

Furthermore, the impulse counter values are indicated.

7.4 Measured / Balance values

This menu shows all current measurement values as well as a range of balance values. Some of the menu items can be selected in order to enter a submenu.

Each sensor and output is indicated with the component or function it has been allocated to. The symbol ► at the edge of the display next to a sensor allocated to a function, means that this sensor has several functions. Use the Lightwheel® to scroll to these functions. The sensors and outputs of the controller and all modules connected are listed in numerical order.

7.5 Messages

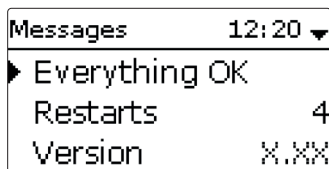

This menu shows error and warning messages.

During normal operation, the message **Everything OK** is indicated.

When a monitoring function from the function control is activated and detects a fault condition, a corresponding message will be indicated (see table page 30).

A message consists of the name of the monitoring function, a 4-digit error code and a short text description of the fault condition.

In order to acknowledge a message, proceed as follows:

1. Select the code line of the desired message by turning the Lightwheel®.
2. Confirm the message with the right button (✓).
3. Confirm the security enquiry by with **Yes**.

When the installer user code has been entered, the menu item **Restarts** will appear below the messages. The value indicates the number of controller restarts since commissioning. This value cannot be reset.

Error code	Display	Monitoring function	Cause
0001	!Sensor fault	Sensor line break	Sensor line broken
0002	!Sensor fault	Sensor short circuit	Sensor line short-circuited
0041	!Flow rate monit.	Flow rate monitoring	No flow at sensor
0051	!Overpressure	Overpressure monitoring	Max. system pressure exceeded
0052	!Low pressure	Low pressure monitoring	System pressure below minimum
0061	!Data storage def.	Storing and changing adjustments not possible	
0071	!RTC module def.	Time-controlled functions (e.g. night correction) not possible	Incorrect date and time settings due to power failure or defective RTC module
0091	Restarts	Restart counter (non-adjustable)	Number of restarts since commissioning



Note

A power failure can lead to incorrect date and time settings. In this case, the message about a defective RTC module will be displayed.

- ➔ In order to rectify the error, check the date and time settings and adjust again, if necessary.

7.6 Home screen

In this menu, the menu which will appear if no button is pressed for a longer period of time can be selected.

For the pre-programmed schemes, the status of the heating circuit (1) is preset as the home screen.

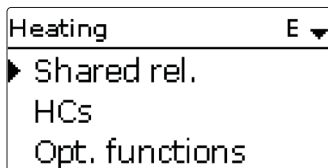

In this menu, all adjustments for the heating part of the arrangement or for the heating circuit respectively can be made.

In combination with extension modules, further heating circuits can be controlled, for the heating part of the arrangement, optional functions can be selected, activated and adjusted.

Shared relays for demands, loading pumps or valves can be activated and adjusted. In this menu, the screed drying function can be activated and adjusted.

8.1 Shared relays

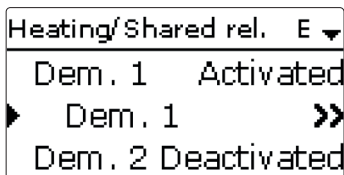

In this menu, adjustments for heat generators, loading pumps and valves which are shared by several heating circuits and their optional functions can be made.

Further options such as boiler protection, start-up and overrun are also available.

Shared relays will be available for selection under **Virtual** in the heating circuits and in the relay allocation channels of the corresponding optional functions of the Heating menu. This way, several heating circuits and optional functions (heating) can demand the same heat source.



Note

Activate and adjust the shared relays first. They will then be available in the heating circuits and optional functions.

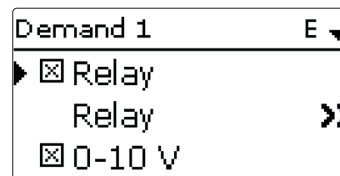

Heating / Shared rel.

Adjustment channel	Description	Adjustment range / selection	Factory setting
Dem. 1 (2)	Demand 1 (2)	Activated, Deactivated	Deactivated
Dem. 1 (2)	Demand submenu	-	-
Relay	Relay option	Yes, No	No
Relay	Relay submenu	-	-
Relay	Relay selection	system dependent	system dependent
Boiler pr. min	Option for boiler protection min	Yes, No	No
TMin	Minimum boiler temperature	10 ... 90 °C	55 °C
Boiler pr. max	Option for boiler protection max	Yes, No	No
TMax	Maximum boiler temperature	20 ... 95 °C	90 °C
Sen. boiler	Boiler sensor selection	system dependent	S3
0-10V	0-10V option	Yes, No	No
0-10V	0-10V submenu	-	-
Output	Output selection	-, A, B	-
TSet 1	Lower boiler temperature	10 ... 85 °C	10 °C
Volt 1	Lower voltage	1.0 ... 10.0V	1.0V
TSet 2	Upper boiler temperature	15 ... 90 °C	80 °C
Volt 2	Upper voltage	1.0 ... 10.0V	8.0V
Permanent volt.	Permanent voltage option	Yes, No	No
Volt	Permanent voltage value	0.1 ... 9.9V	2.0V
TMin	Minimum value set boiler temperature	10 ... 89 °C	10 °C
TMax	Maximum value set boiler temperature	11 ... 90 °C	80 °C
ΔTFlow	Increase for the set flow temperature	0 ... 20 K	5 K
Sen. flow	Flow sensor option	Yes, No	No
Sensor	Flow sensor selection	system dependent	-
Interval	Monitoring period	10 ... 600 s	30 s
Hysteresis	Correction hysteresis	0,5 ... 20,0K	1.0 K
Correction	Correction of the voltage signal	0.0 ... 1.0V	0.1V

Adjustment channel	Description	Adjustment range / selection	Factory setting
Min. runt.	Minimum runtime option	Yes, No	No
tMin	Minimum runtime	0 ... 120 min	10 min
Manual mode	Operating mode for shared relays	Max., Auto, Off, Min.	Auto
Pump 1 (2)	Shared relay option for loading pump	Activated, Deactivated	Deactivated
Pump 1 (2)	Pump submenu	-	-
Output	Output selection	system dependent	system dependent
Delay	Pump delay	No, Time, Temp.	No
TO _n	Boiler start-up temperature	10 ... 90 °C	60 °C
Duration	Delay to a demand	0 ... 300 s	60 s
Overrun	Pump overrun	No, Time, Temp.	No
TO _{ff}	Remaining boiler temperature	10 ... 90 °C	50 °C
Duration	Delay to a demand	0 ... 300 s	60 s
Sen. boiler	Boiler sensor selection	system dependent	system dependent
Manual mode	Manual mode of output	Max., Auto, Min., Off	Auto
Valve 1 (2)	Shared relay option for valve	Activated, Deactivated	Deactivated
Valve 1 (2)	Valve submenu	-	-
Output	Output selection	system dependent	system dependent
Manual mode	Manual mode of output	Max., Auto, Min., Off	Auto

back

Every demand can be carried out by means of a relay and/or a 0-10V output. If both the **Relay** and the **0-10 V** option are activated, the demand uses both outputs in parallel.

Example:

The potential-free relay R4 can be allocated to the shared relay **Dem. 1**, for example. R4 will then become available for potential-free boiler demand in the heating circuits and e.g. the DHW heating function.

Relay option

If the **Relay** option is activated, the submenu **Relay** appears, in which a relay can be allocated to the demand.

The **Boiler pr. min** option is used for protecting a boiler against cooling. If the temperature falls below the adjusted minimum temperature, the allocated relay will be energised until the minimum temperature is exceeded by 5 K.

The **Boiler pr. max** option is used for protecting a boiler against overheating. If the adjusted maximum temperature is exceeded, the allocated relay will be switched off until the temperature falls by 5 K below the maximum temperature.

For this purpose, a boiler sensor is required.

0-10 V option

If the **0-10 V** option is activated, the submenu **0-10 V** appears, in which a 0-10 V output can be allocated to the demand.

With this option, the controller can demand modulating heat generators equipped with a 0-10 V interface.

The characteristic curve of the 0-10V signal as a function of the set boiler temperature is defined by means of 2 set points according to the specifications of the boiler manufacturer. At a temperature of **TSet 1**, the voltage signal of the heat generator is **Volt 1**. At a temperature of **TSet 2**, the voltage signal of the heat generator is **Volt 2**. The controller automatically calculates the characteristic curve resulting from these values. If the **permanent voltage** option is activated, the parameter **Volt** appears, by means of which a minimum voltage that is permanently applied to the output can be defined.

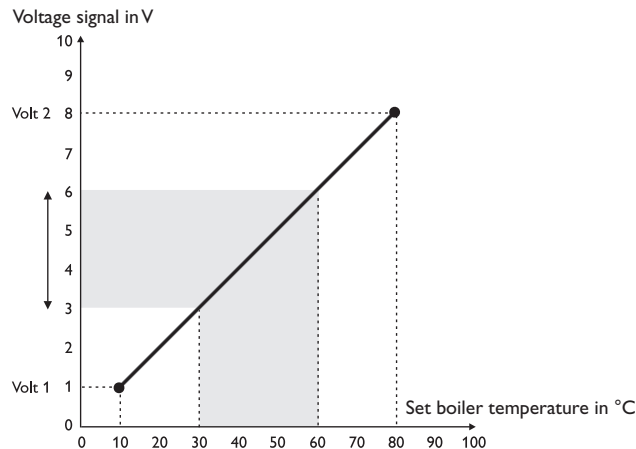

By means of the adjustment channels **TMax** and **TMin** the maximum and minimum values for the set boiler temperature can be defined.

When the **Sen. flow** option is activated, the controller monitors whether the heat generator actually reaches the desired set temperature and, if necessary, adjusts the voltage signal accordingly. In order to do so, the controller checks the temperature at the boiler flow sensor when the interval has elapsed. If the temperature measured deviates from the set boiler temperature by more than the hysteresis, the voltage signal is adapted by the **Correction** value. This process will be repeated

until the temperature measured is identical to the set boiler temperature. When the **Min. runtime** option is activated, a minimum runtime can be adjusted for the demand.

Pump

For loading pumps, the shared relays **Pump 1** and **Pump 2** are available. Concerning a demand, the options **Delay** and **Overrun** can be activated for the shared relays. The demand can either be time- or temperature controlled. For temperature-dependent control an allocated boiler sensor is required.

The **Delay** option is used for switching on the loading pump with a delay to a demand. If the adjusted minimum temperature at the allocated sensor is exceeded or the adjusted duration has elapsed, the allocated output switches on. The **Overrun** option is used for switching off the loading pump with a delay to a demand. If the temperature falls below the adjusted remaining boiler temperature or the adjusted duration has elapsed, the allocated output switches off.

Valve

Valves and parallel relays can use the shared relays **Valve 1** and **Valve 2**. These shared relays are energised individually or along with a reference relay (e.g. loading pump).



Note

If the 0-10V demand is used for DHW heating, the voltage signal will always be identical to **TMax**.

8.2 Heating circuits

The controller has 1 mixed weather-compensated heating circuit and is able to control up to 6 further external mixed heating circuits by means of extension modules.

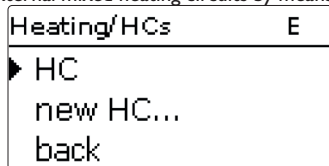

If one or more extension modules are connected, they have to be registered with the controller. Only registered modules will be available in the heating circuit selection.

If **new HC...** is selected for the first time, the first heating circuit is allocated to the controller.

Heating / HCs / new HC...

Adjustment channel	Description	Adjustment range / selection	Factory setting
Basic settings	Basic settings submenu (see page 33)	-	-
Heating system	Heating system submenu (see page 34)	-	-
Cooling system	Cooling system submenu (see page 37)	-	-
Room control	Room control submenu (see page 39)	-	-
Special funct.	Special functions submenu (see page 39)	-	-
Funct.	De/activation of the heating circuit	Activated, Deactivated, Switch	Activated
Sensor	Switch input selection	-	-

8.2.1 Basic settings submenu

In this menu, relays for the heating circuit pump and the heating circuit mixer can be selected.

3 relays are required for a mixed heating circuit.

In the **System** parameter, a selection can be made between **Heat**, **Cool** and **Heat/Cool**.

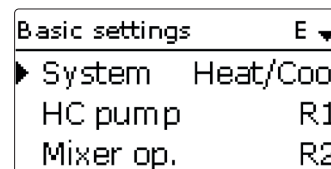

If the measured flow temperature deviates from the set flow temperature, the mixer will be activated in order to adjust the flow temperature correspondingly.

The mixer runtime can be adjusted with the parameter **Interval**.

Heating / HCs / new HC... / Basic settings

Adjustment channel	Description	Adjustment range / selection	Factory setting
System	Heating circuit mode selection	Heat, Cool, Heat/Cool	Heat
HC pump	Heating circuit pump output selection	system dependent	system dependent
Mixer op.	Output selection mixer open	system dependent	system dependent
Mixer cl.	Output selection mixer closed	system dependent	system dependent
Interval	Mixer interval	1...20s	4 s
Sen. outd.	Outdoor sensor selection	system dependent	system dependent
Sen. flow	Flow sensor selection	system dependent	system dependent

8.2.2 Heating system submenu

Heat. sys.	E ▾
▶ Mode	Curve
Curve	1.0
TFlowmin	20 °C

In this menu, a mode for the heating circuit control can be selected and adjusted.

5 modes are available:

- Constant
- Curve
- Linear
- Room influence
- Room

The **Constant** mode aims to keep the set flow temperature at a constant value which can be adjusted by means of the parameter **TFlowset**.

Set flow temperature = TFlowset + remote control + day correction or night correction

If the **Curve** mode is selected, the controller calculates a set flow temperature by means of the outdoor temperature and the heating curve selected. In both cases, the dial setting of the remote control and the controller day correction or night correction will be added.

Set flow temperature = heating curve temperature + remote control + day correction or night correction

The calculated set flow temperature is limited by the adjusted values for the maximum flow temperature and the minimum flow temperature.

Maximum flow temperature \geq set flow temperature \geq minimum flow temperature

By means of the adjustment channels **TFlowmax** and **TFlowmin** the maximum and minimum values for the set flow temperature can be defined.

If the outdoor temperature sensor is defective, an error message will be indicated. For the duration of this condition, the maximum flow temperature -5K is assumed as the set flow temperature in the **Curve** and **Linear** mode.



Note

The controller uses an averaged outdoor temperature.

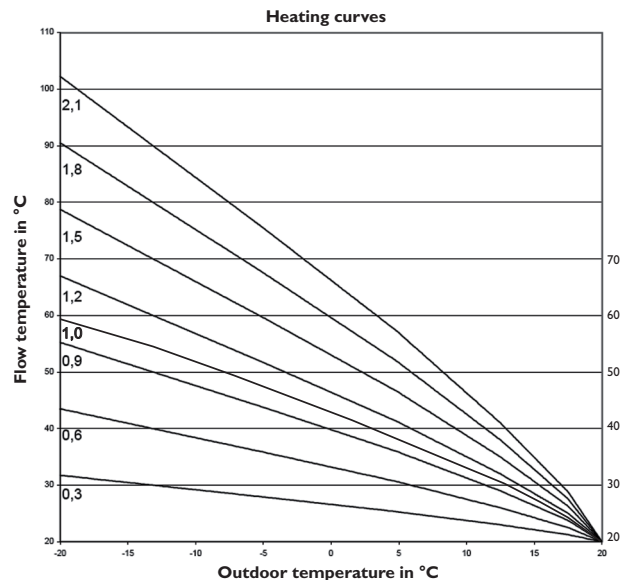

In the **Linear** mode the flow temperature curve will be calculated by means of 2 points depending on the outdoor temperature. At a temperature of **TOutdoor 1** the set flow temperature is **TFlow 1**. At a temperature of **TOutdoor 2** the set flow temperature is **TFlow 2**. The controller automatically calculates the characteristic curve resulting from these values.

Heat. sys.	E ▾
▶ Mode	Room infl.
Curve	1.0
Room factor	5

In the **Room influence** mode, the weather-compensated set flow temperature will be expanded by a demand-based room control. The parameter **Room factor** can be used for determining the intensity of the room influence.

The controller calculates the set flow temperature as in the curve mode plus the room influence: Set flow temperature = set temperature + remote control + day correction or night correction + room influence

In order to calculate the deviation of the room temperature from the adjusted set value, at least one sensor-type room is required. The adjustments can be made in the **Room control** submenu.

Heat. sys.	E
▶ Mode	Room
TStart	40 °C
TFlowmin	20 °C

In the **Room** mode, the controller will calculate the set flow temperature by means of the room temperature, the outdoor temperature will not be taken into account. Day/Night correction and timer will not be indicated.

The start value of the set flow temperature can be influenced by the parameter **TStart**.

In order to calculate the deviation of the room temperature from the adjusted set value, at least one room is required (see page 39). The adjustments can be made with the **Room (1 ... 5)** parameter. For this purpose, select **Sensor** in the **Type** adjustment channel.

The adjustments of all activated room will be taken into account. The controller will calculate the average value of the deviations measured and correct the set flow temperature correspondingly.

Timer

With the timer, the day/correction operation can be adjusted. During day phases, the set flow temperature is increased by the adjusted day correction.

Heat. sys.	E
☒ Timer	
Mode	Day/Night
▶ Timer	>>

The parameter **Mode** is used for selecting between the following correction modes:

Day/Night: A reduced set flow temperature (night correction) is used during night operation.

Day/Off: The heating circuit and the optionally activated backup heating are switched off during night operation.

The timer can be used for adjusting the time frames for day operation.

Summer operation

Heat. sys.	E
▶ ☒ Summer oper.	
Mode	Day
TDay off	20 °C

In summer mode, the heating circuit is switched off.

For summer operation, the following modes are available:

Day: If the outdoor temperature exceeds the summer temperature day, the heating circuit switches off.

Day/Night: The parameters **Daytime on** and **Daytime off** can be used for adjusting a time frame for the summer operation. If the outdoor temperature exceeds the summer temperature night outside the adjusted time frame, the heating circuit switches off as well.

Date: In this mode, a date with start and stop can be adjusted for the summer operation.

Date/Day: In this mode, a date with start and stop can be adjusted for the summer operation. If the outdoor temperature exceeds the summer temperature day outside the adjusted period, the heating circuit switches off as well.

Dt./d/n: In this mode, a date with start and stop can be adjusted for the summer operation additionally to the day/night temperature.

Backup heating

For the backup heating of the heating circuit, 3 modes are available:

Therm.: In this mode, the set flow temperature is compared to a store reference sensor.

Zone: In this mode, the set flow temperature is compared to 2 store reference sensors. The switching conditions have to be fulfilled at both reference sensors.

On/Off: In this mode, the backup heating is activated when the heating circuit pump is switched on for heating.

Backup heating		E	▼
▶ Mode	Zone		
Output	Dem.1		
Sensor 1	S4		

In the **Output** submenu, the modes **Standard** and **Demand** are available. If **Standard** is selected, the output can be adjusted.

If **Demand** is selected, a demand has to be activated and adjusted in the **Heating /Shared rel.** menu first. If **Adj. values** is selected, the **Heating /Shared rel./Demand** will open.

In the correction mode **Day/Off** (see page 35) the heating circuit and the backup heating will be completely switched off during the night operation. The starting optimisation can be used for activating the backup heating before the day operation in order to heat the store to a sufficiently high temperature. The stopping optimisation can be used for deactivating the backup heating before the start of the night operation.

Backup heating		E	▲
▶ Loading pump	A		
<input type="checkbox"/> Start. opt.			
<input type="checkbox"/> Stopp. opt.			

With an extension module, the **SFB off** function is available. If **SFB off** is activated, backup heating is suppressed when a selected solid fuel boiler is active.

Backup heating		E	▲
▶ <input checked="" type="checkbox"/> SFB off			
SFB	1		
Funct.	Activated		

Heating / HCs / new HC... / Heat. sys.

Adjustment channel	Description	Adjustment range / selection	Factory setting
Heat. sys.	Heating system submenu	-	-
Mode	Heating system operating mode	Linear, Constant, Curve, Room, Room infl.	Curve
Curve	Heating curve	0.3 ... 3.0	1.0
Room factor	Room influence factor	1 ... 9	5
TFlowset	Set flow temperature	10 ... 90 °C	45 °C
TOutdoor 1	Lower outdoor temperature	-20 ... +20 °C	+20 °C
TFlow 1	Lower set flow temperature	20 ... 90 °C	20 °C
TOutdoor 2	Upper outdoor temperature	-20 ... +20 °C	-20 °C
TFlow 2	Upper set flow temperature	20 ... 90 °C	70 °C
TStart	Starting temperature	20 ... 60 °C	40 °C
TFlowmin	Minimum flow temperature	20 ... 89 °C	20 °C
TFlowmax	Maximum flow temperature	21 ... 90 °C	50 °C
Pump off	Deactivation of the heating circuit pump when TFlowmax is exceeded	Yes, No	No
Day corr.	Correction for day operation	-5 ... +45 K	0 K
Night corr.	Correction for night operation	-20 ... +30 K	-5 K
Timer	Timer function correction mode	Yes, No	No
Mode	Correction mode	Day/Night, Day/Off	Day/Night
Timer	Timer function submenu	-	-
Summer oper.	Summer operation option	Yes, No	Yes
Mode	Summer operating mode	Day, Day/Night, Date, Date/Day, Dt./d/n	Day
Start	Date adjustment	01.01 ... 31.12.	01.04.
Stop	Date adjustment	01.01 ... 31.12.	30.09.
TDay off	Summer temperature day	0 ... 40 °C	20 °C
TNight off	Summer temperature night	0 ... 40 °C	14 °C
Daytime on	Day time frame on	00:00 ... 23:45	09:00
Daytime off	Day time frame off	00:00 ... 23:45	21:00

Adjustment channel	Description	Adjustment range / selection	Factory setting
Backup heating	Backup heating option	Yes, No	No
Backup heating	Backup heating submenu	-	-
Mode	Backup heating mode selection	Therm., Zone, On/Off	Therm.
Output	Output selection	system dependent	system dependent
Mode	Relay or shared relay	Standard, Demand	Standard
Sensor 1	Allocation reference sensor 1	system dependent	system dependent
Sensor 2	Allocation reference sensor 2 (if Mode = Zone)	system dependent	system dependent
ΔT_{On}	Switch-on temperature difference	-15.0 ... 44.5 K	5.0 K
ΔT_{Off}	Switch-off temperature difference	-14.5 ... 45.0 K	15.0 K
Loading pump	Boiler loading pump output selection	system dependent	system dependent
Start. opt.	Starting optimisation option	Yes, No	No
Time	Starting optimisation time	0 ... 300 min	60 min
Stopp. opt.	Stopping optimisation option	Yes, No	No
Time	Stopping optimisation time	0 ... 300 min	60 min
SFB off	Solid fuel boiler off option	Yes, No	No
SFB	Allocation solid fuel boiler	all solid fuel boilers	-
Funct.	De/activation of the heating circuit	Activated, Deactivated, Switch	Activated
Sensor	Switch input selection	-	-

8.2.3 Cooling system submenu

In this menu, the cooling logic can be adjusted.

For the cooling logic, 2 modes are available:

- Linear
- Constant

Cooling system	E	Cooling system	E
▶ Mode	Constant	▶ Mode	Linear
TFlowset	20 °C	TOutdoor 1	20 °C
TFlowmin	10 °C	TFlow 1	20 °C

In the **Linear** mode, the set flow temperature will be calculated as in the heating system mode **Linear**.

The **Constant** mode aims to keep the set flow temperature at a constant value which can be adjusted by means of the parameter **TFlowset**.

For activating cooling, 3 modes are available:

- Outdoor
- External switch
- Outdoor/Switch

In the **Outdoor** mode, cooling is activated if the outdoor temperature cooling is exceeded.

In the **Ext. switch** mode, cooling is activated by means of an external switch.

In the **Outd./Switch** mode, both switching conditions are valid for cooling.

If the **Timer** option is activated, a time frame can be adjusted in which the cooling will be active.

Dew point

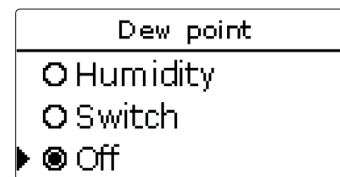

The **Dew point** option is used for avoiding condensation. For this function, 3 variants are available:

- Humidity
- Switch
- Off

When **Humidity** is selected, the controller calculates the dew point by means of the humidity sensor.

The minimum flow temperature results from the dew point plus the adjustable correction value. The **emergency shutdown** option is used for switching off the cooling, if the adjustable relative humidity is exceeded. The re-energise hysteresis for this function can be adjusted. An output can be selected which is activated during an emergency shutdown, e.g. to switch on a fan.

When **Switch** is selected, an input as well as an output can be allocated to a dew point switch. If the dew point switch detects condensation, cooling is interrupted. If **Off** is selected, the **Dew point** option is switched off.

Backup cooling

Backup cooling	E
Mode	Therm.
Output	R4
Sensor	S5

For the backup cooling of the heating circuit, 4 modes are available:

Therm.: In this mode, the set flow temperature is compared to a store reference sensor.

Zone: In this mode, the set flow temperature is compared to 2 store reference sensors. The switching conditions have to be fulfilled at both reference sensors.

On/Off: In this mode, the backup cooling is activated when the heating circuit pump is switched on for heating.

Absolute: In this mode, a switch-on and a switch-off temperature for a reference store sensor can be adjusted.

The backup cooling is activated when the switch-on temperature at sensor 1 is exceeded. The backup cooling switches off when the switch-off temperature is reached.

In the **Output** submenu, the modes **Standard** and **Demand** are available. If **Standard** is selected, the output can be adjusted.

If **Demand** is selected, a demand has to be activated and adjusted in the **Heating / Shared rel.** menu first. If **Adj. values** is selected, the **Heating / Shared rel./Demand** will open.

Heating / HCs / new HC... / Cooling system

Adjustment channel	Description	Adjustment range / selection	Factory setting
Cooling system	Cooling system submenu	-	-
Mode	Cooling mode	Linear, Constant	Constant
TFlowset	Cooling set flow temperature	5... 25 °C	20 °C
TFlowmin	Minimum flow temperature	5... 29 °C	10 °C
TOutdoor 1	Lower outdoor temperature	15... 45 °C	20 °C
TFlow 1	Lower set flow temperature	5... 25 °C	20 °C
TOutdoor 2	Upper outdoor temperature	15... 45 °C	40 °C
TFlow 2	Upper set flow temperature	5... 25 °C	10 °C
TFlowmin	Minimum flow temperature	5... 29 °C	10 °C
TFlowmax	Maximum flow temperature	6... 30 °C	25 °C
Output	Output selection	system dependent	system dependent

Adjustment channel	Description	Adjustment range / selection	Factory setting
Mode	Cooling mode	Outdoor, Ext. switch, Outd./Switch	Outdoor
Sensor	Switch input selection	system dependent	-
Inverted	Inverted switching option	Yes, No	No
TDay off	Outdoor temperature cooling	20... 40 °C	28 °C
Timer	Timer function cooling	Yes, No	No
tOn	Switch-on time cooling	00:00... 23:45	00:00
tOff	Switch-off time cooling	00:00... 23:45	00:00
Dew point	Dew point monitoring option	Humidity, Switch, Off	Off
Sensor	Sensor input selection	system dependent	system dependent
Output	Output selection	system dependent	system dependent
Correction	Correction value	0... 10 K	2 K
Emerg. shutd.	Emergency shutdown option	Yes, No	No
Humidity	Relative humidity	5... 100%	95%
Hysteresis	Re-energise hysteresis	1... 10%	5%
Output	Output selection	system dependent	system dependent
Backup cooling	Backup cooling option	Yes, No	No
Backup cooling	Backup cooling submenu	-	-
Mode	Backup cooling mode selection	Absolute, Therm., Zone, On/Off	Therm.
Output	Output selection	system dependent	system dependent
Sensor 1	Allocation reference sensor 1	system dependent	system dependent
Sensor 2	Allocation reference sensor 2 (if Mode = Zone)	system dependent	system dependent
ΔTOn	Switch-on temperature difference	-44,5... +15,0 K	-2.0 K
ΔTOff	Switch-off temperature difference	-45,0... +14,5 K	-7.0 K
TOn	Switch-on temperature	-13... +44 °C	+12 °C
TOff	Switch-off temperature	-14... +43 °C	+8 °C
Loading pump	Boiler loading pump output selection	system dependent	system dependent
Start. opt.	Starting optimisation option	Yes, No	No
Time	Starting optimisation time	0... 300 min	60 min
Stopp. opt.	Stopping optimisation option	Yes, No	No
Time	Stopping optimisation time	0... 300 min	60 min
Funct.	De/activation of the heating circuit	Activated, Deactivated, Switch	Activated
Sensor	Switch input selection	-	-

8.2.4 Room control submenu

Room control	E	▼
▶ <input checked="" type="checkbox"/> Room 1		
Type	Sensor	
Sen. room	S5	

Up to 5 rooms can be integrated into the control logic.

To each room, a sensor input can be allocated. If the measured temperature exceeds the adjusted set room temperature in all activated rooms and if the parameter **HC off** is activated, the heating circuit switches off.

When a room control unit of the RC type is used (see page 57), the set room temperature has to be adjusted directly at the room control unit, the parameter **TAmb.set** is then hidden. The RC type room control unit also measure the relative humidity as well as the room temperature. The controller uses these values for calculating the dew point.

Common room thermostats with potential-free outputs can be used alternatively. In this case, **Switch** must be selected in the **Type** channel.

When the **Timer** option is activated, a timer is indicated in which time frames for the function can be adjusted. Outside these time frames, the adjusted room temperature is decreased by the correction value.

If the heating circuit is in cooling mode, the set room temperature is increased by the correction value.



Note

For information on timer adjustment see page 13.

To each room, an additional output can be allocated. The output switches on when the temperature falls below the adjusted room temperature. This way, the room in question can be excluded from the heating circuit via a valve as long as the desired room temperature is reached.

Heating / HCs / new HC... / Room control

Adjustment channel	Description	Adjustment range / selection	Factory setting
Room control	Room control submenu	-	-
Room 1...5	Room option (1...5)	Yes, No	No
Type	Room sensor type selection	Sensor, Switch	Sensor
Sen. room	Room sensor allocation	system dependent	system dependent

Adjustment channel	Description	Adjustment range / selection	Factory setting
TAmb.set	Set room temperature	10...30 °C	18 °C
Hysteresis	Hysteresis	0,5...20,0K	0,5 K
Timer	Timer function	Yes, No	No
Timer	Timer function submenu	-	-
Correction	Correction value	1...20K	5 K
Output	Output selection	system dependent	system dependent
Func.	De/activation of the function	Activated, Deactivated, Switch	Activated
HC off	Heating circuit off option	Yes, No	No

8.2.5 Special functions submenu

In this menu, special functions for the heating circuit can be adjusted.

Remote access

With the parameter **Remote access** different types of remote access to the controller can be activated.

Special functions	E	▼
▶ <input checked="" type="checkbox"/> Remote access		
Mode	BAS	
Sen. BAS	S5	



Note

In the sensor selection menu, only outputs which have previously been selected as the input for remote access in the **Basic settings** menu will be available. In the **Sensor config** channel, sensors not used and not registered can be selected.

The following types of remote access are possible:

Remote control: A device which allows manual adjustment of the heating curve, thus influencing the set flow temperature.

→ In order to use a remote control, set the **Mode** to **Fern**.

The remote control allows manual adjustment of the heating curve ($\pm 15K$). Furthermore, the heating circuit can be switched off or a rapid heat-up can be carried out by means of the remote control.

Heating circuit switched off means that the heating circuit pump is switched off and the mixer closed. The flow temperature is boosted to maximum for rapid heat-up when the remote control is set to rapid heat-up.

Room control unit: A device incorporating a remote control as well as an additional operating mode switch.

→ In order to use a room control unit, set the **Mode** to **BAS**.

The operating mode switch of the room control unit is used for adjusting the operating mode of the controller. If a room control unit is used, the operating mode can be adjusted by means of the room control unit only. The status menu will only allow the activation of the operating mode **Holiday**.

App: If **App** is selected, remote access as with a remote control or room control unit via an app is possible.

If **Fern** or **BAS** is adjusted, read access is possible with the app.

→ In order to use an app, set the **Mode** to **App**.

If you use an app, the operating mode can be adjusted in the controller menu as well as in the app.

DHW priority

If the parameter **DHW priority** is activated, the heating circuit will be switched off and the backup heating be suppressed as long as DHW heating takes place which has previously been activated in the **Heating / Optional functions** menu.

Chimney sweeper function

The chimney sweeper function can be used for enabling a quick access to measurement conditions without menu operation for the chimney sweeper.

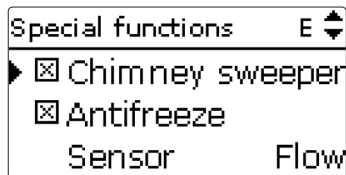

The chimney sweeper function is activated in all heating circuits by default. The chimney sweeper mode can be activated by pressing microbutton .

In the chimney sweeper mode, the heating circuit mixer opens, the heating circuit pump and the backup heating contact are activated. While the chimney sweeper mode is active, the operating control LED is flashing red. Additionally, **Chimney sweeper** and a countdown of 30 min are indicated on the display.

When the countdown has elapsed, the chimney sweeper mode is automatically deactivated. If, during the countdown, microbutton  is pressed again, the chimney sweeper mode will stop.

Antifreeze function

The antifreeze function of the heating circuit can be used to temporarily activate an inactive heating circuit during sudden temperature drop in order to protect it against frost damage.

The temperature at the sensor selected will be monitored. If the temperature falls below the adjusted antifreeze temperature, the heating circuit will be activated until the antifreeze temperature is exceeded by 2 K, but at least for 30 min.

Heat dump option

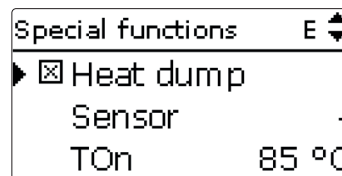

This option is used for diverting excess heat to the heating circuit in order to keep the system temperatures within the operating range. If the temperature at the allocated sensor exceeds the switch-on temperature, the set flow temperature is controlled to reach the adjusted value. If the temperature falls below the adjusted switch-off temperature, the heat dump function switches off.

This option is not available, if a heating circuit mode for cooling or cooling and heating has been selected.

Holiday option

If the **Holiday** option is activated, the heating circuit switches into the correction mode.

→ In order to adjust the days of absence, press and hold down microbutton  for 3 s.

Energy saving operation

Special functions	E
☒ Energy saving	
Sen. return	S4
ΔTOff	4 K

This option is used for optimising the energy consumption of the heating circuit pump. For this purpose an additional sensor in the heating circuit return is required. The controller monitors the temperature difference between the flow and the return of the heating circuit. If the temperature difference falls below the switch-off difference, the controller deactivates the heating circuit pump for the adjusted break time. After the break time has elapsed, the pump is activated for the runtime. If the temperature difference is higher than the switch-off difference, the pump remains active. If the temperature difference is below the switch-off difference, the break time will start again.

HC linking

Beginning with the second heating circuit, all heating circuits offer the parameter **HC linking**. Using this parameter, the heating circuits adopt the operating mode of the first heating circuit. If you wish to adjust the operating mode of the heating circuits separately, deactivate the linking option.

Heating / HCs / new HC... / Special funct.

Adjustment channel	Description	Adjustment range / selection	Factory setting
Special funct.	Special functions submenu	-	-
Remote access	Remote access option	Yes, No	No
Mode	Remote access mode	BAS, Fern, App	BAS
Sen. BAS	Allocation operating mode switch input	all inputs type = BAS	-
Sen. RC	Allocation remote control input	all inputs type = Fern	-
DHW priority	DHW priority option	Yes, No	No
Chimney sweeper	Chimney sweeper option	Yes, No	Yes
Antifreeze	Antifreeze option	Yes, No	Yes
Sensor	Antifreeze sensor	Flow, Outdoor	Flow
TAntifr.	Antifreeze temperature	-20 ... +10 °C (Outdoor)	+2 °C (Outdoor)
		4 ... 10 °C (Flow)	+5 °C (Flow)
TFlowset	Set flow temperature antifreeze	20 ... 50 °C	20 °C
Heat dump	Heat dump option	Yes, No	No
Sensor	Allocation heat dump sensor	system dependent	system dependent
TOn	Switch-on temperature heat dump	25 ... 95 °C	85 °C
TOff	Switch-off temperature heat dump	20 ... 90 °C	50 °C
TFlowset	Set flow temperature heat dump	5 ... 90 °C	50 °C
Holiday	Heating in correction mode when holiday function is active	Yes, No	No
Energy saving	Energy saving operation option	Yes, No	No
Sen. return	HC return sensor allocation	system dependent	system dependent
ΔTOff	Switch-off temperature difference energy saving operation	1 ... 49K	4 K
Break	Break time energy saving operation	0 ... 60 min	15 min
Runtime	Runtime energy saving operation	0 ... 60 min	2 min
HC linking	Linking option Operating mode (HC2 ... 7)	Yes, No	Yes

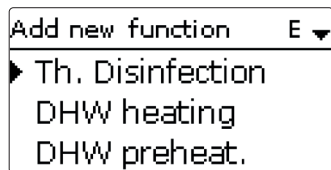

In this menu, optional functions can be selected and adjusted for the heating part of the arrangement.

In combination with extension modules, up to 16 optional functions can be selected and adjusted.

The kind and number of optional functions offered depends on the previous adjustments.

In the **Demand** submenu (if available), the modes **Standard** and **Demand** are available. If **Standard** is selected, the output can be adjusted.

If **Demand** is selected, a demand has to be activated and adjusted in the **Heating / Shared rel.** menu first.



Note

For further information about adjusting optional functions, see page 15.



Note

For information on the output selection see page 17.

Thermal disinfection

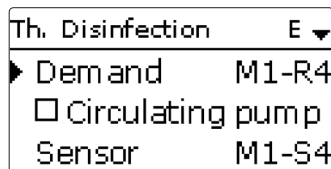

This function helps to contain the spread of Legionella in DHW stores by systematically activating the backup heating.

One sensor and one output or demand respectively can be selected for this function.

For thermal disinfection, the temperature at the allocated sensor has to be monitored. Protection is ensured when, during the monitoring period, the disinfection temperature is continuously exceeded for the entire disinfection period.

The monitoring period starts as soon as the temperature at the allocated sensor falls below the disinfection temperature. If the monitoring period ends, the demand activates the backup heating. The disinfection period starts when the temperature at the allocated sensor exceeds the disinfection temperature.

Thermal disinfection can only be completed when the disinfection temperature is exceeded for the duration of the disinfection period without any interruption.

The parameter **Cancellation** is used for adjusting the period after which the backup heating is cancelled. If the backup heating is cancelled, an error message is displayed. Thermal disinfection is cancelled.

Starting time delay

If the starting delay option is activated, a starting time for the thermal disinfection with starting delay can be adjusted. The activation of the backup heating is then delayed until that starting time after the monitoring period has ended.

If the monitoring period ends, for example, at 12:00 o'clock, and the starting time has been set to 18:00, the reference relay will be energised with a delay of 6 hours at 18:00 instead of 12:00 o'clock.

With the **TD hold. off** option, thermal disinfection can be deactivated for a phase of absence.

➔ In order to adjust the days of absence, press and hold down microbutton  for 3 s.

With the **BAS off** option, the thermal disinfection can be switched from automatic mode to **Off** by means of the operating mode switch.

Heating / Opt. functions / Add new function / Th. Disinfection

Adjustment channel	Description	Adjustment range / selection	Factory setting
Demand	Demand relay selection	system dependent	system dependent
Mode	Demand mode	Standard, Demand	Standard
Circulating pump	Circulating pump option	Yes, No	No
Output	Circulating pump output selection	system dependent	system dependent
Sensor	Disinfection sensor selection	system dependent	system dependent
Interval	Monitoring period	0 ... 30, 1 ... 23 (dd:hh)	1d 0h
Temperature	Disinfection temperature	45 ... 90 °C	60 °C
Duration	Disinfection period	0.5 ... 24.0 h	1.0 h
Cancellation	Cancellation option	Yes, No	No
Cancellation	Cancellation interval	1.0 ... 48.0 h	2.0 h
Start. time	Starting delay option	Yes, No	No

Adjustment channel	Description	Adjustment range / selection	Factory setting
Start. time	Starting time	00:00 ... 23:30	20:00
Hyst. off	Switch-off hysteresis	2 ... 20K	5 K
Hyst. on	Switch-on hysteresis	1 ... 19K	2 K
TD holid. off	Function off when holiday function is active	Yes, No	No
BAS off	Operating mode switch off option	Yes, No	No
Sensor	Allocation operating mode switch input	system dependent	system dependent
Funct.	Activation / Deactivation	Activated, Deactivated, Switch	Activated
Sensor	Switch input selection	-	-

When the **Timer** option is activated, a timer is indicated in which time frames for the function can be adjusted.



Note

For information on timer adjustment see page 13.

With the **Man. heating** option, DHW heating can be activated outside the adjusted time frame once by means of a switch, if the temperature has fallen below the switch-off value.

With the **DHW holid. off** option, DHW heating can be deactivated for a phase of absence.

➔ In order to adjust the days of absence, press and hold down microbutton  for 3 s.

With the **BAS off** option, DHW heating can be switched from automatic mode to **Off** by means of the operating mode switch.

If **SFB off** is activated, DHW heating is suppressed when a selected solid fuel boiler is active.

Heating / Opt. functions / Add new function / DHW heating

Adjustment channel	Description	Adjustment range / selection	Factory setting
Demand	Output selection demand	system dependent	-
Mode	Demand mode	Standard, Demand	Standard
Pump/valve	Loading pump/valve option	Yes, No	No
Output	Output selection loading pump	system dependent	-
Overrun time	Overrun option	Yes, No	No
Duration	Overrun time	1 ... 10 min	1 min
Mode	Operating mode	Zone, Therm.	Therm.
Sensor 1	Allocation reference sensor 1	system dependent	system dependent
Sensor 2	Allocation reference sensor 2 (if Mode = Zone)	system dependent	system dependent
TO _{on}	Switch-on temperature	0 ... 94 °C	40 °C
TO _{off}	Switch-off temperature	1 ... 95 °C	45 °C
Timer	Timer function	Yes, No	No
Man. heating	Manual heating option	Yes, No	No
Sensor	Switch input selection	system dependent	system dependent
DHW holid. off	Function off when holiday function is active	Yes, No	No

DHW heating

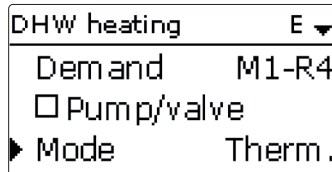

This function is used for demanding backup heating for heating the DHW store.

If the **Pump/valve** option is activated, another adjustment channel appears, in which an output can be allocated to the pump/valve. The allocated output will switch on and off with the demand relay.

If the **Overrun** time option is activated, the loading pump remains switched on for the adjusted duration after the demand relay has been switched off.

For the DHW heating, 2 modes are available:

Thermal mode

The allocated demand relay switches on when the temperature at the allocated sensor 1 falls below the adjusted switch-on temperature. If the temperature at the allocated sensor 1 exceeds the adjusted switch-off temperature, the relay switches off.

Zone mode

In this mode, a further sensor can be selected. The switch-on, or the switch-off conditions respectively, then have to be fulfilled at both sensors in order for the output to be switched on or off.

Adjustment channel	Description	Adjustment range / selection	Factory setting
BAS off	Operating mode switch off option	Yes, No	No
Sensor	Allocation operating mode switch input	system dependent	system dependent
SFB off	Solid fuel boiler off option	Yes, No	No
SFB	Allocation solid fuel boiler	all solid fuel boilers	-
Funct.	Activation / Deactivation	Activated, Deactivated, Switch	Activated
Sensor	Switch input selection	-	-

DHW preheating

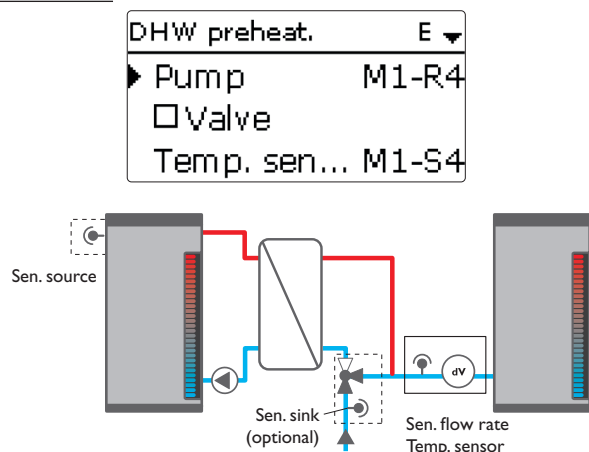

This function uses heat from a buffer store to heat the cold water inlet of the DHW store.

The controller monitors the flow rate at the selected flow rate sensor: If a flow rate is detected, the pump switches on with the starting speed.

If the temperature at the temperature sensor selected exceeds the adjusted DHW maximum temperature, the speed decreases by the increment value. The interval to the next measurement and adaptation can be adjusted by means of the parameter **Delay**.

If the DHW maximum temperature is not reached after the delay time has elapsed, the speed is increased by the increment value. The speed is not increased or decreased respectively within the hysteresis.

If the **ΔT function** is activated, the pump switches on only if **ΔT_{on}** is exceeded, and switches off if the temperature difference falls below **ΔT_{off}** .

If the **Valve** option is activated, the output selected is activated when the pump is activated.

Heating / Opt. functions / Add new function / DHW preheat.

Adjustment channel	Description	Adjustment range / selection	Factory setting
Pump	Output selection pump	system dependent	-
Valve	Valve option	Yes, No	No
Valve	Output selection valve	system dependent	-
Temp. sensor	Temperature sensor	system dependent	-
Sen. flow rate	Flow rate sensor	system dependent	-
TMax DHW	DHW maximum temperature	20 ... 90 °C	60 °C
Start. speed	Starting speed DHW preheating	20 ... 100%	50%
Increment	Increment speed adaptation	1 ... 100%	10%
Hysteresis	Hysteresis speed adaptation	0,5 ... 10,0 K	5,0 K
Delay	Delay time	1 ... 10 s	5 s
ΔT function	Activation ΔT function	Yes, No	No
ΔT_{on}	Switch-on temperature difference	1,0 ... 50,0 K	5,0 K
ΔT_{off}	Switch-off temperature difference	0,5 ... 49,5 K	3,0 K
Sen. source	Heat source sensor selection	system dependent	-
Sen. sink	Heat sink sensor selection	system dependent	-
Funct.	Activation / Deactivation	Activated, Deactivated, Switch	Activated
Sensor	Switch input selection	-	-

Circulation

Circulation	E ▾
▶ Output	M1-R4
Type	Thermal
Sensor	M1-S4

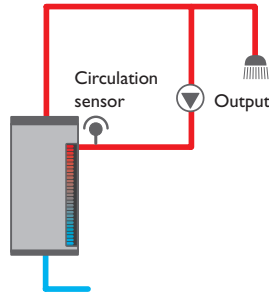

This function can be used for controlling a circulation pump.

For the control logic, 5 variants are available:

- Thermal
- Timer
- Thermal + Timer
- Demand
- Demand + Timer

Thermal

The temperature at the allocated sensor is monitored. The allocated output switches on when the temperature falls below the adjusted switch-on temperature. If the temperature exceeds the switch-off temperature, the output switches off.

Timer

The output switches on during the adjusted time frames, outside of them it switches off.

Thermal + Timer

The output operates when the switch-on conditions of both above-mentioned variants are fulfilled.

Demand

The allocated flow switch is monitored for circuit continuity. If circuit continuity is detected at the flow switch, the output switches on for the adjusted runtime. After the runtime has ended, the output switches off. During the adjusted break time, the output remains switched off even if continuity is detected at the allocated sensor.

Demand + Timer

The output operates when the switch-on conditions of both above-mentioned variants are fulfilled.

When the **Timer**, **Therm.+Timer** or **Dem.+Timer** variant is activated, a timer is indicated in which time frames for the function can be adjusted.



Note

If the flow switch is connected to the input S1 ... S4, continuity must be detected for at least 5 s for the controller to react, 1 s if the flow switch is connected to the impulse input.



Note

For information on timer adjustment see page 13.

Heating / Opt. functions / Add new function / Circulation

Adjustment channel	Description	Adjustment range / selection	Factory setting
Output	Output selection	system dependent	system dependent
Type	Variant	Demand, Thermal, Timer, Therm.+Timer, Dem.+Timer	Thermal
Sensor	Circulation sensor selection	system dependent	system dependent
TO _n	Switch-on temperature	10 ... 59 °C	40 °C
TO _{ff}	Switch-off temperature	11 ... 60 °C	45 °C
Timer	Timer function	Yes, No	No
Delay	Demand switch-on delay	0 ... 3 s	0 s
Runtime	Circulation pump runtime	01:00 ... 15:00 min	03:00 min
Break time	Circulation pump break time	10 ... 60 min	30 min
Funct.	Activation / Deactivation	Activated, Deactivated, Switch	Activated
Sensor	Switch input selection	-	-

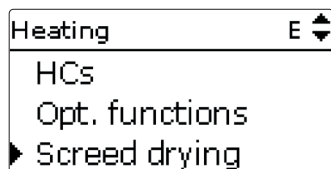

This function is used for time- and temperature-controlled screed drying in selectable heating circuits.

The heating circuits can be selected in the **Heating / Screed drying** menu. At the end of this menu, the function can be triggered by using **Start**.

The controller will automatically change to the screed drying status menu. The current **Phase** will be indicated on the display and the **Remaining time** will be indicated as a countdown (dd:hh). During this process, the operating control LED flashes yellow.

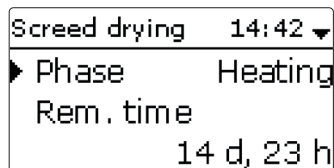

At the end of the menu, **Cancel** will be indicated instead of start. If Cancel is selected, screed drying will be cancelled immediately.

At the beginning of the screed drying function, the heating circuits selected are put into operation for the adjusted rise time with the starting temperature as the set flow temperature. Afterwards, the set flow temperature increases in steps by the adjustable rise value for the duration of the adjustable rise time until the holding temperature is reached. After the holding time has elapsed, the set flow temperature is reduced in steps until the starting temperature is reached again.

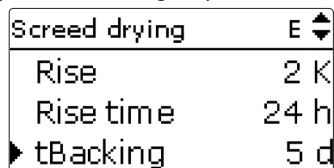

If the set flow temperature is not reached within 24 hours or after the rise time respectively, or if it is constantly exceeded, the screed drying function will be cancelled.

The heating circuit switches off and an error message is displayed. The operating control LED glows red.

Error 1: flow sensor defective

Error 2: the flow temperature is higher than the maximum flow temperature + 5 K for over 5 min

Error 3: the flow temperature is higher than the holding temperature + rise value for over 30 min

Error 4: the flow temperature is higher than the set flow temperature + rise value for over 2 h

Error 5: the flow temperature is lower than the set flow temperature - rise value for over a rise time period

During screed drying of the heating circuits selected, the other heating circuits run corresponding to their operating modes.

The escape button can be used any time for changing to the home screen of the controller in order to carry out adjustments.

When the screed drying function has been successfully completed, the corresponding heating circuits will change to the operating mode **Off**.

Screed drying will automatically be deactivated.



Note

Make sure the heating circuits are supplied with heat from a heat source (backup heating).



Note

If a MicroSD card has been inserted into the slot, a screed protocol will be generated.

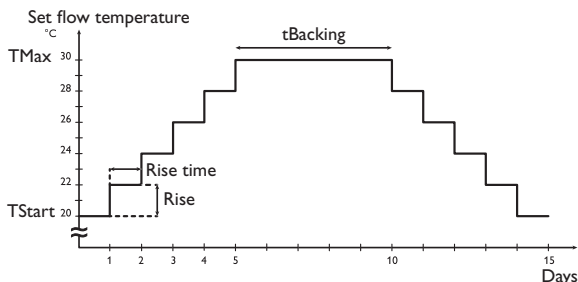

The diagram shows the parameters of the screed drying with the factory settings.

Heating / Screed drying

Adjustment channel	Description	Adjustment range / selection	Factory setting
HCS	Heating circuit selection	HC 1 ... 7	system dependent
TStart	Starting temperature	10 ... 30 °C	20 °C
TMax	Holding temperature	20 ... 60 °C	30 °C
Rise	Rise value	1 ... 10 K	2 K
Rise time	Rise duration	1 ... 24 h	24 h
tBacking	TMax holding time	1 ... 20 d	5 d
Start	Activation / Deactivation	Yes, No	No

9 Arrangement

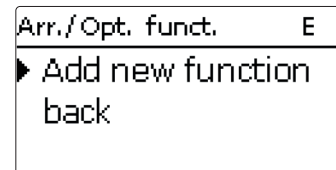

In this menu, all adjustments for the non-heating part of the arrangement can be made.

In combination with extension modules, up to 16 optional functions can be selected and adjusted.

9.1 Optional functions

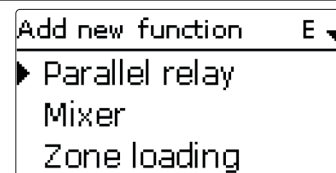

In this menu, optional functions can be selected and adjusted for the arrangement. The kind and number of optional functions offered depends on the previous adjustments.



Note

For further information about adjusting optional functions, see page 15.

Parallel relay

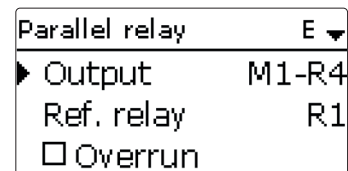

This function can be used for operating an allocated output alongside a selected reference relay. With this function, e.g. a valve can be controlled in parallel to the pump via a separate output.

If the **Overrun** option is activated, the output remains switched on for the adjusted overrun time after the reference relay has been switched off.

If the **Delay** option is activated, the output is energised after the adjusted duration has elapsed. If the reference relay is switched off again during the delay time, the parallel output is not be switched on at all.



Note

If a relay is in the manual mode, the selected output will not be energised.

Arrangement / Opt. functions / Add new function / Parallel relay

Adjustment channel	Description	Adjustment range / selection	Factory setting
Output	Output selection	system dependent	system dependent
Ref. relay	Reference relay selection	system dependent	-
Overrun	Overrun option	Yes, No	No
Duration	Overrun time	1 ... 30 min	1 min
Delay	Delay option	Yes, No	No
Duration	Delay time	1 ... 30 min	1 min
Funct.	Activation / Deactivation	Activated, Deactivated, Switch	Activated
Sensor	Switch input selection	-	-

Mixer

Mixer	E
Mixer cl.	M1-R3
Mixer op.	M1-R4
Sensor	S4

This function can be used to adjust the actual flow temperature to the desired mixer target temperature. The mixer will be opened or closed in pulses depending on this deviation. The mixer will be controlled with the adjustable interval. The pause is determined by the difference between the actual value and the set value.

Arrangement / Opt. functions / Add new function / Mixer

Adjustment channel	Description	Adjustment range / selection	Factory setting
Mixer cl.	Output selection mixer closed	system dependent	system dependent
Mixer op.	Output selection mixer open	system dependent	system dependent
Sensor	Sensor selection	system dependent	system dependent

Adjustment channel	Description	Adjustment range / selection	Factory setting
TMixer	Mixer target temperature	0 ... 130 °C	60 °C
Interval	Mixer interval	1 ... 20 s	4 s
Funct.	Activation / Deactivation	Activated, Deactivated, Switch	Activated
Sensor	Switch input selection	-	-

Zone loading

Zone loading	E
Output	M1-R5
Sensor top	S3
Sensor base	S4

This function can be used for loading a store zone between 2 sensors. For monitoring the switch-on and switch-off conditions, 2 sensors are used. The switch-on and switch-off temperatures are used as reference parameters.

If the measured temperatures at both allocated sensors fall below the adjusted switch-on temperature, the output will be energised. The output will be switched off again if the temperature at both sensors has exceeded the switch-off temperature. If one of the two sensors is defective, zone loading is cancelled or suppressed.



Note

For information on timer adjustment see page 13.

Arrangement / Opt. functions / Add new function / Zone loading

Adjustment channel	Description	Adjustment range / selection	Factory setting
Output	Output selection	system dependent	system dependent
Sensor top	Top sensor selection	system dependent	system dependent
Sensor base	Base sensor selection	system dependent	system dependent
TOn	Switch-on temperature	0 ... 94 °C	45 °C
TOff	Switch-off temperature	1 ... 95 °C	60 °C
Timer	Timer function	Yes, No	No
Funct.	Activation / Deactivation	Activated, Deactivated, Switch	Activated
Sensor	Switch input selection	-	-

Error relay

Error relay	E
▶ Output	M1-R5
Funct.	Activated
Save function	

This function can be used for operating an output in case of an error. Thus, e.g. a signalling device can be connected in order to signal errors.

If the error relay function is activated, the allocated output will operate when a fault occurs. If the flow rate monitoring and/or pressure monitoring function is additionally activated, the allocated output will also operate in case of a flow rate or pressure error.

Arrangement / Opt. functions / Add new function / Error relay

Adjustment channel	Description	Adjustment range / selection	Factory setting
Output	Output selection	system dependent	system dependent
Funct.	Activation / Deactivation	Activated, Deactivated, Switch	Activated
Sensor	Switch input selection	-	-

Heat exchange

Heat exchange	E
▶ Output	M1-R4
Sen. source	S3
Sen. sink	S4

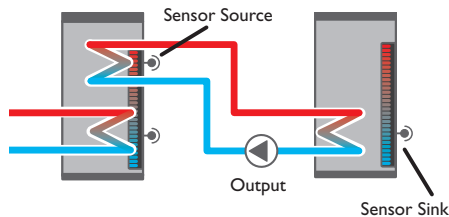

This function can be used for transferring heat from a heat source to a heat sink. The allocated output is energised when all switch-on conditions are fulfilled:

- the temperature difference between the allocated sensors has exceeded the switch-on temperature difference
 - the temperature difference between the allocated sensors has not fallen below the switch-off temperature difference
 - the temperature at the heat source sensor has exceeded the minimum temperature
 - the temperature at the heat sink sensor is below the maximum temperature
 - one of the adjusted time frames is active (if the **Timer** option is selected)
- If the temperature difference exceeds the adjusted set value by 1/10 of the rise value, the pump speed increases by one step (1 %).

When the **Timer** option is activated, a timer is indicated in which time frames for the function can be adjusted.



Note

For information on timer adjustment see page 13.

Arrangement / Opt. functions / Add new function / Heat exchange

Adjustment channel	Description	Adjustment range / selection	Factory setting
Output	Output selection	system dependent	system dependent
Sen. source	Heat source sensor selection	system dependent	system dependent
Sen. sink	Heat sink sensor selection	system dependent	system dependent
ΔT_{On}	Switch-on temperature difference	1.0 ... 30.0 K	6.0 K
ΔT_{Off}	Switch-off temperature difference	0.5 ... 29.5 K	4.0 K
ΔT_{Set}	Set temperature difference	1.5 ... 40.0 K	10.0 K
TMax	Maximum temperature of the store to be loaded	10 ... 95 °C	60 °C
TMin	Minimum temperature of the store to be discharged	10 ... 95 °C	10 °C
Timer	Timer function	Yes, No	No
Funct.	Activation / Deactivation	Activated, Deactivated, Switch	Activated
Sensor	Switch input selection	-	-

Solid fuel boiler	E
▶ Output	M1-R4
Sen. boiler	S3
Sen. store	S4

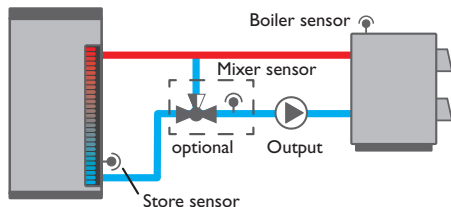

This function can be used for transferring heat from a solid fuel boiler to a store.

The allocated output is energised when all switch-on conditions are fulfilled:

- the temperature difference between the allocated sensors has exceeded the switch-on temperature difference
- the temperature difference between the allocated sensors has not fallen below the switch-off temperature difference
- the temperature at the solid fuel boiler sensor has exceeded the minimum temperature
- the temperature at the store sensor is below the maximum temperature

When the set temperature difference is exceeded, pump speed control starts. For every deviation by 1/10 of the adjusted rise value, the pump speed will be adjusted by 1%.

If the **Target temp.** option is activated, the pump speed control logic will change. The controller will remain at the minimum pump speed until the temperature at the allocated sensor exceeds the adjusted target temperature.

The **Mixer** option can be used to keep the boiler return temperature above **TMin boiler**. The mixer will be controlled with the adjustable interval.

Arrangement / Opt. functions / Add new function / Solid fuel boiler

Adjustment channel	Description	Adjustment range / selection	Factory setting
Output	Output selection	system dependent	system dependent
Sen. boiler	Solid fuel boiler sensor selection	system dependent	system dependent
Sen. store	Store sensor selection	system dependent	system dependent
ΔT_{on}	Switch-on temperature difference	2.0 ... 30.0 K	6.0 K
ΔT_{off}	Switch-off temperature difference	1.0 ... 29.0 K	4.0 K
ΔT_{Set}	Set temperature difference	3.0 ... 40.0 K	10.0 K
TStoremax	Maximum temperature	4 ... 95 °C	60 °C
TMin boiler	Minimum temperature	4 ... 95 °C	60 °C
Target temp.	Target temperature option	Yes, No	No
Targ. temp.	Target temperature	30 ... 85 °C	65 °C
Sensor	Target temperature reference sensor	system dependent	system dependent
Mixer	Mixer option	Yes, No	No
Mixer cl.	Output selection mixer closed	system dependent	system dependent
Mixer op.	Output selection mixer open	system dependent	system dependent
Sensor	Mixer sensor allocation	system dependent	system dependent
ΔT_{Open}	Temperature difference mixer open	0.5 ... 30.0 K	5.0 K
ΔT_{Closed}	Temperature difference mixer closed	0.0 ... 29.5 K	2.0 K
Interval	Mixer interval	1 ... 20 s	4 s
Funct.	Activation / Deactivation	Activated, Deactivated, Switch	Activated
Sensor	Switch input selection	-	-

Return preheating

Ret. preheat.	E ▾
▶ Output	M1-R4
Sen. return	S4
Sen. source	S3

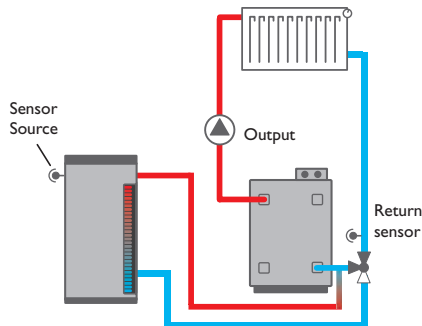

This function can be used for transferring heat from a heat source to the heating circuit return.

The allocated output is energised when all switch-on conditions are fulfilled:

- the temperature difference between the allocated sensors has exceeded the switch-on temperature difference
- the temperature difference between the allocated sensors has not fallen below the switch-off temperature difference
- if **Summer off** is activated, the temperature at the outdoor temperature sensor falls below the adjusted outdoor temperature value

With the summer switch-off option, the return preheating can be suppressed outside the heating period.

Arrangement / Opt. functions / Add new function / Ret. preheat.

Adjustment channel	Description	Adjustment range / selection	Factory setting
Output	Output selection	system dependent	system dependent
Sen. return	Return sensor selection	system dependent	system dependent

Adjustment channel	Description	Adjustment range / selection	Factory setting
Sen. source	Heat source sensor selection	system dependent	system dependent
ΔT_{on}	Switch-on temperature difference	2.0 ... 30.0K	6.0 K
ΔT_{off}	Switch-off temperature difference	1.0 ... 29.0K	4.0 K
Summer off	Summer switch-off option	Yes, No	No
Sensor	Outdoor sensor selection	system dependent	system dependent
TOff	Switch-off temperature	10 ... 60 °C	20 °C
Funct.	Activation / Deactivation	Activated, Deactivated, Switch	Activated
Sensor	Switch input selection	-	-

Function block

Function block	E ▾
▶ Output	M1-R4
<input type="checkbox"/> Thermostat a	
<input type="checkbox"/> Thermostat b	

In addition to the pre-defined optional functions, function blocks consisting of thermostat functions, timer, differential, reference output and flow rate functions are available. With the help of these function blocks, further components and functions respectively can be controlled.

To each function block, sensors and outputs available can be allocated.

Within a function block the functions are interconnected (AND gate). This means that the switching conditions of all the activated functions have to be fulfilled for switching the allocated output. As soon as one condition is not fulfilled, the output will switch off.

Thermostat function

The switching condition for the thermostat function is considered fulfilled when the adjusted switch-on temperature ($T_{h(x) on}$) is reached.

The switching condition for the thermostat function is considered unfulfilled when the adjusted switch-off temperature ($T_{h(x) off}$) is reached.

Allocate the reference sensor in the **Sensor** channel.

Adjust the maximum temperature limitation with ($T_{h(x) off} > T_{h(x) on}$) and the minimum temperature limitation with ($T_{h(x) on} > T_{h(x) off}$). The temperatures cannot be set to an identical value.

ΔT function

The switching condition for the ΔT function is considered fulfilled when the adjusted switch-on temperature (ΔT_{on}) is reached.

The switching condition for the ΔT function is no longer considered fulfilled when the adjusted switch-off temperature (ΔT_{off}) is reached.

The ΔT function is equipped with a speed control function. A set temperature difference and a minimum speed can be adjusted. The non-adjustable rise value is 2 K.

Reference output

Up to 5 Reference outputs can be selected. Whether the reference outputs are to be switched in series (AND), in parallel (OR), in series + inverted (NAND) or in parallel + inverted (NOR) can be adjusted in the **Mode** channel.

OR mode

If at least one of the reference outputs is switched on, the switching condition for the reference output function is considered fulfilled.

If none of the reference outputs is switched on, the switching condition for the reference output function is considered unfulfilled.

NOR mode

If none of the reference outputs is switched on, the switching condition for the reference output function is considered fulfilled.

If at least one of the reference outputs is switched on, the switching condition for the reference output function is considered unfulfilled.

AND mode

If all reference outputs are switched on, the switching condition for the reference output function is considered fulfilled.

If at least one of the reference outputs is switched off, the switching condition for the reference output function is considered unfulfilled.

NAND mode

If at least one of the reference outputs is switched off, the switching condition for the reference output function is considered fulfilled.

If all reference outputs are switched on, the switching condition for the reference output function is considered unfulfilled.

Flow rate

If the adjusted switch-on flow rate is exceeded, the switching condition for the flow rate function is considered fulfilled.

If the flow rate falls below the adjusted switch-off value, the condition for the flow rate function is no longer considered fulfilled.

The flow rate sensor for this function can be selected.



Note

For information on timer adjustment see page 13.

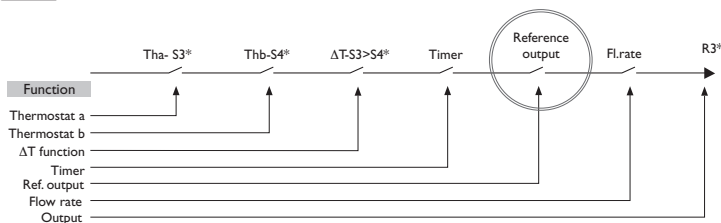

* exemplary selection, sensors and outputs can be freely selected

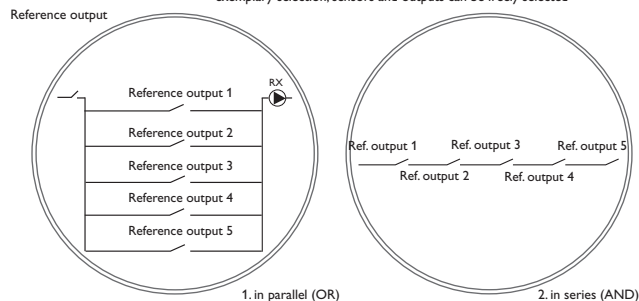

Arrangement / Opt. functions / Add new function / Function block

Adjustment channel	Description	Adjustment range / selection	Factory setting
Output	Output selection	system dependent	system dependent
Thermostat a	Thermostat function a	Yes, No	No
Th-a on	Switch-on temperature thermostat a	-40... +250 °C	+40 °C
Th-a off	Switch-off temperature thermostat a	-40... +250 °C	+45 °C
Sensor	Sensor thermostat a	system dependent	system dependent
Thermostat b	Thermostat function b	Yes, No	No
Th-b on	Switch-on temperature thermostat b	-40... +250 °C	+40 °C
Th-b off	Switch-off temperature thermostat b	-40... +250 °C	+45 °C
Sensor	Sensor thermostat b	system dependent	system dependent
ΔT function	Differential function	Yes, No	No
ΔT_{on}	Switch-on temperature difference	1.0... 50.0 K	5.0 K
ΔT_{off}	Switch-off temperature difference	0.5... 49.5 K	3.0 K

Adjustment channel	Description	Adjustment range / selection	Factory setting
ΔT_{Set}	Set temperature difference	3 ... 100K	10 K
Sen. source	Heat source sensor	system dependent	system dependent
Sen. sink	Heat sink sensor	system dependent	system dependent
Timer	Timer function	Yes, No	No
Ref. output	Reference output function	Yes, No	No
Mode	Reference output mode	OR, AND, NOR, NAND	OR
Output	Reference output 1	all outputs	-
Output	Reference output 2	all outputs	-
Output	Reference output 3	all outputs	-
Output	Reference output 4	all outputs	-
Output	Reference output 5	all outputs	-
Flow rate	Flow rate function	Yes, No	No
Fl. on	Switch-on flow rate	1.0 ... 999.0 l/min	8.0 l/min
Fl. off	Switch-off flow rate	0.5 ... 998.5 l/min	7.5 l/min
Sen. flow rate	Flow rate sensor	system dependent	-
Funct.	Activation / Deactivation	Activated, Deactivated, Switch	Activated
Sensor	Switch input selection	-	-

Return mixing function

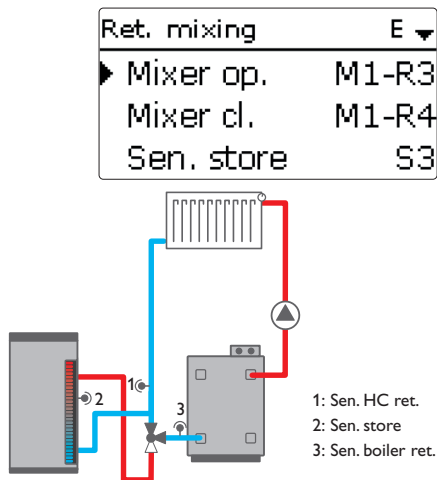

This function can be used for heating backup.

Heat from the store is mixed into the heating circuit return by means of a mixing valve in order to add heat to the heating circuit. The controller compares the temperature at the selected store sensor to the heating circuit return temperature. If the store temperature exceeds the heating circuit return temperature by the switch-on temperature difference, the mixer will be used to add heat from the store to the heating circuit return. The mixer will be opened or closed in pulses depending on this deviation. The mixer will be controlled with the adjustable interval. The pause is determined by the difference between the actual value and the set value.

Thus, the heating circuit return temperature increases by the ΔT_{Set} value. The adjustable maximum boiler return temperature limits the mixing temperature. If the store temperature falls below the heating circuit return temperature by the switch-off temperature difference, the mixer will close.

Heating circuit Internal

If **Internal** is selected in the **HC** parameter, the return mixing function will only become active when the selected heating circuit of the controller is active, too. For this purpose, the heating circuit selected has to be controlled by the controller or by a module connected.

Heating circuit External

If **External** is selected in the **HC** parameter, the controller calculates the status of the external heating circuit by means of the following parameters. The runtime defines the time needed for the mixer to switch from its initial position to the end position. The **Detection** parameter determines the opening angle of the mixer when the heating circuit is to be checked for activity. The **Time** defines the point in time at which the mixer is completely closed for adjustment every 24 hours.

Arrangement / Opt. functions / Add new function / Ret. mixing

Adjustment channel	Description	Adjustment range / selection	Factory setting
Mixer op.	Output selection mixer open	system dependent	system dependent
Mixer cl.	Output selection mixer closed	system dependent	system dependent
Sen. store	Store sensor allocation	system dependent	system dependent
Sen. HC ret.	HC return sensor allocation	system dependent	system dependent
Sen. boiler ret.	Boiler return sensor allocation	system dependent	system dependent
ΔT_{On}	Switch-on temperature difference	1.0 ... 25.0K	5.0 K
ΔT_{Off}	Switch-off temperature difference	0.5 ... 24.0K	3.0 K
ΔT_{Set}	Set temperature difference	-20 ... +25 K	+7 K
TMax	Maximum boiler return temperature	10 ... 80 °C	60 °C
Interval	Mixer interval	1 ... 20 s	2 s

Adjustment channel	Description	Adjustment range / selection	Factory setting
HC	Detection controller heating circuit active	Internal, External	Internal
HC	Heating circuit allocation	HC 1...7	-
Runtime	Mixer runtime	10 ... 600 s	105 s
Detection	Mixer opening degree	50 ... 90%	60%
Time	Time of automatic adjustment	00:00 ... 23:45	00:00
Funct.	Activation / Deactivation	Activated, Deactivated, Switch	Activated
Sensor	Switch input selection	-	-

Flow rate monitoring

Flow rate mon.	E ▾
▶ Sensor	IMP
Ref. relay	R4
Time	30 s

This function can be used to detect malfunctions that impede the flow rate and to switch off the corresponding output. This will prevent system damage, e.g. through a dry run of the pump.

If the flow rate monitoring function is activated, an error message will appear when no flow rate is detected at the allocated flow rate sensor after the delay time has elapsed.

If a reference relay has been selected, the flow rate monitoring function will become active when the allocated relay switches on. In the case of an error, the reference relay will be blocked.

The error message will appear both in the **Status / Messages** menu and in the **Status / Arrangement / Flow rate mon.** menu. It can be acknowledged in the **Status / Arrangement / Flow rate mon.** menu only.

Arrangement / Opt. functions / Add new function / Flow rate mon.

Adjustment channel	Description	Adjustment range / selection	Factory setting
Sensor	Flow rate sensor selection	system dependent	-
Ref. relay	Reference relay selection	system dependent	-
Time	Delay time	1 ... 300s	30 s
Funct.	Activation / Deactivation	Activated, Deactivated, Switch	Activated
Sensor	Switch input selection	-	-

10 HQM

HQM	E	Add new function	E
▶ Add new function		▶ HQM	
back		Impulse counter	
		back	

In this menu, up to 7 calorimeters including 1 impulse counter can be activated and adjusted.



Note

The adjustment of the functions is similar to the adjustment of optional functions, see page 15.

Calorimeter

HQM	E ▾
▶ Sen. flow	S2
Sen. ret.	S4
<input type="checkbox"/> Sen. flow rate	

If the Flow rate sensor option is activated, an impulse input or, if available, a Grundfos Direct Sensor™ can be selected. Additionally, the **Reference relay** option can be activated. Heat quantity balancing is then only takes place if the allocated relay is active.

The Grundfos Direct Sensor™ is only available if it has been previously registered in the **Basic settings** menu. The impulse rate must be adjusted in that menu as well.

If the flow rate sensor option is deactivated, the controller calculates the heat quantity by means of a fixed flow rate value. This is called heat quantity balancing. For this purpose, the flow rate must be read from the flowmeter at 100% pump speed and adjusted in the adjustment channel **Fl.rate**. In addition to that, a relay must be allocated. Heat quantity balancing is in effect whenever the allocated relay is active.

In the adjustment channel **Fluid type** the heat transfer fluid must be selected. If either propylene glycol or ethylene glycol is selected, the adjustment channel **Concentration** is indicated in which the antifreeze ratio of the heat transfer fluid can be adjusted.

If a calorimeter is being configured for the first time or after the overall quantity has been reset, the parameter **Carryover** appears. A former value which is to be added to the overall quantity can be entered.

When the **Alternative unit** is activated, the controller converts the heat quantity into the quantity of fossil fuels (coal, oil or gas) saved, or the CO₂ emission saved respectively. The alternative unit can be selected. A conversion factor must be adjusted for the calculation. The conversion factor depends on the arrangement in use and has to be determined individually.

HQM /Add new function /HQM

Adjustment channel	Description	Adjustment range / selection	Factory setting
Sen. flow	Flow sensor selection	system dependent	system dependent
Sen. ret.	Return sensor selection	system dependent	system dependent
Sen. flow rate	Flow rate sensor option	Yes, No	No
Fl.rate	Flow rate (only if Sen. flow rate = No)	1.0 ... 500.0 l/min	3.0 l/min
Relay	Relay selection	system dependent	-
Sen. flow rate	Flow rate sensor selection	system dependent	-
Ref. relay	Reference relay option	Yes, No	No
Relay	Reference relay allocation	system dependent	system dependent
Fluid type	Heat transfer fluid	Tyfo LS, Propyl., Ethyl., Water	Propyl.
Concentr.	Glycol concentration in the heat transfer fluid (only if fluid type = propylene glycol or ethylene glycol)	20 ... 70 %	40 %
Alternative unit	Alternative unit option	Yes, No	No
Unit	Alternative display unit	Coal, Gas, Oil, CO ₂	CO ₂
Factor	Conversion factor	0.0000001 ... 100.0000000	0.5000000
Carryover	Carryover value (for the first-time configuration or after a HQM reset only)	-	-
Funct.	Activation / Deactivation	Activated, Deactivated, Switch	Activated
Sensor	Switch input selection	-	-

Impulse counter

Impulse counter	E
▶ Input	IMP
Carryover	
Funct.	Activated

With an impulse counter, the impulses of a device with S0 output can be counted, e.g. for balancing the yield of a PV system.

For this purpose, the impulse input of the controller has to be selected in the **Input** channel. If an impulse counter is being configured for the first time or after the overall quantity has been reset, the parameter **Carryover** appears. A former value which is to be added to the overall quantity can be entered.

HQM /Add new function /Impulse counter

Adjustment channel	Description	Adjustment range / selection	Factory setting
Input	Impulse input	IMP	-
Carryover	Carryover value (for the first-time configuration or after a reset only)	-	-
Funct.	Activation / Deactivation	Activated, Deactivated, Switch	Activated
Sensor	Switch input selection	-	-

11 Basic settings

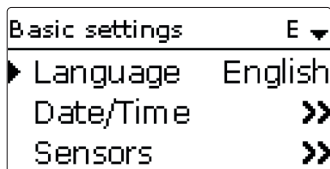

In this menu, all basic parameters for the controller can be adjusted. Normally, these settings have been made during commissioning. They can be subsequently changed in this menu.

Basic settings

Adjustment channel	Description	Adjustment range / selection	Factory setting
Language	Selection of the menu language	Deutsch, English, Français, Español, Italiano, Nederlands, Türkçe, Česky, Polski, Português, Hrvatski, Română, Български, Русский, Suomi, Svenska, Magyar	Deutsch
Date/Time			
Date	Adjustment of the date	01.01.2001 ... 31.12.2050	01.01.2020
Time	Adjustment of the current time	00:00 ... 23:59	-
Auto DST	Daylight savings time selection	Yes, No	Yes
Sensors	Sensors submenu (see page 56)	-	-
Modules	Modules submenu (see page 57)		
Devices	Devices submenu (see page 57)		
Blocking protect.	Blocking protection submenu	-	-
Start. time	Blocking protection starting time	00:00 ... 23:59	12:00
Runtime	Blocking protection runtime	1 ... 30 s	10 s
Units	Units submenu	-	-
Temp. unit	Temperature unit	°C, °F	°C
Vol. unit	Volume unit	Gallons, Litre	Liter
Press. unit	Pressure unit	psi, bar	bar
Energy unit	Energy unit	kWh, MBTU	kWh
Scheme	Scheme selection	0000 ... 0004	0000
Reset	back to factory setting	Yes, No	No

11.1 Sensors

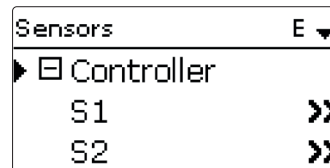

In this submenu, the type of the sensor connected can be adjusted for each individual input. The following types can be selected:

- S1 ... S5: Impulse (S5 only), Switch, Fern (remote control), BAS (operating mode switch), Pt1000, Pt500, KTY, None
- Ga1 RH, RPS, VFS, None

ATTENTION! System damage!



Selecting the wrong sensor type will lead to unwanted control behaviour. In the worst case, system damage can occur!

→ **Make sure that the right sensor type is selected!**

If **KTY**, **Pt500** or **Pt1000** is selected, the channel **Offset** will appear, in which an individual offset can be adjusted for each sensor.



Note

If a sensor is used as the temperature sensor of a function, the sensor types **Switch**, **Fern**, **BAS** and **None** will not be available for the corresponding input.

ATTENTION! Damage to the device!



Sensor inputs which have been set to the sensor type switch can only be used for connecting potential-free switches.

→ **Make sure no voltage is applied!**

If **Switch** is selected, the **Inverted** option will appear and can be used for inverting the behaviour of the switch.



Note

When Grundfos Direct Sensors™ are used, connect the sensor ground common terminal block to PE (see page 8).

Basic settings/Sensors

Adjustment channel	Description	Adjustment range / selection	Factory setting
S1 ... S5	Sensor input selection	-	-
Type	Sensor type selection	Impulse (S5 only), Switch, Fern, BAS, Pt1000, Pt500, KTY, None	Pt1000
Offset	Sensor offset	-15.0 ... +15.0 K	0.0 K
Vol./Imp.	Impulse rate	0.1 ... 100.0 l	1.0 l
Offset	Delete offset	Yes, No	No
Ga1	Analogue Grundfos Direct Sensor™	-	-
Type	Grundfos-Direct-Sensor™ type	RH, RPS, VFS, None	None
Max.	Maximum pressure (if Type = RPS)	0.0 ... 16.0 bar	6 bar
Min.	Minimum flow rate (if Type = VFS)	1 ... 399 l/min	2 l/min
Max.	Maximum flow rate (if Type = VFS)	2 ... 400 l/min	40 l/min
Offset	Sensor offset	-15.0 ... +15.0 K	0.0 K

11.2 Modules

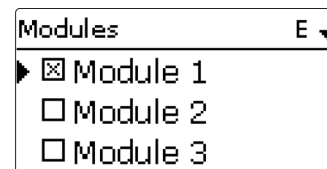

In this menu, up to 5 extension modules can be registered.

All modules connected and acknowledged by the controller are available.

If a module is registered, all its sensor inputs and relay outputs will be available in the corresponding controller menus.

Basic settings / Modules

Adjustment channel	Description	Adjustment range / selection	Factory setting
Module 1 ... 5	Registering external modules	-	-

11.3 Devices

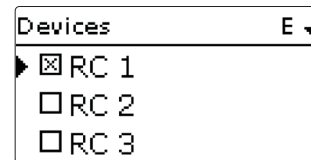

In this menu, up to 7 RC type room control units can be registered (RTS room control unit).

All room control units connected and acknowledged by the controller are available.

If a room control unit is registered, all its sensor inputs will be available in the corresponding controller menus.

Basic settings/Devices

Adjustment channel	Description	Adjustment range / selection	Factory setting
RC 1 ... 7	Registering room control units	-	-

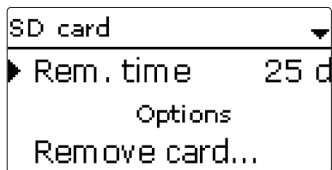

The controller is equipped with a MicroSD card slot for MicroSD memory cards.



Note

The MicroSD card used must be formatted in FAT32.

Firmware updates

The current software can be downloaded from www.resol.com/firmware. When a MicroSD card with a firmware update is inserted, the enquiry **Update?** is indicated on the display.

→ To run the update, select **Yes** and confirm by pressing button (5).

The update will run automatically. The indication **Please wait...** and a progress will bar appear on the display. When the update has been completed, the controller will automatically reboot and run a short initialisation phase.



Note

Only remove the card when the initialisation phase has been completed and the main menu is indicated on the controller display!

→ To skip the update, select **No**.

The controller starts normal operation.



Note

The controller will only recognise a firmware update file if it is stored in a folder named **HCM2** on the first level of the MicroSD card.

→ Create a folder named **HCM2** on the SD card and extract the downloaded ZIP file into this folder.

Starting the logging

1. Insert the MicroSD card into the slot.
2. Adjust the desired logging type and interval.

Logging will start immediately.

Completing the logging process

1. Select the menu item **Remove card...**
2. After **Remove card** is displayed, remove the card from the slot.

When **Linear** is adjusted in the logging type adjustment channel, data logging will stop if the capacity limit is reached. The message **Card full** will be displayed.

If **Cyclic** is adjusted, the oldest data logged onto the card will be overwritten as soon as the capacity limit is reached.



Note

Because of the increasing size of the data packets, the remaining logging time does not decrease linearly. The data packet size can increase, e.g. with the increasing operating hours value.

Storing controller adjustments

→ To store the controller adjustments on the MicroSD card, select the menu item **Save adjustments**.

While the adjustments are being stored, first **Please wait...**, then **Done!** will be indicated on the display. The controller adjustments are stored as a .SET file on the MicroSD card.

Loading controller adjustments

1. To load controller adjustments from a MicroSD card, select the menu item **Load adjustments**.

The **file selection** window will appear.

2. Select the desired .SET file.

While the adjustments are being loaded, first **Please wait...**, then **Done!** will be indicated on the display.



Note

The controller will only recognise .SET files if they are stored in a folder named **HCM2** on the first level of the MicroSD card.



Note

To safely remove the MicroSD card, always select the menu item **Remove card...** before removing the card.

SD card

Adjustment channel	Description	Adjustment range / selection	Factory setting
Remove card...	Safely remove card	-	-
Save adjustments	Save adjustments	-	-
Load adjustments	Load adjustments	-	-
Logging int.	Logging interval	00:01 ... 20:00 (mm:ss)	01:00
Logging type	Logging type	Cyclic, Linear	Linear

13 Manual mode

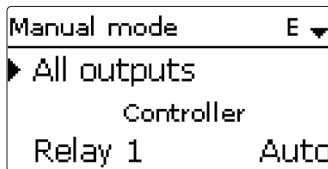

In this menu, the operating mode of all outputs in the controller and in modules connected can be adjusted.

In the **All outputs...** menu, all outputs can be simultaneously switched off (Off) or set to automatic mode (Auto):

Off = Output is switched off (manual mode)

Auto = Output is in automatic mode

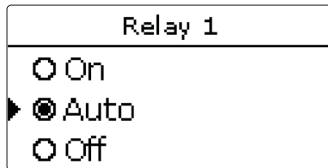

The operating mode can be selected for each individual output, too. The following options are available:

Off = Output is switched off (manual mode)

On = Output is active at 100% speed (manual mode)

Auto = Output is in automatic mode

Min. = Output is active at minimum speed (manual mode)

Max. = Output is active at maximum speed (manual mode)



Note

After service and maintenance work, the relay mode must be set back to **Auto**. In manual mode the control logic is suspended.

Manual mode

Adjustment channel	Description	Adjustment range / selection	Factory setting
All outputs...	Selection operating mode of all relays	Auto, Off	Off
Relay 1 ... X	Operating mode of relay	On, Auto, Off	Auto
Output A ... B	Operating mode of signal output	On, Max., Auto, Min., Off	Auto
Demand 1 (2)	Operating mode of demand	Max., Auto, Min., Off	Auto
Pump 1 (2)	Operating mode of pump	Max., Auto, Min., Off	Auto
Valve 1 (2)	Operating mode of valve	Max., Auto, Min., Off	Auto

14 User code

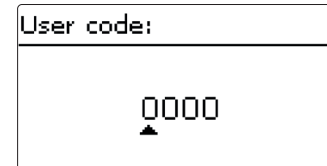

In this menu, a user code can be entered. Each number of the 4-digit code must be individually adjusted and confirmed. After the last digit has been confirmed, the menu automatically jumps to the superior menu level.

To access the menu areas of the installer level, the installer user code must be entered:

Installer: 0262

For safety reasons, the user code should generally be set to the customer code before the controller is handed to the customer!

Customer: 0000

15 Troubleshooting

If a malfunction occurs, a message will appear on the display of the controller.

WARNING! **Danger of electric shock!**
 Upon opening the housing, live parts are exposed!
 → **Always disconnect the device from power supply before opening the housing!**



The controller is protected by a fuse. The fuse holder (which also holds the spare fuse) becomes accessible when the cover is removed. To replace the fuse, pull the fuse holder from the base.

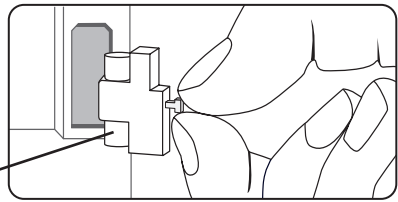

Fuse

Operating control LED flashes red.

Sensor fault. The message **!Sensor fault** instead of a temperature is shown on the sensor display channel.

Short circuit or line break.
 Disconnected temperature sensors can be checked with an ohmmeter. Please check if the resistance values correspond with the table.

°C	°F	Ω			°C	°F	Ω		
		Pt500	Pt1000	KTY			Pt500	Pt1000	KTY
-10	14	481	961	1499	55	131	607	1213	2502
-5	23	490	980	1565	60	140	616	1232	2592
0	32	500	1000	1633	65	149	626	1252	2684
5	41	510	1019	1702	70	158	636	1271	2778
10	50	520	1039	1774	75	167	645	1290	2874
15	59	529	1058	1847	80	176	655	1309	2971
20	68	539	1078	1922	85	185	664	1328	3071
25	77	549	1097	2000	90	194	634	1347	3172
30	86	559	1117	2079	95	203	683	1366	3275
35	95	568	1136	2159	100	212	693	1385	3380
40	104	578	1155	2242	105	221	702	1404	3484
45	113	588	1175	2327	110	230	712	1423	3590
50	122	597	1194	2413	115	239	721	1442	3695

The display is permanently off.

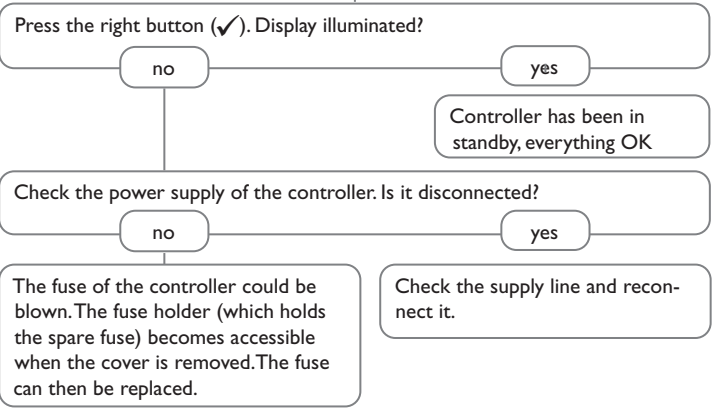

i Note
 For answers to frequently asked questions (FAQ) see www.resol.com.

The heating circuit pump does not work, although this is indicated on the status display.

Display illuminated?

If not, press the right button (✓).
Display illuminated again?

yes

no

There is no current; check fuses / replace them and check power supply.

Does the pump start up in manual operation?

no

yes

The adjusted temperature difference for starting the pump is too high; choose a value which makes more sense.

Is the pump current enabled by the controller?

no

yes

Controller might be defective - replace it.

Is the pump stuck?

yes

Turn the pump shaft using a screwdriver; now passable?

no

Pump is defective - replace it.

Stores cool down at night.

Sufficient store insulation?

yes

no

Increase insulation.

Insulation close enough to the store?

yes

no

Replace insulation or increase it.

Are the store connections insulated?

yes

no

Insulate the connections.

Warm water outflow upwards?

no

yes

Change connection and let the water flow sideways or through a siphon (downwards); less store losses now?

no

yes

o.k.

Does the DHW circulation run for a very long time?

no

yes

Use the circulation pump with timer and switch-off thermostat (energy-efficient circulation).

Circulation pump and blocking valve should be switched off for 1 night; less store losses?

yes

no

Check whether the pumps of the after-heating circuit run at night; check whether the non-return valve is defective; problem?

no

Check the non-return valve in warm water circulation - o.k.

yes

no

Further pumps which are connected to the store must also be checked.

The gravitation circulation in the circulation line is too strong; insert a stronger valve in the non-return valve or an electrical 2-port valve behind the circulation pump; the 2-port valve is open when the pump is activated, otherwise it is closed;

Clean or replace it.

connect pump and 2-port valve electrically in parallel; activate the circulation again. Deactivate pump speed control!

Symbols			
ΔT function.....	52	F	
Numbers		Function block.....	51
0-10V boiler control.....	32	Fuse, replacing of.....	60
A		H	
Antifreeze function.....	40	Heating circuit mixer.....	33
App.....	40	Heating circuit pump.....	33
Automatic mode.....	27	Heating curve.....	34
B		HE pump.....	9
Backup heating, heating circuit.....	40	Holiday.....	29
Boiler control.....	31	I	
C		Interval.....	33
Calorimeter.....	54	L	
Chimney sweeper function.....	11, 40	Lightwheel®.....	11
Circulation.....	51	M	
Commissioning menu.....	20	Manual mode.....	59
Control lamp.....	11	Maximum flow temperature.....	34
Controller adjustments, loading of.....	58	Microbuttons.....	11
Cooling system.....	37	Minimum flow temperature.....	34
Correction modes.....	36	Mixer, optional arrangement function.....	48
Countdown.....	40	Mixer runtime.....	33
D		Modulating heating control.....	32
Data logging.....	58	Modules, registration of.....	57
Day/Night operation.....	35	Mounting.....	6
Day operation, day correction.....	36	N	
Dew point.....	37	Night correction.....	34
DHW priority, heating circuit.....	40	Night operation.....	35
E		O	
Electrical connection.....	8	Operating mode, outputs.....	59
Energy saving operation, heating circuit.....	41	Operating mode switch.....	40
Error messages.....	30	Operation mode.....	27
Error messages, acknowledgement of.....	30	Output selection.....	17, 19
Error relay.....	49		

R

Registering external modules.....	57
Remote access, heating circuit.....	39
Remote control.....	34, 39
Return preheating.....	51
Room control, heating circuit.....	35
Room control unit.....	40
Room control units	57

S

Screed drying	46
Set flow temperature.....	34
Shared relays	31
Solid fuel boiler.....	50
Starting temperature.....	46
Storing controller adjustments	58

T

Technical data.....	5
Thermal disinfection.....	42
Thermostat function	51
Timer	13

V

VBus®	10
-------------	----

Z

Zone loading	48
--------------------	----



Optionales Zubehör | Optional accessories | Accessoires optionnels | Accesorios opcionales | Accessori opzionali:
www.resol.de/4you

Distributed by:

RESOL – Elektronische Regelungen GmbH

Heiskampstraße 10
45527 Hattingen / Germany

Tel.: +49 (0) 23 24 / 96 48 - 0

Fax: +49 (0) 23 24 / 96 48 - 755

www.resol.com

info@resol.com

Important note

The texts and drawings in this manual are correct to the best of our knowledge. As faults can never be excluded, please note:

Your own calculations and plans, under consideration of the current standards and directions should only be basis for your projects. We do not offer a guarantee for the completeness of the drawings and texts of this manual - they only represent some examples. They can only be used at your own risk. No liability is assumed for incorrect, incomplete or false information and / or the resulting damages.

Note

The design and the specifications can be changed without notice.

The illustrations may differ from the original product.

Imprint

This mounting- and operation manual including all parts is copyrighted. Another use outside the copyright requires the approval of **RESOL – Elektronische Regelungen GmbH**. This especially applies for copies, translations, micro films and the storage into electronic systems.

© **RESOL – Elektronische Regelungen GmbH**